



Cite this: *Org. Biomol. Chem.*, 2015, **13**, 207

## The rapid synthesis of oxazolines and their heterogeneous oxidation to oxazoles under flow conditions†

Steffen Glöckner, Duc N. Tran, Richard J. Ingham, Sabine Fenner, Zoe E. Wilson, Claudio Battilocchio and Steven V. Ley\*

Received 2nd October 2014,  
Accepted 27th October 2014

DOI: 10.1039/c4ob02105c

www.rsc.org/obc

A rapid flow synthesis of oxazolines and their oxidation to the corresponding oxazoles is reported. The oxazolines are prepared at room temperature in a stereospecific manner, with inversion of stereochemistry, from  $\beta$ -hydroxy amides using Deoxo-Fluor®. The corresponding oxazoles can then be obtained via a packed reactor containing commercial manganese dioxide.

### Introduction

Oxazolines and oxazoles are important biological scaffolds present within many natural products (Fig. 1).<sup>1,2</sup> Amongst the many synthetic approaches towards these structural motifs, one very useful strategy involves the cyclodehydration of  $\beta$ -hydroxy amides using reagents such as Burgess' reagent,<sup>3</sup> the Mitsunobu reagent,<sup>4</sup> Martin sulfurane,<sup>5</sup>  $\text{Ph}_2\text{-SO-Tf}_2\text{O}$ ,<sup>6</sup>  $\text{PPh}_3\text{-CCl}_4$ <sup>7</sup> or by treatment with fluorinating reagents such as diethylaminosulfur trifluoride (DAST) and Deoxo-Fluor®.<sup>8</sup>

The oxidative aromatisation of oxazolines to the corresponding oxazoles is typically achieved using 1,8-diazabicyclo[5.4.0]undec-7-ene (DBU) and bromotrichloromethane.<sup>8,9</sup> Other reagents such as  $\text{NiO}_2$ ,<sup>10</sup>  $\text{CuBr}_2/\text{DBU}$ ,<sup>11</sup>  $\text{NBS}/h\nu$ ,<sup>12</sup>  $\text{CuBr}$

peroxide<sup>12</sup> or  $\text{O}_2$  gas<sup>13</sup> have also been successfully employed, although largely for the oxidation of C5-unsubstituted oxazoline rings. While manganese(IV) dioxide ( $\text{MnO}_2$ ) has been applied with some success to the preparation of thiazoles from thiazolidines,<sup>14</sup> to date it has not been widely used for the synthesis of oxazoles and only a few examples exist in the literature.<sup>15,16</sup>

We have previously described the preparation of oxazolines in flow during the synthesis of *o*-methyl siphonazole,<sup>9</sup> hennoxazole A<sup>17</sup> and bisoxazoline PyBox chiral ligands.<sup>18</sup> DAST was employed to effect the cyclisation of a  $\beta$ -hydroxy amide to the oxazoline at 70–90 °C, followed by in-line quenching of residual HF. This approach greatly improved the safety profile of the reaction compared to the batch synthesis, as well as providing pure products without need for additional purification. With these benefits in mind, it was decided to further investigate the scope of this flow transformation, employing the more stable Deoxo-Fluor® reagent.

Our experience has shown that manganese dioxide can be simply packed into an Omnifit® column<sup>19</sup> and used successfully as a heterogeneous reagent in flow processes, without the problems usually associated with the use of this reagent in batch synthesis, *i.e.* its tendency to adhere to surfaces and cause blockages.<sup>20</sup> Here we report the development of a flow protocol for the rapid cyclodehydration of a diverse range of  $\beta$ -hydroxy amides using Deoxo-Fluor® and the oxidative aromatisation of the resulting oxazolines to oxazoles using commercial activated and amorphous manganese dioxide.

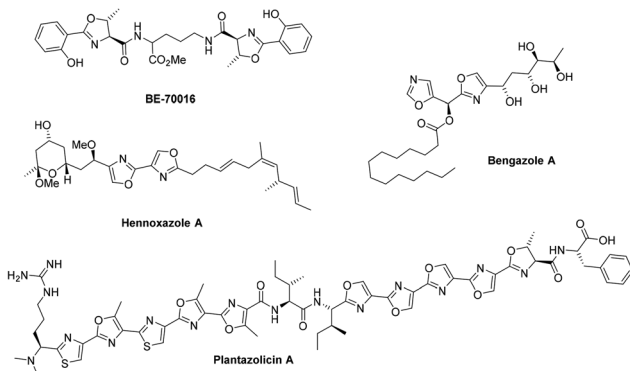

Fig. 1 Oxazoline- and oxazole-containing natural products.

Department of Chemistry, University of Cambridge, Lensfield Road, Cambridge CB2 1EW, UK. E-mail: svl1000@cam.ac.uk; http://www.leygroup.ch.cam.ac.uk/  
† Electronic supplementary information (ESI) available: Analytical characterisation of compounds and spectra. See DOI: 10.1039/c4ob02105c

### Results and discussion

Our initial investigations focused on the flow synthesis of oxazolines, revealing that the use of a slight excess (1.35 eq.)<sup>21</sup> of



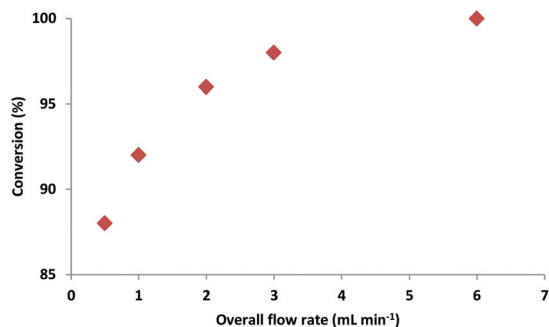
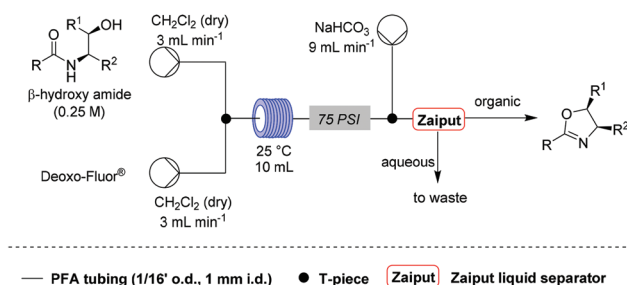

Fig. 2 Effect of flow rate on cyclodehydration of **1a** to **2a** (residence time = 1.7 min).



Scheme 1 Optimised conditions for the flow synthesis of oxazolines.

Deoxo-Fluor® resulted in >99% conversion of the  $\beta$ -hydroxy amides to the oxazolines. The use of higher quantities of fluorinating agent led to a large number of unwanted by-products. Unlike typical batch reactions using Deoxo-Fluor®, which usually require cooling to  $-20$  °C,<sup>8</sup> it was found that in flow optimal yields were obtained at room temperature, desirably removing the need for cooling.

In a set of model experiments with amide **1a**, where residence time was kept constant at 1.7 min, greater conversion was observed as flow rate increased, suggesting that mixing was a key factor for this reaction (Fig. 2).

A flow rate of  $6$  mL min<sup>-1</sup> gave full conversion to the desired oxazoline **2a**.

Under these conditions, a solution of  $\beta$ -hydroxy amide (0.25 M) and a solution of Deoxo-Fluor®, each delivered at a flow rate of  $3.00$  mL min<sup>-1</sup>, were combined at a T-piece before passing into a reactor coil (1/16" o.d., 1 mm i.d., 10 mL, PFA) at  $25$  °C. The exiting stream was combined with an aqueous sodium bicarbonate solution at a T-mixer (flow rate of  $9$  mL min<sup>-1</sup>) to quench any residual HF and then directed into a Zaiput liquid-liquid membrane separator.<sup>22,23</sup> This device enabled separation of the two phases at a high combined flow rate ( $15$  mL min<sup>-1</sup>), with minimal breakthrough of the aqueous phase into the organic phase (Scheme 1).

The optimised conditions were successfully applied on a 2 mmol scale to a selection of  $\beta$ -hydroxy amides to obtain the desired oxazolines in moderate to excellent yields with no need for further purification (Table 1). Aryl oxazolines **2a-f**

were obtained in excellent yields and diastereoselectivities. The dipeptide derivatives subjected to these conditions (**1g**, **1h** and **1i**) showed excellent reactivities, yielding 92–98% of the desired oxazolines. Moreover, dicyclisation processes were possible (**2k** and **2l**) with good yield, although higher flow rates ( $10$  mL min<sup>-1</sup>) were required. It was found that the yields under flow conditions were typically 10% higher than the corresponding batch system, with the efficient heat transfer and rapid mixing greatly improving the safety profile when compared to the batch reaction.<sup>8</sup>

Such a dependence on the flow rate suggested that the mixing efficiency was a significant factor affecting the rate of cyclisation. Microfluidics are known to provide a highly efficient static mixing<sup>23–26</sup> and therefore the cyclodehydration of  $\beta$ -hydroxy amides **1b** and **1i** was attempted on a  $1$   $\mu$ L (Labtrix Start) microchip (Scheme 2).<sup>27</sup> It was found that both substrates could be cyclodehydrated in excellent yield at room temperature with residence times around 1 s, further supporting the importance of mixing for this process.<sup>28</sup>

Additionally, we wanted to investigate whether this flow protocol could be run continuously to afford larger amounts of material, which is frequently a requirement in synthesis. A microchip reactor would not be appropriate because whilst it generates an improved reaction rate, it cannot provide the same potential throughput as a mesofluidic system. Preliminary investigations into this were carried out using 30 g of  $\beta$ -hydroxy amide **1a**. A magnetic mixer was introduced to ensure complete quenching over an extended period as without this device, residual HF was observed in the organic stream. We also took the opportunity to test a simple large-scale gravity separation device (see SI) to recover the organic phase. Using this specific system,  $10.2$  g h<sup>-1</sup> of **2a** could be generated in a single continuous run over 2 h and 40 min, with 27.2 g of **2a** being produced (98% yield) (Scheme 3).

With flow conditions established for the cyclodehydration, we turned our attention to the MnO<sub>2</sub>-mediated oxidative aromatisation reaction, using oxazoline **2a** as a model substrate. Previous studies had demonstrated that the solvent and temperature have a strong influence on the general oxidative reactivity of MnO<sub>2</sub>.<sup>29–31</sup> Oxazoline **2a** (0.5 mmol) in 8 mL of a range of solvents was passed through a column reactor packed with activated MnO<sub>2</sub><sup>32</sup> (3 g) with an initial flow rate of  $100$   $\mu$ L min<sup>-1</sup>, which was reduced to  $60$   $\mu$ L min<sup>-1</sup> after 50 min. The flow output was directly collected and evaporated (Scheme 4). Dichloromethane, trifluorotoluene and isopropyl acetate afforded pure desired product at  $40$  °C, although in low isolated yield (40%, 20% and 32% respectively). We speculate that the remaining material has decomposed and is retained in the MnO<sub>2</sub> column. When isopropyl acetate was used as solvent at lower temperature ( $0$  °C), although less material was lost, the conversion was poorer and the yield significantly reduced (31%). Neither acetone or dimethoxy ethane (DME) afforded full conversion at  $40$  °C, but after purification afforded higher yields of the desired product (59% and 63% respectively). Pleasingly, it was found that by increasing the reaction temp-



Table 1 Flow cyclodehydration of  $\beta$ -hydroxy amides using Deoxo-Fluor®

Entry <sup>a</sup>	Substrate	Product	Isolated yield <sup>b</sup>
1			98%
2			98%
3			79% <sup>c</sup>
4			98%
5			99%
6			95%
7			98%
8			92%
9			95%
10			60%
11			85% <sup>d</sup>
12			92% <sup>d</sup>

<sup>a</sup> Reactions were run on a 2 mmol scale. <sup>b</sup> Compounds were isolated without purification. <sup>c</sup> The crude material was passed through a plug of calcium carbonate/silica in place of an aqueous work up. <sup>d</sup> Total flow rate = 10 mL min<sup>-1</sup> with 2.6 eq. of Deoxo-Fluor®.

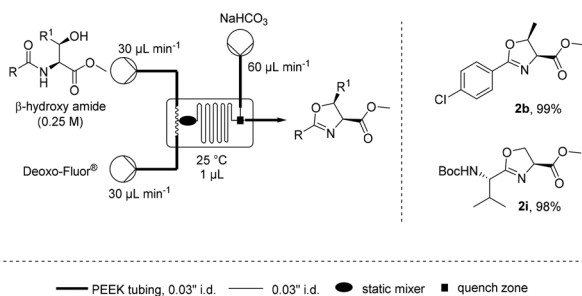

Scheme 2 Microchip reaction for the preparation of oxazolines.

erature to 60 °C with DME as solvent, pure **3a** could be isolated in 79% by simply removing the solvent *in vacuo* (Table 2).

Under these optimised conditions we were able to process several 2-aryl-substituted oxazolines to oxazoles with isolated yields of 50–79% (Scheme 4). Notably, pyridyl (**3c**) and styryl (**3d**) oxazolines were compatible with the process giving 65%

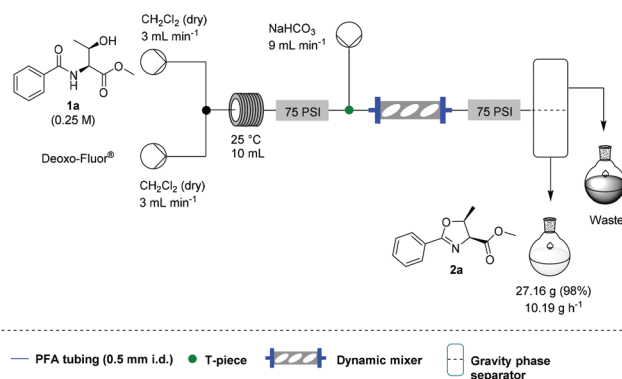

Scheme 3 Platform set up for the scale up experiment.

and 50% yields respectively. The mild reaction conditions allowed oxidation in the presence of an acid labile protecting group (**3e**). Desirably, all these oxazoles were obtained in

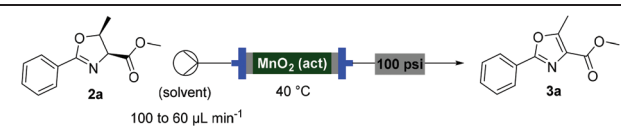

Table 2 Solvent screening for flow MnO<sub>2</sub> oxidation

Entry	Solvent	Temperature	Isolated yield
1	Acetone	40 °C	59% <sup>a</sup>
2	Dichloromethane	40 °C	40%
3	Trifluorotoluene	40 °C	20%
4	Isopropyl acetate	0 °C	31% <sup>a</sup>
5	Isopropyl acetate	40 °C	52%
6	Dimethoxyethane	40 °C	64% <sup>a</sup>
7	Dimethoxyethane	60 °C	79%

<sup>a</sup> Incomplete conversion so required purification.

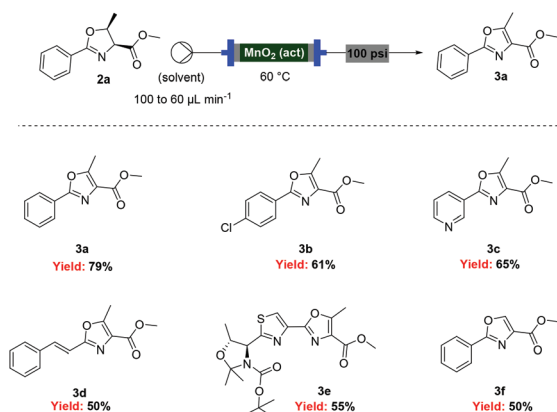
Scheme 4 Flow oxidation of aryl-oxazolines using activated MnO<sub>2</sub>.

analytically pure form without any further purification, with inductively coupled plasma-mass spectrometry (ICP-MS) analyses showing negligible leaching of MnO<sub>2</sub> (less than 10 ppb).

However, when these optimised conditions were applied to 2-alkyl-substituted oxazolines, extensive decomposition of these substrates to unidentified by-products was observed. It was suspected that the high reactivity of activated MnO<sub>2</sub> could be responsible for this decomposition, so the reaction was attempted using the less active amorphous MnO<sub>2</sub><sup>33</sup> under otherwise identical conditions. At 60 °C only partial conversion to the desired oxazoles was detected whereas increasing the temperature at 100 °C led to complete conversion of the starting material. This allowed access to a range of alkyl substituted oxazoles in moderate to good yields (Scheme 5), including sensitive substrates such as oxetane containing 3j. Notably, the double oxidation of 4 could be carried out in 83% yield to afford 5, an intermediate in our recent total synthesis of plantazolicin A and B.<sup>34</sup> When the same reaction was attempted in batch the yield could not be optimised beyond 20%, necessitating a stepwise synthesis of 5.

When using a flow system, there is the possibility to take advantage of the ability to perform reactions and processes under computer control.<sup>35</sup> In this case, the addition of an auto-

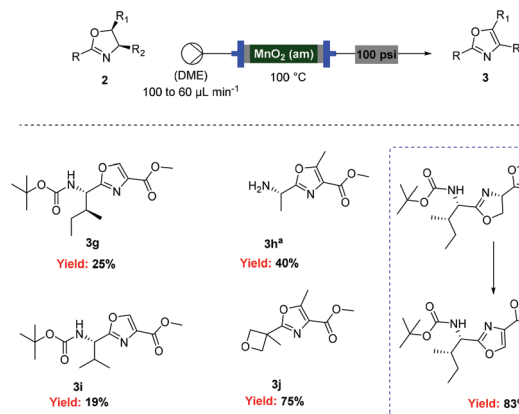
Scheme 5 Flow oxidation of 2-alkyl-oxazolines using amorphous MnO<sub>2</sub>.<sup>a</sup> Deprotection was observed.

mation layer enabled up to four reactions using different substrates to be performed in sequence, with no manual intervention required apart from loading the reagents before starting the procedure. A reactor configuration (Scheme 6) was devised that incorporated a multi-port switching valve (V1) such that four separate substrates could be passed through four separate columns to prevent any cross-contamination between samples. A secondary valve (V2) enabled the flow stream to be thoroughly purged between each sample, and prevented cross-contamination as V1 moved between the different positions. The pre-prepared reagent solutions were drawn from four separate bottles (selected by V1) and passed through the heated MnO<sub>2</sub> columns (1–4). A software protocol created in the Python programming language<sup>35,36</sup> and running on a Raspberry Pi® microcomputer<sup>37</sup> controlled the individual reactor components according to a pre-programmed sequence of timed actions, to coordinate the pumps and valves to perform the reactions. Using this system, a batch of four substrates was processed overnight (12 h). This demonstrates the ability for automated machine-assisted systems to save skilled researcher time in the laboratory.

## Conclusions

In conclusion, an improved rapid method for the flow synthesis of oxazolines at room temperature has been developed. A multi-hour continuous flow run illustrates the potential of this method for the safe large scale production of oxazolines. It was found that aryl-substituted oxazolines undergo smooth oxidative aromatisation when simply flowed through a column of activated MnO<sub>2</sub> at 60 °C, with isolated yields between 50–79%. Advantageously, unlike batch protocols, no downstream workup or purification was found to be required. The oxidation step has also been demonstrated to be amenable to automation which allows the sequential processing of 4 different substrates on a single flow platform, with minimal operator intervention. For the more sensitive 2-alkyl-substituted oxazolines, it was found that good results could be achieved using amorphous manganese dioxide at increased temperature, increasing the scope of this process.



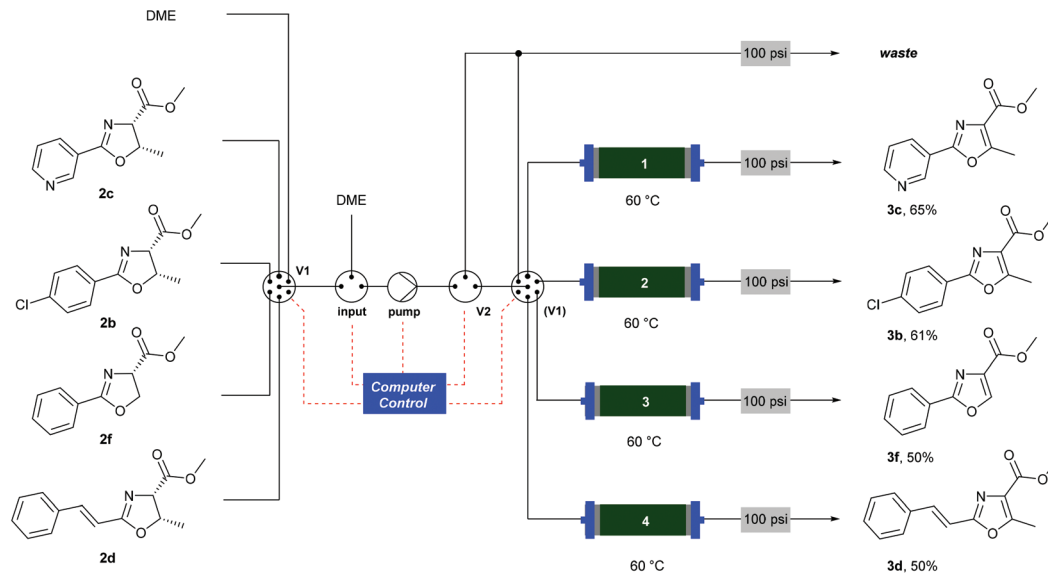

Scheme 6 Automated oxidation of oxazolines using a Raspberry Pi® computer and a multiple position valve.

## Experimental section

### General experimental section

$^1\text{H-NMR}$  spectra were recorded on a Bruker Avance DPX-400 spectrometer with the residual solvent peak as the internal reference ( $\text{CDCl}_3 = 7.26$  ppm,  $\text{d}_6\text{-DMSO} = 2.50$  ppm).  $^1\text{H}$  resonances are reported to the nearest 0.01 ppm.  $^{13}\text{C-NMR}$  spectra were recorded on the same spectrometers with the central resonance of the solvent peak as the internal reference ( $\text{CDCl}_3 = 77.16$  ppm,  $\text{d}_6\text{-DMSO} = 39.52$  ppm). All  $^{13}\text{C}$  resonances are reported to the nearest 0.1 ppm. DEPT 135, COSY, HMQC, and HMBC experiments were used to aid structural determination and spectral assignment. The multiplicity of  $^1\text{H}$  signals are indicated as: s = singlet, d = doublet, t = triplet, m = multiplet, br. = broad, or combinations of thereof. Coupling constants ( $J$ ) are quoted in Hz and reported to the nearest 0.1 Hz. Where appropriate, averages of the signals from peaks displaying multiplicity were used to calculate the value of the coupling constant. Infrared spectra were recorded neat on a Perkin-Elmer Spectrum One FT-IR spectrometer using Universal ATR sampling accessories. Unless stated otherwise, reagents were obtained from commercial sources and used without purification. The removal of solvent under reduced pressure was carried out on a standard rotary evaporator. Melting points were performed on either a Stanford Research Systems MPA100 (OptiMelt) automated melting point system and are uncorrected. High resolution mass spectrometry (HRMS) was performed using a Waters Micromass LCT Premier™ spectrometer using time of flight with positive ESI, or conducted by Mr Paul Skelton on a Bruker BioApex 47e FTICR spectrometer using (positive or negative) ESI or EI at 70 eV to within a tolerance of 5 ppm of the theoretically calculated value. LC-MS analysis was performed on an Agilent HP 1100 series chromatography (Mercury Luna 3u C18 (2) column) attached to a Waters ZQ2000 mass spectrometer with ESCi ionization

source in ESI mode. Elution was carried out at a flow rate of  $0.6\text{ mL min}^{-1}$  using a reverse phase gradient of acetonitrile and water containing 0.1% formic acid. Retention time ( $R_t$ ) is given in min to the nearest 0.1 min and the  $m/z$  value is reported to the nearest mass unit (m.u.). Specific optical rotation was recorded on a Perkin-Elmer Model 343 digital polarimeter, using a Na/Hal lamp set at 589 nm and with a path length of 100 mm. All  $[\alpha]_D$  values were measured using spectroscopy grade solvent at the specified concentration and temperature. Unless otherwise specified all the flow reactions were performed using a Vapourtec R2/R4+ flow platform.<sup>38</sup>

### General protocol for the preparation of oxazoline in flow

A solution of Deoxo-Fluor® (1 mL, 50% in toluene) in  $\text{CH}_2\text{Cl}_2$  (7.0 mL) and a solution of  $\beta$ -hydroxy amide (2 mmol) in  $\text{CH}_2\text{Cl}_2$  (8 mL) were combined at a T-piece (each stream run at  $3.0\text{ mL min}^{-1}$ ) and reacted at rt in a 10 mL PFA reactor coil. The combined stream was then directed to an aqueous quenching stream ( $9\text{ mL min}^{-1}$ ) and the solution directed to a liquid/liquid separator.<sup>22</sup>

**(4*S*,5*S*)-5-Methyl-2-phenyl-4,5-dihydro-oxazole-4-carboxylic acid methyl ester (2a).**  $^1\text{H-NMR}$  (600 MHz,  $\text{CDCl}_3$ )  $\delta = 7.98\text{--}7.96$  (m, 2H), 7.49–7.46 (m, 1H), 7.40–7.38 (m, 2H), 5.05 (dq, 1H,  $J = 10.2, 6.4$  Hz), 4.97 (d, 1H,  $J = 10.2$  Hz), 3.76 (s, 3H), 1.37 (d, 3H,  $J = 6.5$  Hz);  $^{13}\text{C-NMR}$  (151 MHz,  $\text{CDCl}_3$ )  $\delta = 170.5, 166.2, 131.9, 128.6, 128.4, 127.3, 77.7, 71.8, 52.2, 16.3$ ; **HR-MS** (ESI+) for  $\text{C}_{12}\text{H}_{14}\text{NO}_3^+ [\text{M} + \text{H}]^+$  calc.: 220.0974, found: 220.0981; **FT-IR** neat,  $\tilde{\nu}$  ( $\text{cm}^{-1}$ ) = 2953, 1736, 1645, 1603, 1580, 1496, 1450, 1384, 1349, 1244, 1197, 1174, 1067, 1045, 1001, 973, 934, 904, 886, 851, 778, 695; **specific rotation:**  $[\alpha]_D^{24.1} = +58.58^\circ\text{ cm}^3\text{ g}^{-1}\text{ dm}^{-1}$  ( $c = 8.5$  in ethanol). **Lit.:**  $[\alpha]_D^{20} = +69.4^\circ\text{ cm}^3\text{ g}^{-1}\text{ dm}^{-1}$  ( $c = 8.5$  in EtOH).<sup>39</sup>

**(4*S*,5*S*)-2-(4-Chlorophenyl)-5-methyl-4,5-dihydrooxazole-4-carboxylic acid methyl ester (2b).**  $^1\text{H-NMR}$  (600 MHz,  $\text{CDCl}_3$ )  $\delta =$



7.90 (d, 2H,  $J = 8.3$  Hz), 7.37 (d, 2H,  $J = 8.4$  Hz), 5.05 (m, 1H), 4.96 (d, 1H,  $J = 10.2$  Hz), 3.76 (s, 3H), 1.36 (d, 3H,  $J = 6.5$  Hz);  $^{13}\text{C-NMR}$  (151 MHz,  $\text{CDCl}_3$ )  $\delta = 170.3, 165.4, 138.1, 130.0, 128.7, 125.8, 78.0, 71.8, 52.2, 16.3$ ; **HR-MS** (ESI+) for  $\text{C}_{12}\text{H}_{13}\text{ClNO}_3^+ [\text{M} + \text{H}]^+$  calc.: 254.0584, found: 254.0575; **FT-IR** neat,  $\tilde{\nu}$  ( $\text{cm}^{-1}$ ) = 2953, 1737, 1646, 1599, 1491, 1437, 1404, 1384, 1355, 1244, 1197, 1172, 1091, 1075, 1045, 1015, 935, 904, 887, 840, 780, 731, 680; **specific rotation**:  $[\alpha]_{\text{D}}^{24.0} = +48.2^\circ \text{ cm}^3 \text{ g}^{-1} \text{ dm}^{-1}$  ( $c = 1$  in  $\text{CHCl}_3$ ).

**(4S,5S)-5-Methyl-2-(pyridin-3-yl)-4,5-dihydrooxazole-4-carboxylic acid methyl ester (2c)**.  $^1\text{H-NMR}$  (600 MHz,  $\text{CDCl}_3$ )  $\delta = 9.14\text{--}9.13$  (m, 1H), 8.69 (dd, 1H,  $J = 4.9, 1.7$  Hz), 8.24–8.22 (m, 1H), 7.33 (ddd, 1H,  $J = 7.9, 4.9, 0.8$  Hz), 5.07 (dq, 1H,  $J = 10.2, 6.5$  Hz), 4.97 (d, 1H,  $J = 10.2$  Hz), 3.75 (s, 3H), 1.37 (d, 3H,  $J = 6.5$  Hz);  $^{13}\text{C-NMR}$  (151 MHz,  $\text{CDCl}_3$ )  $\delta = 170.1, 164.3, 152.5, 149.8, 136.0, 123.5, 123.3, 78.1, 71.7, 52.3, 16.3$ ; **HR-MS** (ESI+) for  $\text{C}_{11}\text{H}_{13}\text{N}_2\text{O}_3^+ [\text{M} + \text{H}]^+$  calc.: 221.0926, found: 221.0926; **FT-IR** neat,  $\tilde{\nu}$  ( $\text{cm}^{-1}$ ) = 2953, 1743, 1650, 1593, 1432, 1417, 1353, 1246, 1198, 1176, 1082, 1044, 1023, 936, 905, 886, 821, 781, 708, 620; **specific rotation**:  $[\alpha]_{\text{D}}^{24.0} = +53.0^\circ \text{ cm}^3 \text{ g}^{-1} \text{ dm}^{-1}$  ( $c = 1$  in  $\text{CHCl}_3$ ).

**(4S,5S)-5-Methyl-2-((E)-styryl)-4,5-dihydrooxazole-4-carboxylic acid methyl ester (2d)**.  $^1\text{H-NMR}$  (600 MHz,  $\text{CDCl}_3$ )  $\delta = 7.43$  (d, 2H,  $J = 7.5$  Hz), 7.38 (d, 1H,  $J = 16.3$  Hz), 7.32–7.27 (m, 3H), 6.65 (d, 1H,  $J = 16.3$  Hz), 4.92 (dq, 1H,  $J = 10.1, 6.3$  Hz), 4.87 (d, 1H,  $J = 10.0$  Hz), 3.70 (s, 3H), 1.30 (d, 3H,  $J = 6.5$  Hz);  $^{13}\text{C-NMR}$  (151 MHz,  $\text{CDCl}_3$ )  $\delta = 170.0, 165.6, 140.8, 134.7, 129.5, 128.6, 127.3, 114.6, 77.1, 71.3, 51.8, 16.0$ ; **HR-MS** (ESI+) for  $\text{C}_{14}\text{H}_{16}\text{NO}_3^+ [\text{M} + \text{H}]^+$  calc.: 264.1236, found: 264.1227; **FT-IR** neat,  $\tilde{\nu}$  ( $\text{cm}^{-1}$ ) = 2951, 1735, 1652, 1607, 1496, 1449, 1358, 1242, 1197, 1174, 1045, 972, 948, 930, 840, 758, 732, 692; **specific rotation**:  $[\alpha]_{\text{D}}^{24.0} = +27.9^\circ \text{ cm}^3 \text{ g}^{-1} \text{ dm}^{-1}$  ( $c = 1$  in  $\text{CHCl}_3$ ).

**(4S,5S)-2-2-((4S,5R)-3-(tert-Butoxycarbonyl)-2,2,5-trimethyl-oxazolidin-4-yl)thiazol-4-yl)-5-methyl-4,5-dihydrooxazole-4-carboxylic acid methyl ester (2e)**.  $^1\text{H-NMR}$  (400 MHz,  $\text{CDCl}_3$ )  $\delta = 8.03$  (s, 1H), 5.10–5.05 (m, 1H), 4.99 (s, 1H), 4.87–4.74 (s, 1H), 4.25–4.14 (m, 1H), 3.76 (s, 3H), 1.69 (s, 6H), 1.43 (s, 9H), 1.20 (s, 6H);  $^{13}\text{C-NMR}$  (100 MHz,  $\text{CDCl}_3$ )  $\delta = 173.9, 170.1, 161.5, 151.5, 143.4, 124.2, 95.37, 80.9, 78.5, 78.0, 71.8, 66.0, 52.2, 28.2, 26.6, 26.1, 18.1, 16.2$ . **HR-MS** (ESI+) for  $\text{C}_{20}\text{H}_{30}\text{N}_3\text{O}_6\text{S}^+ (\text{M} + \text{H})^+$  calc.: 440.1855, found: 440.1844. **FT-IR** neat,  $\tilde{\nu}$  ( $\text{cm}^{-1}$ ) = 2977, 1753, 1740, 1704, 1649, 1538, 1453, 1361, 1337, 1303, 1261, 1213, 1177, 1132, 1088, 1066, 1047, 982, 957, 918, 897, 878, 855, 835, 776, 755, 725; **specific rotation**:  $[\alpha]_{\text{D}}^{23.9} = -7.4^\circ \text{ cm}^3 \text{ g}^{-1} \text{ dm}^{-1}$  ( $c = 1$  in  $\text{CHCl}_3$ ).

**(S)-2-Phenyl-4,5-dihydrooxazole-4-carboxylic acid methyl ester (2f)**.  $^1\text{H-NMR}$  (400 MHz,  $\text{CDCl}_3$ )  $\delta = 7.98$  (d, 2H,  $J = 7.5$  Hz), 7.49 (m, 1H), 7.41 (m, 2H), 4.97 (m, 1H), 4.69 (m, 1H), 4.58 (m, 1H), 3.82 (s, 3H) ppm. Data match those reported in: A. I. Meyers and F. X. Tavares, *J. Org. Chem.*, 1996, **61**, 8207–8215.

**(S)-2-((1S,2S)-1-((tert-Butoxycarbonyl)amino)-2-methylbutyl)-4,5-dihydrooxazole-4-carboxylic acid methyl ester (2g)**.  $^1\text{H-NMR}$  (400 MHz,  $\text{CDCl}_3$ )  $\delta = 5.20$  (d, 1H,  $J = 9.0$  Hz), 4.75 (m, 1H), 4.52 (t, 1H,  $J = 8.5$  Hz), 4.45 (dd, 1H,  $J = 10.5, 9.4$  Hz), 4.39

(dd, 1H,  $J = 8.6, 4.4$  Hz), 3.77 (s, 3H), 1.84 (s, 1H), 1.50 (m, 1H), 1.43 (s, 9H), 1.15 (m, 1H), 0.89–0.94 (m, 6H) ppm. Data match those reported in: S. Peña, L. Scarone, E. Manta, L. Stewart, V. Yardley, S. Croft and G. Serra, *Bioorg. Med. Chem. Lett.*, 2012, **12**, 4994–4997.

**(S)-2-((S)-1-((tert-Butoxycarbonyl)amino)ethyl)-4,5-dihydrooxazole-4-carboxylic acid methyl ester (2h)**.  $^1\text{H-NMR}$  (400 MHz,  $\text{CDCl}_3$ )  $\delta = 5.30$  (1H, s), 4.95 (m, 1H), 4.79 (dd, 1H,  $J = 10.0, 1.5$  Hz), 4.44 (m, 1H), 3.76 (s, 3H), 1.50–1.40 (m, 10H), 1.28 (d, 3H,  $J = 6.5$  Hz) ppm. Data match those reported in: Z. Xia and C. D. Smith, *J. Org. Chem.*, 2001, **66**, 3459–3466.

**(S)-2-((S)-1-((tert-Butoxycarbonyl)amino)-2-methylpropyl)-4,5-dihydrooxazole-4-carboxylic acid methyl ester (2i)**.  $^1\text{H-NMR}$  (400 MHz,  $\text{CDCl}_3$ )  $\delta = 5.18$  (d, 1H,  $J = 8.9$  Hz), 4.74 (m, 1H), 4.51 (t, 1H,  $J = 8.7$  Hz), 4.43 (dd, 1H,  $J = 10.3, 8.7$  Hz), 4.33 (dd, 1H,  $J = 8.7, 4.0$  Hz), 3.70 (s, 3H), 2.10 (m, 1H), 1.43 (s, 9H), 0.95 (d, 3H,  $J = 7.0$  Hz), 0.90 (d, 3H,  $J = 6.8$  Hz) ppm. Data match those reported in: A. I. Meyers and F. X. Tavares, *J. Org. Chem.*, 1996, **61**, 8207–8215.

**(4S,5S)-5-Methyl-2-(3-methyloxetan-3-yl)-4,5-dihydrooxazole-4-carboxylic acid methyl ester (2j)**.  $^1\text{H-NMR}$  (600 MHz,  $\text{CDCl}_3$ )  $\delta = 4.99$  (d, 1H,  $J = 5.8$  Hz), 4.98–4.93 (m, 1H), 4.95 (d, 1H,  $J = 5.8$  Hz), 4.82 (d, 1H,  $J = 10.1$  Hz), 4.45 (d, 1H,  $J = 5.8$  Hz), 4.44 (d, 1H,  $J = 5.8$  Hz), 3.76 (s, 3H), 1.66 (s, 3H), 1.30 (d, 3H,  $J = 6.5$  Hz);  $^{13}\text{C-NMR}$  (151 MHz,  $\text{CDCl}_3$ )  $\delta = 172.1, 170.2, 80.1, 80.0, 78.3, 71.5, 52.3, 39.6, 22.3, 16.2$ ; **HR-MS** (ESI+) for  $\text{C}_{10}\text{H}_{16}\text{NO}_4^+ [\text{M} + \text{H}]^+$  calc.: 214.1079, found: 214.1076; **FT-IR** neat,  $\tilde{\nu}$  ( $\text{cm}^{-1}$ ) = 2926, 1738, 1658, 1450, 1361, 1255, 1198, 1175, 1133, 1044, 982, 945, 844, 781, 732; **specific rotation**:  $[\alpha]_{\text{D}}^{23.9} = +47.2^\circ \text{ cm}^3 \text{ g}^{-1} \text{ dm}^{-1}$  ( $c = 1$  in  $\text{CHCl}_3$ ).

**(4R,4'S,5S,5'S)-2'-((1S,2S)-1-((tert-Butoxycarbonyl)amino)-2-methylbutyl)-5,5'-dimethyl-4,4',5,5'-tetrahydro-[2,4'-bioxazole]-4-carboxylic methyl ester (2k)**.  $^1\text{H-NMR}$  (600 MHz,  $\text{CDCl}_3$ )  $\delta = 7.58$  (s, 1H), 6.57–6.39 (m, 1H), 5.14 (d,  $J = 7.5$  Hz, 1H), 4.92 (s, 1H), 4.77 (d,  $J = 10.0$  Hz, 1H), 4.08 (d,  $J = 7.1$  Hz, 1H), 3.70 (s, 3H), 1.92 (s, 1H), 1.72 (d,  $J = 7.2$  Hz, 3H), 1.52 (d,  $J = 17.1$  Hz, 1H), 1.45–1.36 (m, 21H), 1.25 (d,  $J = 6.5$  Hz, 3H), 1.13 (d,  $J = 20.7$  Hz, 1H), 0.95 (d,  $J = 6.9$  Hz, 3H), 0.87 (t,  $J = 7.4$  Hz, 4H);  $^{13}\text{C-NMR}$  (151 MHz,  $\text{CDCl}_3$ )  $\delta = 170.0, 169.8, 164.2, 155.7, 130.8, 122.8, 79.8, 78.3, 71.2, 59.5, 51.9, 37.3, 28.2, 24.6, 16.0, 15.7, 14.8, 11.5$ ; **HR-MS** (ESI+) for  $\text{C}_{20}\text{H}_{34}\text{N}_3\text{O}_6^+ (\text{M} + \text{H})^+$  calc.: 412.2448, found.: 412.2442; **FT-IR** neat,  $\tilde{\nu}$  ( $\text{cm}^{-1}$ ) = 3342, 3256, 2967, 1740, 1687, 1658, 1626, 1521, 1454, 1390, 1365, 1288, 1240, 1200, 1170, 1042, 1019, 870, 777; **specific rotation**:  $[\alpha]_{\text{D}}^{26.0} = +19.7^\circ \text{ cm}^3 \text{ g}^{-1} \text{ dm}^{-1}$  ( $c = 1$  in  $\text{CHCl}_3$ ).

**2,6-Bis((R)-4-Phenyl-4,5-dihydrooxazol-2-yl)pyridine (2l)**.  $^1\text{H-NMR}$  (400 MHz,  $\text{CDCl}_3$ )  $\delta = 8.36$  (d, 2H,  $J = 7.8$  Hz), 7.93 (t, 1H,  $J = 7.8$  Hz), 7.40–7.29 (m, 10H), 5.48 (dd, 2H,  $J = 10.2, 8.7$  Hz), 4.94 (dd, 2H,  $J = 8.7, 10.4$  Hz), 4.44 (t, 2H,  $J = 8.9$  Hz) ppm. Data match those reported in: P. C. Knipea and M. D. Smith, *Org. Biomol. Chem.*, 2014, **12**, 5094–5097.

#### General protocol for the preparation of 2-aryl-oxazoles in flow

A solution of oxazoline (0.5 mmol) in DME (8 mL) was passed through a column reactor packed with activated  $\text{MnO}_2$  at 60 °C (flow rate 100  $\mu\text{L min}^{-1}$  for 50 min then 60  $\mu\text{L min}^{-1}$ ). The



machine output was collected and concentrated under vacuum to give the corresponding oxazoles in good yield, without the need of further purification.

**2-Phenyl-5-methyloxazole-4-carboxylic acid methyl ester (3a).**  $^1\text{H-NMR}$  (400 MHz,  $\text{CDCl}_3$ )  $\delta$  = 8.03 (m, 2H), 7.42 (m, 3H), 3.91 (s, 3H), 2.68 (s, 3H) ppm. Data matched those reported in: G. Yuan, Z. Zhu, X. Gao and H. Jiang, *RSC Adv.*, 2014, 4, 24300–24303.

**2-(4-Chlorophenyl)-5-methyloxazole-4-carboxylic acid methyl ester (3b).** White solid, m.p. 102–104 °C;  $^1\text{H-NMR}$  (400 MHz,  $\text{CDCl}_3$ )  $\delta$  = ppm 7.99–8.02 (m, 2H), 7.42–7.45 (m, 2H), 3.95 (s, 3H), 2.71 (s, 3H);  $^{13}\text{C-NMR}$  (126 MHz,  $\text{CDCl}_3$ )  $\delta$  = 162.7, 158.8, 156.6, 137.0, 129.1, 128.7, 127.8, 125.0, 52.1, 12.1 ppm; **HR-MS** (ESI+) for  $\text{C}_{12}\text{H}_{11}\text{NClO}_3^+$   $[\text{M} + \text{H}]^+$  calc.: 252.0427, found: 252.0422; **FT-IR** neat,  $\tilde{\nu}$  ( $\text{cm}^{-1}$ ) = 3001, 2950, 2857, 1717, 1614, 1585, 1559, 1485, 1450, 1346, 1278, 1235, 1109, 1090, 1056, 1011, 827, 726, 692.

**5-Methyl-2-(pyridin-3-yl)oxazole-4-carboxylic acid methyl ester (3c).** Yellowish solid, m.p. 62–70 °C;  $^1\text{H-NMR}$  (400 MHz,  $\text{CDCl}_3$ )  $\delta$  = 9.27 (d, 1H,  $J$  = 1.5 Hz), 8.69 (dd, 1H,  $J$  = 4.8,  $J$  = 1.5 Hz), 8.35 (dt, 1H,  $J$  = 8.3,  $J$  = 1.9 Hz), 7.38–7.42 (m, 1H), 3.95 (s, 3H), 2.73 (s, 3H);  $^{13}\text{C-NMR}$  (126 MHz,  $\text{CDCl}_3$ )  $\delta$  = 162.5, 157.3, 151.4, 147.6, 133.8, 128.8, 127.8, 123.6, 122.9, 52.2, 12.1 ppm; **HR-MS** (ESI+) for  $\text{C}_{11}\text{H}_{11}\text{N}_2\text{O}_3^+$   $[\text{M} + \text{H}]^+$  calc.: 219.0770, found: 219.0779; **FT-IR**: neat,  $\tilde{\nu}$  ( $\text{cm}^{-1}$ ) = 3011, 2953, 1713, 1614, 1577, 1483, 1431, 1418, 1386, 1347, 1235, 1197, 1109, 1071, 1018, 979, 820, 783, 719, 703.

**(E)-5-Methyl-2-styryloxazole-4-carboxylic acid methyl ester (3d).** White solid, m.p. 86–88 °C;  $^1\text{H-NMR}$  (400 MHz,  $\text{CDCl}_3$ )  $\delta$  = 7.50–7.56 (m, 3H), 7.37–7.41 (m, 2H), 7.33–7.37 (m, 1H), 6.90 (d,  $J$  = 16.5 Hz), 3.93 (s, 3H), 2.68 ppm (s, 3H) ppm;  $^{13}\text{C-NMR}$  (126 MHz,  $\text{CDCl}_3$ )  $\delta$  = 162.7, 159.4, 156.1, 137.1, 135.2, 129.4, 128.9, 127.2, 113.1, 52.0, 12.1 ppm; **HR-MS** (ESI+) for  $\text{C}_{14}\text{H}_{14}\text{NO}_3^+$   $[\text{M} + \text{H}]^+$  calc.: 244.0968, found: 244.0961; **FT-IR** neat,  $\tilde{\nu}$  ( $\text{cm}^{-1}$ ) 2954, 1715, 1644, 1544, 1438, 1388, 1367, 1220, 1180, 1102, 988, 965, 757.

**2-(2-((4S,5R)-3-(tert-Butoxycarbonyl)-2,2,5-trimethyloxazolidin-4-yl)thiazol-4-yl)-5-methyloxazole-4-carboxylic acid methyl ester (3e).**  $^1\text{H-NMR}$  (400 MHz,  $\text{CDCl}_3$ )  $\delta$  = 8.11 (br. s., 1H), 4.82 (br. s., 1H), 4.21 (d, 1H,  $J$  = 6.3 Hz), 3.95 (s, 3H), 2.74 (s, 3H), 1.72 (br. s., 6H), 1.41–1.55 (m, 6H), 1.13–1.24 (m, 6H) ppm;  $^{13}\text{C}$  NMR (126 MHz,  $\text{CDCl}_3$ ) [*conformers*]  $\delta$  = 174.2, 170.1, 162.6, 156.6, 155.0, 142.3, 130.2, 129.2, 128.4, 120.4, 95.3, 80.8, 77.8, 66.0, 52.1, 28.1, 26.5, 25.9, 17.8, 12.2; **HRMS** (ESI+) for  $[\text{M} + \text{Na}]^+$   $\text{C}_{20}\text{H}_{27}\text{N}_3\text{O}_6\text{SNa}^+$  calc.: 460.1518; found: 460.1501; **FT-IR** neat,  $\tilde{\nu}$  ( $\text{cm}^{-1}$ ) 2977, 2364, 1706, 1616, 1443, 1365, 1262, 1175, 1106, 984, 855, 731.

**2-Phenyloxazole-4-carboxylic acid methyl ester (3f).**  $^1\text{H-NMR}$  (400 MHz,  $\text{CDCl}_3$ )  $\delta$  = 8.30 (s, 1H), 8.11–8.13 (m, 2H), 7.55–7.45 (m, 3H), 3.96 (s, 3H) ppm. Data match those reported in: A. I. Meyers and F. X. Tavares, *J. Org. Chem.*, 1996, 61, 8207–8215.

#### General protocol for the preparation of 2-alkyl-oxazoles in flow

A solution of oxazoline (0.125 mmol) in DME (2 mL) was loaded into a 2 mL loop and then passed through a column

reactor packed with activated  $\text{MnO}_2$  at 100 °C (flow rate 100  $\mu\text{L min}^{-1}$  for 50 min then 60  $\mu\text{L min}^{-1}$ ). Unless otherwise stated, the machine output was collected and concentrated under vacuum to give the corresponding oxazoles.

**2-((1S,2S)-1-((tert-Butoxycarbonyl)amino)-2-methylbutyl)oxazole-4-carboxylic acid methyl ester (3g).**  $^1\text{H-NMR}$  ( $\text{CDCl}_3$ , 400 MHz)  $\delta$  = 8.17 (s, 1H), 5.30 (d,  $J$  = 7.7 Hz, 1H), 4.89–4.80 (m, 1H), 3.90 (s, 3H), 2.00–1.87 (m, 1H), 1.51–1.31 (m, 10H), 1.17 (m, 1H), 0.90–0.85 (m, 6H);  $^{13}\text{C-NMR}$  ( $\text{CDCl}_3$ , 100 MHz):  $\delta$  = 165.1, 161.6, 155.2, 143.7, 133.2, 80.0, 53.3, 52.2, 39.5, 28.3, 25.0, 15.1, 11.3; **HRMS** (ESI+) for  $[\text{M} + \text{H}]^+$   $\text{C}_{15}\text{H}_{25}\text{N}_2\text{O}_5$  calculated 313.1758, found 313.1750; **FT-IR** neat,  $\tilde{\nu}$  ( $\text{cm}^{-1}$ ) 3323, 2972, 1728, 1698, 1530, 1328, 1232, 1152, 1105; **specific rotation**:  $[\alpha]_{\text{D}}^{28.3} = -26.2 \text{ cm}^3 \text{ g}^{-1} \text{ dm}^{-1}$  ( $c$  = 1 in  $\text{CHCl}_3$ ).

**(S)-2-(1-Aminoethyl)-5-methyloxazole-4-carboxylic acid methyl ester (3h).**  $^1\text{H-NMR}$  (400 MHz,  $\text{CDCl}_3$ )  $\delta$  = 5.02 (q, 1H,  $J$  = 6.2 Hz), 3.91 (s, 3H), 2.68 (s, 3H), 1.36 (d, 3H,  $J$  = 6.3 Hz) ppm. Data match those reported in: A. I. Meyers and F. X. Tavares, *J. Org. Chem.*, 1996, 61, 8207–8215.

**(S)-2-(1-((tert-Butoxycarbonyl)amino)-2-methylpropyl)oxazole-4-carboxylic acid methyl ester (3i).**  $^1\text{H-NMR}$  (400 MHz,  $\text{CDCl}_3$ )  $\delta$  = 5.28 (d, 1H,  $J$  = 8.8 Hz), 4.80 (dd, 1H,  $J$  = 8.8, 6.2 Hz), 3.92 (s, 3H), 2.19 (m, 1H), 1.43 (s, 9H), 0.93 (d, 3H,  $J$  = 7.0 Hz), 0.91 (d, 3H,  $J$  = 6.8 Hz) ppm. Data matched those reported in: A. Bertram and G. Pattenden, *Heterocycles*, 2002, 58, 521–561.

**5-Methyl-2-(3-methyloxetan-3-yl)oxazole-4-carboxylic acid methyl ester (3j).**  $^1\text{H-NMR}$  (400 MHz,  $\text{CDCl}_3$ )  $\delta$  = 5.06 (d, 2H,  $J$  = 5.9 Hz), 4.53 (d,  $J$  = 5.9 Hz, 2H), 3.89 (s, 3H), 2.62 (s, 3H), 1.79 (s, 3H) ppm;  $^{13}\text{C}$  NMR (100 MHz,  $\text{CDCl}_3$ )  $\delta$  164.0, 162.7, 156.7, 127.4, 80.5, 52.0, 39.6, 22.8, 12.0; **HR-MS** (ESI+) for  $\text{C}_{10}\text{H}_{14}\text{NO}_4^+$   $[\text{M} + \text{H}]^+$  calc.: 212.0917, found: 212.0913; **FT-IR** neat,  $\tilde{\nu}$  ( $\text{cm}^{-1}$ ) 2956, 2880, 1719, 1668, 1621, 1585, 1441, 1350, 1250, 1180, 1132, 1090, 980, 787.

**2'-((1S,2S)-1-((tert-Butoxycarbonyl)amino)-2-methylbutyl)-[2,4'-bioxazole]-4-carboxylic acid methyl ester (5).**  $^1\text{H-NMR}$  ( $\text{CDCl}_3$ , 400 MHz)  $\delta$  = 8.30 (s, 1H), 8.29 (s, 1H), 5.30 (d,  $J$  = 9.1 Hz, 1H), 4.90 (dd,  $J$  = 9.2, 5.8 Hz, 1H), 3.94 (s, 3H), 2.02–1.92 (m, 1H), 1.47–1.40 (m, 10H), 1.43 (m, 1H), 0.90–0.80 (m, 6H);  $^{13}\text{C-NMR}$  ( $\text{CDCl}_3$ , 100 MHz)  $\delta$  = 165.5, 161.3, 155.7, 155.2, 143.7, 139.3, 134.3, 129.6, 80.1, 53.4, 52.3, 39.5, 28.3, 25.1, 15.2, 11.4; **HRMS** (ESI) for  $\text{C}_{18}\text{H}_{25}\text{N}_3\text{O}_6\text{Na}^+$   $[\text{M} + \text{Na}]^+$  calculated: 402.1636; found: 402.1629; **FT-IR** neat,  $\tilde{\nu}$  ( $\text{cm}^{-1}$ ) 3141, 2959, 1721, 1690, 1509, 1247, 1147, 1001, 870, 729; **specific rotation**:  $[\alpha]_{\text{D}}^{25.0} = -34.0 \text{ cm}^3 \text{ g}^{-1} \text{ dm}^{-1}$  ( $c$  = 1 in  $\text{CHCl}_3$ ).

## Acknowledgements

We are grateful to the Swiss National Science Foundation (DNT), the Ralph Raphael fellowship (RJI), the German Academic Exchange Service DAAD (SF), the Royal Society Newton International Fellowship (ZEW), Pfizer Worldwide Research and Development (CB) and the EPSRC (SVL, SF and ZEW, grant n° EP/K0099494/1) for financial support. The Labtrix Start was kindly loaned by Chemtrix BV and the liquid-liquid



phase separator by Zaiput Flow Technologies (we are grateful to Dr Andrea Adamo for technical support with this device).

## Notes and references

- L. T. Tan, R. T. Williamson, W. H. Gerwick, K. S. Watts, K. McGough and R. Jacobs, *J. Org. Chem.*, 2000, **65**, 419–425.
- J. A. McIntosh, M. S. Donia and E. W. Schmidt, *Nat. Prod. Rep.*, 2009, **26**, 537–559.
- P. Wipf and C. P. Miller, *Tetrahedron Lett.*, 1992, 907–910.
- P. Wipf and C. P. Miller, *Tetrahedron Lett.*, 1992, **33**, 6267–6270.
- F. Yokokawa and T. Shioiri, *Tetrahedron Lett.*, 2002, **43**, 8679–8682.
- F. Yokokawa, Y. Hamada and T. Shioiri, *Synlett*, 1992, 153–155.
- A. I. Meyers and D. Hoyer, *Tetrahedron Lett.*, 1985, **26**, 4687–4690.
- A. J. Phillips, Y. Uto, P. Wipf, M. J. Reno and D. R. Williams, *Org. Lett.*, 2000, **2**, 1165–1168.
- M. Baumann, I. R. Baxendale, M. Brasholz, J. J. Hayward, S. V. Ley and N. Nikbin, *Synlett*, 2011, 1375–1380.
- D. W. Knight, G. Pattenden and D. E. Rippon, *Synlett*, 1990, 36–37.
- J. A. Lafontaine, D. P. Provencal, C. Gardelli and J. W. Leahy, *J. Org. Chem.*, 2003, **68**, 4215–4234.
- A. I. Meyers and F. Tavares, *Tetrahedron Lett.*, 1994, **35**, 2481–2484.
- Y. Huang, L. Ni, H. Gan, Y. He, J. Xu, X. Wu and H. Yao, *Tetrahedron*, 2011, **67**, 2066–2071.
- Y.-B. Yu, H.-L. Chen, L.-Y. Wang, X.-Z. Chen and B. Fu, *Molecules*, 2009, **14**, 4858–4865.
- K. Meguro, H. Tawada, Y. Sugiyama, T. Fujita and Y. Kawamatsu Awamatsu, *Chem. Pharm. Bull.*, 1986, **34**, 2840–2851.
- C. Shin, Y. Nakamura and K. Okumura, *Chem. Lett.*, 1993, 1405–1408.
- For information about Omnifit® glass columns, see: <http://www.omnifit.com/>.
- C. Battilocchio, J. M. Hawkins and S. V. Ley, *Org. Lett.*, 2014, **16**, 1060–1063.
- A. Fernández, Z. C. Levine, M. Baumann, S. Sulzer-Mossé, C. Sparr, S. Schläger, A. Metzger, I. R. Baxendale and S. V. Ley, *Synlett*, 2013, 514–518.
- C. Battilocchio, M. Baumann, I. R. Baxendale, M. Biava, M. O. Kitching, S. V. Ley, R. E. Martin, S. A. Ohnmacht and N. D. C. Tappin, *Synthesis*, 2012, 635–647.
- (a) Due to the approximate concentration of Deoxo-Fluor® solutions (≈50% in toluene) in commercial samples, we could only obtain reproducible results using 1.35 equiv. of reagent (b) Deoxo-Fluor® (≈50% in toluene) was purchased from Sigma Aldrich (94324-50ML-F) and used as supplied.
- (a) For information about the Zaiput liquid-liquid separator, see <https://www.zaiput.com>; for a description of the device, see also: (b) A. Adamo, P. L. Heider, N. Weeranoppanant and K. F. Jensen, *Ind. Eng. Chem. Res.*, 2013, **52**, 10802–10808; (c) T. A. Hamlin, G. M. L. Lazarus, C. B. Kelly and N. E. Leadbeater, *Org. Process Res. Dev.*, 2014, **18**, 1253–1258.
- J.-i. Yoshida, *Flash Chemistry: Fast Organic Synthesis in Microsystems*, Wiley-VCH, 2008.
- V. Hessel, H. Löwe and F. Schönfeld, *Chem. Eng. Sci.*, 2005, **60**, 2479–2501.
- A. D. Stroockl, S. K. W. Dertinger, A. Ajdari, I. Mezić, H. A. Stone and G. M. Whitesides, *Science*, 2002, **295**, 647–651.
- X. Fu, S. Liu, X. Ruan and H. Yang, *Sens. Actuators, B*, 2006, **114**, 618–624.
- For information about the Labtrix® Start system, see: <http://www.chemtrix.com>.
- For a recent review on mixing effect under flow conditions, see: R. L. Hartman, J. P. McMullen and K. F. Jensen, *Angew. Chem., Int. Ed.*, 2011, **50**, 7502–7519.
- R. J. Gritter, G. D. Dupre and T. J. Wallace, *Nature*, 1964, **202**, 179–181.
- A. J. Fatiadi, *Synthesis*, 1976, 65–104.
- R. J. K. Taylor, M. Reid, J. Foot and S. A. Raw, *Acc. Chem. Res.*, 2005, **38**, 851–869.
- Activated MnO<sub>2</sub> was purchased from Sigma-Aldrich (217646-100G) and used as supplied.
- Amorphous MnO<sub>2</sub> was purchased from Sigma-Aldrich (310700-500G) and used as supplied.
- Z. E. Wilson, S. Fenner and S. V. Ley, submitted manuscript.
- R. J. Ingham, C. Battilocchio, J. M. Hawkins and S. V. Ley, *Beilstein J. Org. Chem.*, 2014, **10**, 641–652.
- For information about the Python programming language, see: <http://www.python.org>.
- For information about the Raspberry Pi® microcomputer, see: <http://www.raspberrypi.org>.
- For information about the Vapourtec R2+/R4 reactor, see: <http://www.vapourtec.co.uk/>.
- H. Aït-Haddou, O. Hoarau, D. Cramailère, F. Pezet, J.-C. Daran and G. G. A. Balavoine, *Chem. – Eur. J.*, 2004, **10**, 699–707.

