



Cite this: *Org. Biomol. Chem.*, 2015, **13**, 4231

Flow synthesis of ethyl isocyanoacetate enabling the telescoped synthesis of 1,2,4-triazoles and pyrrolo-[1,2-*c*]pyrimidines†

Marcus Baumann,^a Antonio M. Rodriguez Garcia^{a,b} and Ian R. Baxendale*^a

The efficient flow synthesis of important heterocyclic building blocks based on the 1,2,4-triazole and pyrrolo[1,2-*c*]pyrimidine scaffold has been achieved. Crucially, a telescoped continuous flow process was developed based on the reaction of *N*-formylglycine with triphosgene to deliver a stream of ethyl isocyanoacetate *in situ*, which subsequently yielded the desired heterocyclic entities in a telescoped reaction. Additionally, the functionalisation of the pyrrolo[1,2-*c*]pyrimidine core *via* subsequent S_EAr reactions was studied revealing insight into a 'halogen dance' phenomenon associated with these medically relevant architectures.

Received 4th February 2015,
Accepted 26th February 2015

DOI: 10.1039/c5ob00245a

www.rsc.org/obc

Introduction

The efficient preparation of novel heterocyclic building blocks functionalised with suitable derivatisation sites is of paramount importance to the successful discovery of new bioactive molecules.¹ Certainly the most effective pharmaceutical and agrochemical strategy for the generation of propriety leads is through screening of diverse core structures, which upon strategic functionalisation engenders desirable physiological properties and yields focused libraries of advanced drug-like structures. Consequently, the conformational presentation displayed by the core template impacts strongly on the available binding and contact points that can be interacted upon within the biological environment. It is therefore not surprising that most of today's top-selling drugs contain at least one heterocyclic core often acting as its pharmacophore.² In order to efficiently access new chemical scaffolds medicinal chemists have been increasingly exploiting enabling technologies to allow access to novel chemical space.³ Amongst these technologies flow chemistry approaches have gained widespread acceptance as a powerful means to overcome limitations regarding scale-up, reproducibility, safety and accessible chemical space with numerous publications detailing the results of such studies.⁴

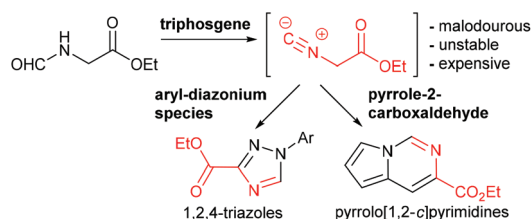

Scheme 1 Multi-step flow approach towards valuable heterocyclic scaffolds.

One particular area where flow chemistry has led to significantly improved safety profiles compared to traditional batch synthesis is the *in situ* generation and subsequent use of highly reactive, yet hazardous species. Examples include, but are not limited to, the generation and use of ozone,⁵ azides,⁶ diazonium species,⁷ or elemental fluorine⁸ as well as cryogenic⁹ or high temperature¹⁰ reactions.

In this paper we wish to disclose our latest results towards the flow synthesis of valuable heterocyclic architectures such as 1,2,4-triazoles and pyrrolo[1,2-*c*]pyrimidines based on the *in situ* generation of ethyl isocyanoacetate through the dehydration of *N*-formylglycine using reactive triphosgene (Scheme 1).

Results and discussion

Synthesis of ethyl isocyanoacetate in flow

Ethyl isocyanoacetate (**3**) is a commercially available high boiling liquid characterised by its pungent odour as well as its sensitivity towards light and moisture. Despite this it is fre-

^aDepartment of Chemistry, Durham University, South Road, Durham, DH1 3LE, UK.
E-mail: i.r.baxendale@durham.ac.uk

^bUniversidad de Castilla-La Mancha, Departamento de Química Orgánica, Facultad de Ciencias y Tecnologías Químicas, Avd. Camilo José Cela, 10, 13071 Ciudad Real, Spain

† Electronic supplementary information (ESI) available. CCDC 1039437, 1039438, 1039439, 1039440 and 1039441. For ESI and crystallographic data in CIF or other electronic format see DOI: 10.1039/c5ob00245a



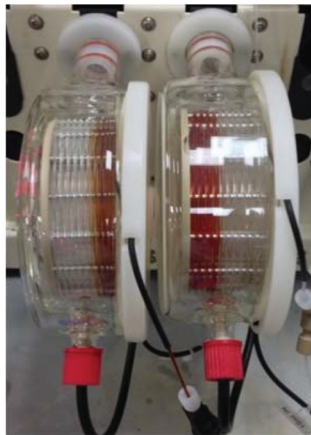
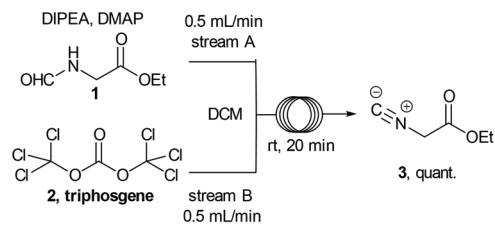

Scheme 2 Flow synthesis of ethyl isocyanoacetate (Reactor flow pathway left to right).

quently used as a key building block in multicomponent reactions and heterocycle synthesis.¹¹ Because of these features we decided to develop a convenient *in situ* flow synthesis of ethyl isocyanoacetate starting from readily available *N*-formylglycine (1).¹² As the dehydrating agent we choose triphosgene (2), a commercially available crystalline solid.¹³ This material is not only easier to handle than many other dehydrating agents (*e.g.* COCl_2 , POCl_3 , SOCl_2 *etc.*), but also comprises three equivalents of active dehydrating agent per molecule. Furthermore, only HCl and CO_2 are generated as by-products through its use. In an initial study we used a commercially available R2+ Vapourtec flow reactor which was configured to mix two reagent streams *via* a T-piece: **stream A** contained *N*-formylglycine (DCM, 0.25 M, 1.0 equiv.), DIPEA (2 equiv.) and DMAP (0.3 equiv.) and **stream B** contained triphosgene (DCM, 0.0875 M, 0.35 equiv.). Using $^1\text{H-NMR}$ analysis of aliquots of the product stream it was quickly established that the desired ethyl isocyanoacetate forms almost quantitatively at room temperature within a 20 min residence time (Scheme 2).

Synthesis of 1,2,4-triazoles in flow

Having developed an efficient protocol for the synthesis of ethyl isocyanoacetate in flow, we next turned our attention to its reaction with various aryl diazonium species, also prepared *in situ*, to furnish a convergent synthesis of 1,2,4-triazoles.¹⁴

To facilitate the reaction, four stock solutions (solutions 1–4) were prepared, along with a small collection of aniline starting materials (solution 5). To perform the multi-step flow sequence an integrated flow reactor configured as shown in

Scheme 3 was constructed. This comprised a Uniqsis FlowSyn with an ALF delivery and control system, a Vapourtec R2+/R4 unit, two auxiliary Knauer K100 HPLC pumps and two Polar bear plus flow reactors (see ESI† for additional details). Using this setup a continuous flow stream of intermediate 3 was prepared as described (see above) and was united with a solution containing the corresponding diazonium coupling partner 6 as a convergent assembly process.

The diazonium component 6 was readily prepared from the precursor aniline or its mono-hydrochloride salts (in MeCN) by treatment with *tert*-butyl nitrite at ambient temperature.¹⁵ For the subsequent cycloaddition reaction the two flow streams containing 3 and 6 were combined and then in succession diluted with a stream of pure ethanol and treated with an aqueous feed of potassium carbonate (5 equiv.). A static mixer was placed in-line to thoroughly blend the flow stream before it passed into a heated reaction coil maintained at 75 °C. The reactor output was collected and worked up by evaporation of the solvent followed by neutralisation with dilute hydrochloric acid and partitioning into ethyl acetate. The products were isolated in high yield and purity after solvent evaporation and trituration of the crude product with a mixture of diethyl ether-ethanol 15:1. Pleasingly the above flow protocol proved general and was applied to the synthesis of a small selection of 1,2,4-triazole products (7a–h) (Fig. 1).

Derivatisation of 1,2,4-triazoles

In order to briefly evaluate the feasibility of these [1,2,4]-triazoles (7a–h) to serve as building blocks towards future research efforts we decided to specifically study the functionalisation of the 5-position of the heterocyclic core. To this end regioselective bromination was affected by treating 7h with a mixture of NaH and NBS in dry THF¹⁶ (Scheme 4). Pleasingly, after 10 h reaction time, complete consumption of the starting material and clean formation of the desired product 8 was observed. After purification 8 was subjected to a small number of Suzuki cross coupling reactions in order to synthesise 9a–c.¹⁷ Although this reaction required prolonged reaction times at elevated temperatures (8–10 h at 120 °C) the desired Suzuki cross coupling products were formed chemoselectively and isolated in reasonable yield allowing further efforts to be directed towards the diversification of these scaffolds.

Synthesis of pyrrolo[1,2-c]pyrimidines in flow

After accomplishing a successful multi-step flow synthesis of various 1,2,4-triazoles we decided to diversify the protocol towards the synthesis of another underexploited scaffold – the pyrrolo[1,2-c]pyrimidine. This structure has shown value for example as the core structure of various nicotinic acetylcholine receptor agonists developed to treat CNS disorders¹⁸ and can be prepared by reacting ethyl isocyanoacetate with readily available pyrrole-2-carboxaldehyde.¹⁹ After a short optimisation study we found that treatment of a flow stream of ethyl isocyanoacetate with a secondary stream containing pyrrole-2-carboxaldehyde (10, 0.25 M, 1.0 equiv.) and piperidine



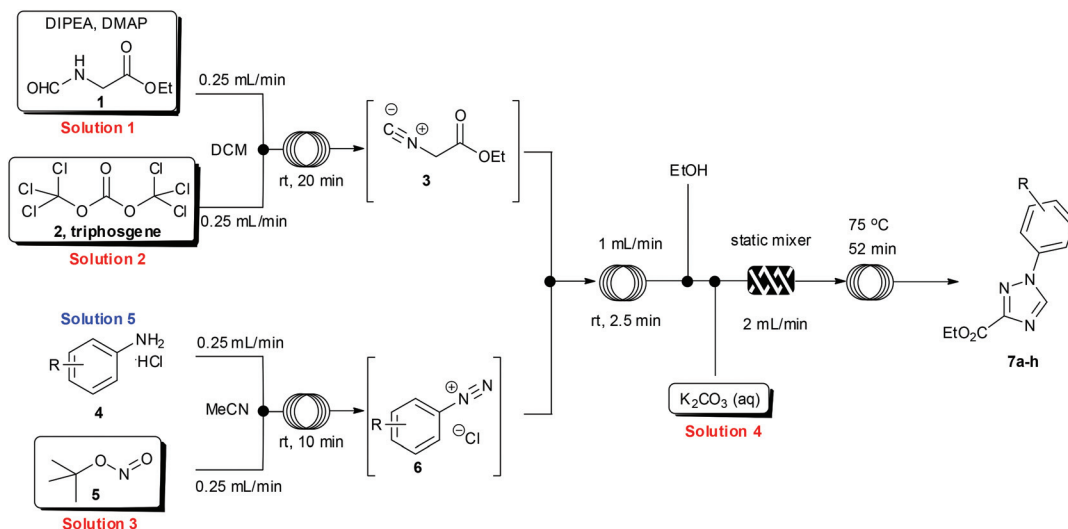

Scheme 3 Multi-step flow approach towards 1,2,4-triazoles.

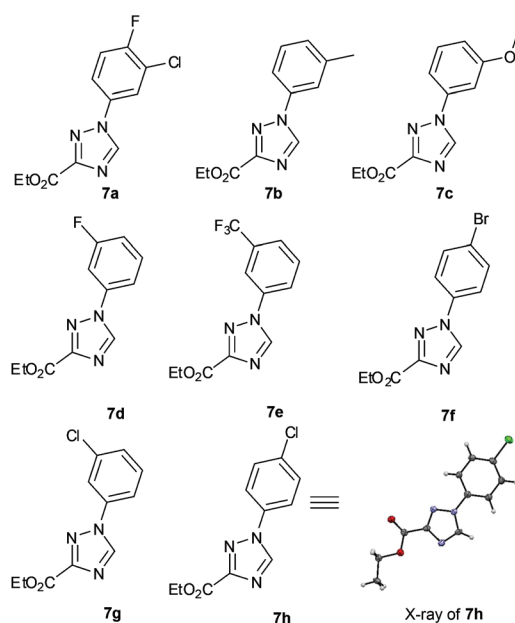
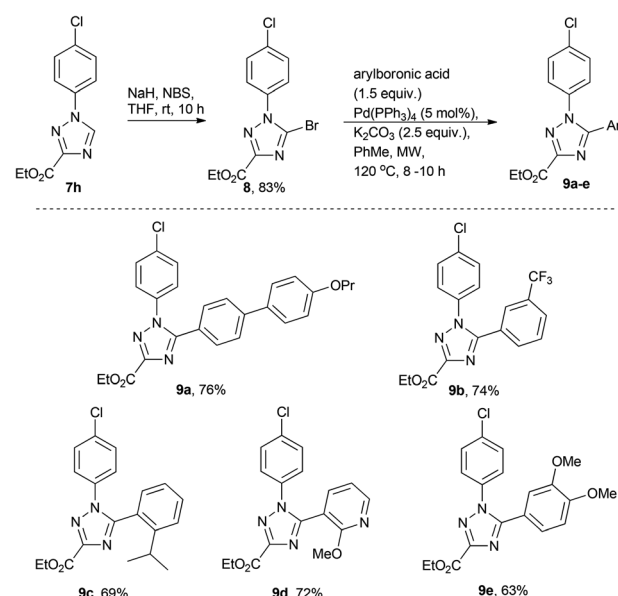

Fig. 1 Representative [1,2,4]-triazoles prepared in flow.



Scheme 4 Functionalization study of triazole 7h.

(6 equiv.) in DCM afforded the desired pyrrolo[1,2-*c*]pyrimidine structure **11** after passing through a flow coil maintained at slightly elevated temperature (85 °C, 26 min residence time, Scheme 5; Fig. 2).

In order to avoid any issues of precipitate formation within the flow system (*i.e.* piperidine-HCl salts) a working concentration of 0.25 M was targeted resulting in a theoretical throughput of 5.71 g h⁻¹. The desired pyrrolo[1,2-*c*]pyrimidine product could be isolated in 85% yield and high purity (>95% by ¹H-NMR) as a beige solid after extraction and evaporation of the volatiles. This crude material was of sufficient quality to be used in further reactions however an analytical sample was

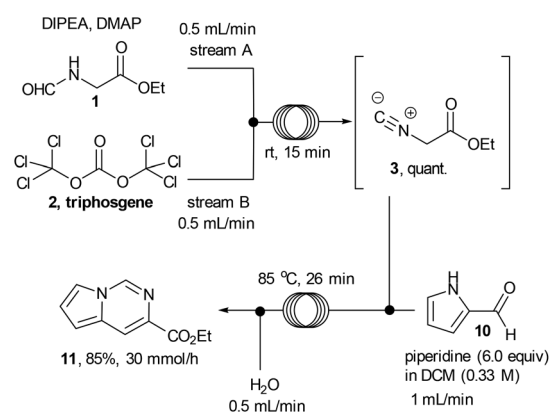
Scheme 5 Multi-step flow approach towards pyrrolo[1,2-*c*]pyrimidine.

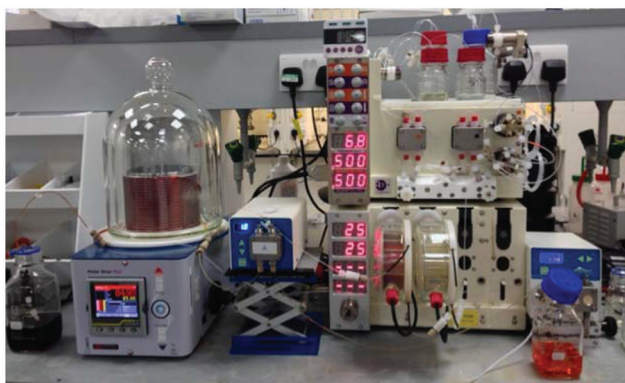
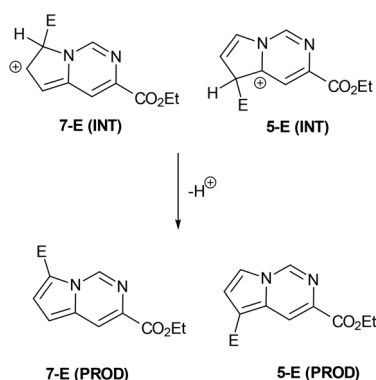

Fig. 2 Flow reactor used for the synthesis of pyrrolo[1,2-*c*]pyrimidine.

further purified by column chromatography to furnish a yellow solid (78%). The reactor could be run under semi-continuous operation delivering ~30 g over the course of a standard working day (8 h) including start-up/shut down and cleaning of the system.

Having established convenient access to multigram quantities of this pyrrolo[1,2-*c*]pyrimidine core (**11**) we decided to evaluate its functionalisation *via* electrophilic aromatic substitution reactions. Specifically we intended to establish whether this scaffold could be decorated in a regioselective manner allowing access to versatile architectures for future synthesis programmes. We therefore performed a number of Density Functional Theory (DFT) calculations to compare the intermediates originating from addition to the most likely C7 and C5 positions of the pyrrole subunit (Scheme 6, Table 1). The geometries of the species were optimised with the 6-311++G(2df,2pd) basis set (for iodine the cc-pVTZ-PP basis set²⁰ with the Stuttgart pseudopotential²¹ was used) employing Truhlar functionals, M06-2X,²² which have been shown to successfully describe the thermochemistry, kinetics, and noncovalent interactions of such systems. The computational calculations were performed using Gaussian 09 program suite,²³ frequency analysis was also performed to confirm the nature of the station-



Scheme 6 General schematic of the DFT calculations performed on the electrophilic attack on the pyrrolopyrimidine moiety.

Table 1 Collected Gibbs free energies on the structures

Entry	Compound	ΔG (Kcal mol ⁻¹) M06-2x/ 6-311++G(2df,2pd)	
		INT ^a	PROD ^a
1	5-Cl	3.23	-1.92
2	7-Cl	0.00	0.00
3	5-Br	1.62	-0.86
4	7-Br	0.00	0.00
5	5-I	0.76	-1.39
6	7-I	0.00	0.00

^a The energies are all reported relative to the 7-halo compounds which were the thermodynamic control compounds.

ary points and to obtain zero-point energies (ZPEs). Solvent effects on molecular geometries and energies were estimated by means of Polarization Continuum Models (PCM)²⁴ with DCM as the solvent.

The data correlated in Table 1, implies a distinct kinetic preference for reaction at the C7 over C5 position due to enhanced delocalisation into the adjacent ring, however the most stable products are those with substitution at C5. Further DFT studies, also confirmed the nucleophilic character of the specified C5 and C7 positions of the pyrrolo[1,2-*c*]pyrimidine (Fig. 3). We were therefore confident that a regioselective functionalisation of the pyrrolopyrimidine could be achieved.

We subsequently prepared a number of pyrrolo[1,2-*c*]pyrimidine derivatives (**12a-i**) confirming that the most reactive site was indeed the C7 position of the pyrrole moiety followed by the C5 position. This analysis was largely enabled by single crystal X-ray diffraction experiments as ¹H- and ¹³C-NMR experiments were not always conclusive (Scheme 7).

Whilst this strategy allowed for the efficient and regioselective monofunctionalisation at C7 *via* halogenation (Cl, Br, I), formylation and acetylation reactions, it was noted that the subsequent introduction of a second electrophilic substituent did not always furnish the predicted product.

The nitration or bromination of the chlorinated pyrrolo[1,2-*c*]pyrimidine intermediate did yield the expected reaction products

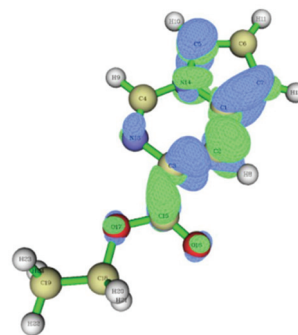
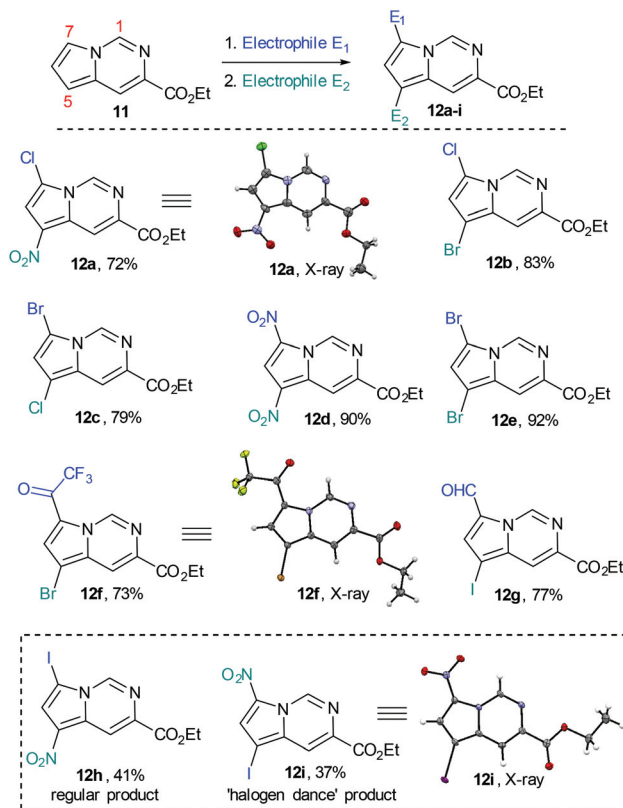

Fig. 3 Dual descriptor Fukui function of pyrrolo[1,2-*c*]pyrimidine (**11**). (green electrophilic regions; blue nucleophilic regions).





Scheme 7 Functionalization of the pyrrolo[1,2-*c*]pyrimidine core by S_EAr reactions (overall isolated yields for 2 steps).

12a and **12b**. However, preparation of the dihalo-structure **12c** was only possible when halogenating (use of NBS or NCS) under neutral conditions. Conducting the chlorination step in the presence of HCl or for prolonged reaction times (*i.e.* >10 h) resulted in the formation of a mixture of **12b** and **12c**.

Additionally, when attempting nitration of substrate **8** it was noted that a mixture of two mono-nitrated products as well as the di-nitrated scaffold **12d** formed very rapidly. Furthermore, attempted nitration of the 7-mono-iodinated pyrrolo[1,2-*c*]pyrimidine core yielded a mixture of nitrated products (**12h**, **12i**) that after longer reaction time (12 h) would also generate small quantities (~15%) of the previously prepared di-nitrated product **12d**. As the identity of **12i** had been confirmed by single crystal X-ray diffraction experiments, we suggest the occurrence of a 'halogen dance' phenomenon in cases where brominated or iodinated monofunctionalisation products are subjected to a second S_EAr reaction under strongly acidic conditions. We thus propose that under acidic conditions the second electrophile is again first introduced at C7 generating a tetrahedral intermediate **13b** (Scheme 8). This structure can then undergo a [1,3]-shift in which the most weakly bound halogen migrates to the 5-position of the pyrrolo [1,2-*c*]pyrimidine scaffold (*i.e.* **13c**) thus resembling other 'halogen dance' phenomena reported in the literature.²⁵ Overall, the strategic use of this rearrangement could lead to

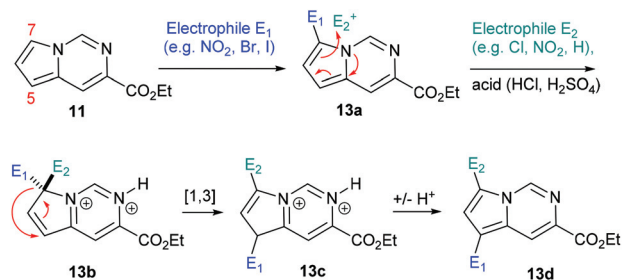

Scheme 8 Proposed mechanism for 'halogen dance' under acidic conditions.

otherwise difficult to access structures and thus opens avenues towards specifically functionalised pyrrolo[1,2-*c*]pyrimidine scaffolds. Further research is now required to fully evaluate and develop these initial findings.

Conclusions

In conclusion, we have successfully developed a valuable flow protocol for the synthesis of ethyl isocyanacetate *via* dehydration of *N*-formylglycine using triphosgene. The versatility of generating this isocyanide building block *in situ* was further exploited by multi-step sequences towards various 1,2,4-triazoles as well as the pyrrolo[1,2-*c*]pyrimidine scaffold, whose further functionalisation by means of S_EAr reactions has been demonstrated. These studies have also allowed insights in the occurrence of halogen dance phenomena during the elaboration of the pyrrolo[1,2-*c*]pyrimidine scaffold. We believe that this study demonstrates the benefits of modern flow techniques in the generation and use of hazardous, yet versatile intermediates towards medicinally relevant structures.

Experimental section

General experimental section

¹H-NMR spectra were recorded on either Bruker Avance-400, Varian VNMRS-600 or Varian VNMRS-700 instruments and are reported relative to residual solvent: CHCl₃ (δ 7.26 ppm) or DMSO (δ 2.50 ppm). ¹³C-NMR spectra were recorded on the same instruments and are reported relative to CHCl₃ (δ 77.16 ppm) or DMSO (δ 39.52 ppm). Data for ¹H-NMR are reported as follows: chemical shift (δ /ppm) (integration, multiplicity, coupling constant (Hz)). Multiplicities are reported as follows: s = singlet, d = doublet, t = triplet, q = quartet, p = pentet, m = multiplet, br. s = broad singlet, app = apparent. Data for ¹³C-NMR are reported in terms of chemical shift (δ /ppm) and multiplicity (C, CH, CH₂ or CH₃). Data for ¹⁹F-NMR were recorded on the above instruments at a frequency of 376 MHz using CFCl₃ as external standard. DEPT-135, COSY, HSQC, HMBC and NOESY experiments were used in the structural assignment. IR spectra were obtained by use of a Perkin Elmer RX1 spectrometer (neat, ATR sampling)



with the intensities of the characteristic signals being reported as weak (w, <20% of tallest signal), medium (m, 21–70% of tallest signal) or strong (s, >71% of tallest signal). Low and high resolution mass spectrometry was performed using the indicated techniques on either Waters LCT Premier XE or Waters TQD instruments equipped with Acquity UPLC and a lock-mass electrospray ion source. For accurate mass measurements the deviation from the calculated formula is reported in ppm. Melting points were recorded on an Optimelt automated melting point system with a heating rate of 1 °C min⁻¹ and are uncorrected.

Single crystal X-ray data were collected at 120.0 K on a Bruker SMART 6000 (sealed tube, graphite monochromator) (compounds **7h** and **SI12f**) and Bruker D8 Venture (Photon 100 CMOS detector, μ S microsource, focusing mirrors) (compounds **12a**, **12f** and **12i**) diffractometers (λ MoK α , λ = 0.71073 Å) equipped with Cryostream (Oxford Cryosystems) open flow nitrogen cryostates. The structures were solved by direct methods and refined by full-matrix least squares on F^2 for all data using SHELX²⁶ and OLEX2²⁷ software. All non-hydrogen atoms were refined with anisotropic displacement parameters, the H-atoms in the structures **12a**, **12f** and **12i** were placed in calculated positions and refined in “riding” mode. The H atoms in the other structures were found in the difference Fourier maps and refined isotropically. Crystallographic data and parameters of the refinement are given in Table 1 (ESI[†]). Crystallographic data for the structures have been deposited with the Cambridge Crystallographic Data Centre as supplementary publication CCDC-1039437–1039441.

Ethyl 1-(3-chloro-4-fluorophenyl)-1H-1,2,4-triazole-3-carboxylate, **7a**. 71%: Mp 186.3–187.9 °C (decomposed). Compound description: tan solid. ¹H NMR (400 MHz, DMSO-*d*₆) δ 9.46 (s, 1H), 8.23 (dd, J = 6.4, 2.7 Hz, 1H), 7.95 (ddd, J = 9.0, 4.2, 2.7 Hz, 1H), 7.69 (t, J = 9.0 Hz, 1H), 4.39 (q, J = 7.1 Hz, 2H), 1.34 (t, J = 7.1 Hz, 3H). ¹³C NMR (101 MHz, DMSO-*d*₆) δ 159.6 (C), 157.3 (d, J = 248.6 Hz, CF), 155.2 (C), 145.0 (CH), 133.8 (d, J = 3.4 Hz, C), 122.9 (CH), 121.5 (d, J = 8.0 Hz, CH), 121.2 (d, J = 19.0 Hz, C), 118.6 (d, J = 22.7 Hz, CH), 61.9 (CH₂), 14.5 (CH₃). ¹⁹F NMR (376 MHz, DMSO-*d*₆) δ -116.21 (s). IR (neat): ν 3116.9 (m), 1721.4 (s), 1511.9 (m), 1493.3 (s), 1451.0 (s), 1339.7 (m), 1252.7 (s), 1202.1 (s), 1089.1 (s), 1051.9 (m), 996.6 (s), 849.9 (s), 828.2 (s), 718.9 (s), 667.6 (s), 639.4 (s) cm⁻¹. LC-MS (ESI): 292.1 (M + Na); HRMS (ESI): calculated for C₁₁H₁₀N₃O₂ClF 270.0446, found 270.0443 (M + H, Δ = -0.3 ppm).

Ethyl 1-(*m*-tolyl)-1H-1,2,4-triazole-3-carboxylate, **7b**. 68%: Mp 80.2–81.5 °C. Compound description: brown powder. ¹H NMR (400 MHz, DMSO-*d*₆) δ 9.43 (s, 1H), 7.74 (dt, J = 1.6, 0.8 Hz, 1H), 7.69 (d, J = 7.8 Hz, 1H), 7.47 (t, J = 7.8 Hz, 1H), 7.29 (d, J = 7.8 Hz, 1H), 4.38 (q, J = 7.1 Hz, 2H), 3.36 (s, 1H), 1.34 (t, J = 7.1 Hz, 3H). ¹³C NMR (101 MHz, DMSO-*d*₆) δ 159.8 (C), 155.0 (C), 144.4 (CH), 140.1 (C), 136.7 (C), 130.1 (CH), 129.7 (CH), 120.8 (CH), 117.4 (CH), 61.8 (CH₂), 21.3 (CH₃), 14.6 (CH₃). IR (neat): 3109.9 (w), 1715.6 (s), 1497.7 (m), 1448.3 (s), 1255.8 (s), 1194.4 (s), 1081.8 (s), 1015.9 (s), 886.1 (m), 848.6 (m), 792.5 (s), 669.4 (s) cm⁻¹. LC-MS (ESI): 254.1 (M + Na);

HRMS (ESI): calculated for C₁₂H₁₄N₃O₂ 232.1086, found 232.1084 (M + H, Δ = -0.2 ppm).

Ethyl 1-(3-methoxyphenyl)-1H-1,2,4-triazole-3-carboxylate, **7c**. 53%: Mp 97.4 °C (decomposed). Compound description: dark brown solid. ¹H NMR (400 MHz, DMSO-*d*₆) δ 9.47 (s, 1H), 7.60–7.38 (m, 3H), 7.06 (ddd, J = 8.0, 2.6, 1.9 Hz, 1H), 4.38 (q, J = 7.1 Hz, 2H), 3.86 (s, 3H), 1.34 (t, J = 7.1 Hz, 3H). ¹³C NMR (101 MHz, DMSO-*d*₆) δ 160.7 (C), 159.7 (C), 155.0 (C), 144.6 (CH), 137.8 (C), 131.3 (CH), 114.9 (CH), 112.4 (CH), 106.0 (CH), 61.8 (CH₂), 56.1 (CH₃), 14.6 (CH₃). IR (neat): 3106.8 (w), 1730.3 (s), 1607.5 (m), 1504.9 (s), 1469.9 (s), 1281.3 (s), 1240.8 (s), 1193.7 (s), 1174.4 (s), 1029.4 (s), 992.2 (s), 882.3 (s), 772.0 (s), 669.4 (s) cm⁻¹. LC-MS (ESI): 270.1 (M + Na); HRMS (ESI): calculated for C₁₂H₁₄N₃O₃ 248.1035, found 248.1035 (M + H, Δ = 0.0 ppm).

Ethyl 1-(3-fluorophenyl)-1H-1,2,4-triazole-3-carboxylate, **7d**. 62%: Mp 214.3 °C (decomposed). Compound description: pale tan solid. ¹H NMR (400 MHz, DMSO-*d*₆) δ 9.50 (s, 1H), 7.84 (dt, J = 10.0, 2.3 Hz, 1H), 7.79 (ddd, J = 8.0, 2.3, 0.9 Hz, 1H), 7.65 (td, J = 8.3, 6.2 Hz, 1H), 7.36 (tdd, J = 8.4, 2.6, 0.9 Hz, 1H), 4.39 (q, J = 7.1 Hz, 2H), 1.34 (t, J = 7.1 Hz, 3H). ¹³C NMR (101 MHz, DMSO-*d*₆) δ 162.8 (d, J = 245.2 Hz, CF), 159.6 (C), 155.2 (C), 144.9 (CH), 138.0 (d, J = 10.6 Hz, C), 132.3 (d, J = 9.2 Hz, CH), 116.4 (d, J = 3.1 Hz, CH), 115.9 (d, J = 21.1 Hz, CH), 108.0 (d, J = 26.8 Hz, CH), 61.9 (CH₂), 14.5 (CH₃). ¹⁹F NMR (376 MHz, DMSO-*d*₆) δ -110.60 (s). IR (neat): 3102.2 (w), 1719.8 (s), 1606.1 (s), 1496.3 (s), 1449.2 (s), 1341.6 (m), 1260.4 (s), 1199.4 (s), 1004.4 (m), 862.5 (s), 783.3 (s), 667.9 (s) cm⁻¹. LC-MS (ESI): 258.1 (M + Na); HRMS (ESI): calculated for C₁₁H₁₁N₃O₂F 236.0835, found 236.0835 (M + H, Δ = 0.0 ppm).

Ethyl 1-(3-(trifluoromethyl)phenyl)-1H-1,2,4-triazole-3-carboxylate, **7e**. 55%: Mp 129.3–130.4 °C. Compound description: orange powder. ¹H NMR (400 MHz, DMSO-*d*₆) δ 9.61 (s, 1H), 8.30 (br s, 1H), 8.28–8.20 (m, 1H), 7.92–7.80 (m, 2H), 4.40 (q, J = 7.1 Hz, 2H), 1.35 (t, J = 7.1 Hz, 3H). ¹³C NMR (101 MHz, DMSO-*d*₆) δ 159.6 (C), 155.3 (C), 145.1 (CH), 137.3 (C), 131.8 (CH), 130.94 (q, J = 32.5 Hz, C), 125.7 (q, J = 3.7 Hz, CH), 124.4 (CH), 124.0 (q, J = 273.6 Hz, CF₃), 117.14 (q, J = 4.0 Hz, CH), 61.9 (CH₂), 14.5 (CH₃). ¹⁹F NMR (376 MHz, DMSO-*d*₆) δ -61.2 (s). IR (neat): 3107.7 (w), 1719.8 (m), 1450.6 (s), 1316.3 (s), 1255.2 (s), 1163.7 (s), 1116.5 (s), 1081.5 (s), 995.1 (m), 902.9 (m), 807.4 (s), 698.8 (s), 668.4 (s) cm⁻¹. LC-MS (ESI): 308.1 (M + Na); HRMS (ESI): calculated for C₁₂H₁₁N₃O₂F₃ 286.0803, found 286.0795 (M + H, Δ = -2.8 ppm).

Ethyl 1-(4-bromophenyl)-1H-1,2,4-triazole-3-carboxylate, **7f**. 69%: Mp 152.4–143.8 °C. Compound description: white crystalline solid. ¹H NMR (400 MHz, DMSO-*d*₆) δ 9.48 (s, 1H), 7.89 (d, J = 8.9 Hz, 2H), 7.82 (d, J = 8.9 Hz, 2H), 4.38 (q, J = 7.1 Hz, 2H), 1.34 (t, J = 7.1 Hz, 3H). ¹³C NMR (101 MHz, DMSO-*d*₆) δ 159.6 (C), 155.2 (C), 144.7 (CH), 136.0 (C), 133.2 (2CH), 122.4 (2CH), 121.8 (C), 61.9 (CH₂), 14.6 (CH₃). IR (neat): 3133.7 (w), 1718.4 (s), 1483.9 (s), 1451.2 (s), 1338.4 (m), 1257.5 (s), 1203.3 (s), 1067.0 (s), 1029.4 (m), 979.8 (s), 826.9 (s), 668.3 (s) cm⁻¹. LC-MS (ESI): 318.0 (M + Na); HRMS (ESI): calculated for C₁₁H₁₁N₃O₂Br 296.0035, found 296.0036 (M + H, Δ = +0.1 ppm).



Ethyl 1-(3-chlorophenyl)-1H-1,2,4-triazole-3-carboxylate, 7g. 68%; Mp 114.6–115.5 °C. Compound description: orange powder. $^1\text{H NMR}$ (400 MHz, DMSO- d_6) δ 9.51 (s, 1H), 8.06 (t, $J = 2.0$ Hz, 1H), 7.90 (ddd, $J = 8.1, 2.1, 1.1$ Hz, 1H), 7.64 (t, $J = 8.1$ Hz, 1H), 7.57 (ddd, $J = 8.1, 2.0, 1.0$ Hz, 1H), 4.39 (q, $J = 7.1$ Hz, 2H), 1.34 (t, $J = 7.1$ Hz, 3H). $^{13}\text{C NMR}$ (101 MHz, DMSO- d_6) δ 159.6 (C), 155.2 (C), 144.9 (CH), 137.9 (C), 134.6 (C), 132.1 (CH), 128.9 (CH), 120.3 (CH), 119.1 (CH), 61.9 (CH₂), 14.5 (CH₃). **IR (neat):** 3109.6 (w), 1719.9 (s), 1595.0 (m), 1485.9 (m), 1450.6 (s), 1341.9 (m), 1256.3 (s), 1198.1 (s), 1103.1 (s), 1079.9 (s), 1028.7 (s), 993.6 (s), 892.9 (s), 846.7 (m), 792.0 (s), 769.0 (s), 667.4 (s) cm^{-1} . **LC-MS (ESI):** 274.0 (M + Na); **HRMS (ESI):** calculated for C₁₁H₁₁N₃O₂Cl 252.0540, found 252.0535 (M + H, $\Delta = -0.5$ ppm).

Ethyl 1-(4-chlorophenyl)-1H-1,2,4-triazole-3-carboxylate, 7h. 67%; Mp 136.5–137.0 °C. Compound description: white crystalline solid. $^1\text{H NMR}$ (400 MHz, DMSO- d_6) δ 9.48 (s, 1H), 7.95 (d, $J = 8.9$ Hz, 2H), 7.68 (d, $J = 8.9$ Hz, 2H), 4.38 (q, $J = 7.1$ Hz, 2H), 1.34 (t, $J = 7.1$ Hz, 3H). $^{13}\text{C NMR}$ (101 MHz, DMSO- d_6) δ 159.6 (C), 155.2 (C), 144.7 (CH), 135.6 (C), 133.4 (C), 130.3 (2CH), 122.2 (2CH), 61.9 (CH₂), 14.6 (CH₃). **IR (neat):** 3125.9 (w), 1725.3 (m), 1487.3 (s), 1450.4 (s), 1339.4 (m), 1257.5 (s), 1202.6 (s), 1074.8 (s), 1028.0 (m), 981.5 (s), 831.2 (s), 668.4 (m) cm^{-1} . **LC-MS (ESI):** 274.1 (M + Na); **HRMS (ESI):** calculated for C₁₁H₁₁N₃O₂Cl 252.0540, found 252.0541 (M + H, $\Delta = +0.1$ ppm). CCDC 1039438.

Ethyl 7-chloro-5-nitropyrrolo[1,2-*c*]pyrimidine-3-carboxylate, 12a. 72%, Mp 145 °C (decomposition). Compound description: brown solid. $^1\text{H NMR}$ (600 MHz, CDCl₃) δ 9.06 (s, 1H), 8.96 (s, 1H), 7.51 (s, 1H), 4.50 (q, $J = 7.2$ Hz, 2H), 1.45 (t, $J = 7.2$ Hz, 3H). $^{13}\text{C NMR}$ (151 MHz, CDCl₃) δ 163.3 (C), 138.6 (C), 135.5 (CH), 129.0 (C), 127.9 (C), 115.5 (CH), 112.5 (CH), 111.5 (C), 62.6 (CH₂), 14.3 (CH₃). **IR (neat):** 3132.5 (w), 1727.3 (s), 1617.9 (w), 1481.0 (s), 1425.5 (m), 1406.5 (m), 1314.6 (s), 1221.6 (s), 1127.7 (s), 1101.3 (s), 1010.2 (m), 973.6 (m), 848.4 (m), 783.7 (s), 759.6 (m) cm^{-1} . **LC-MS (ESI):** 270.10 (M + H); **HRMS (ESI):** calculated for C₁₀H₉N₃O₄Cl 270.0282, found 270.0287 (M + H, $\Delta = 1.9$ ppm). CCDC 1039441.

Ethyl 5-bromo-7-chloropyrrolo[1,2-*c*]pyrimidine-3-carboxylate, 12b. 83%, Mp 109.1–113.0 °C. Compound description: Beige solid. $^1\text{H NMR}$ (400 MHz, CDCl₃) δ 8.77 (d, $J = 1.6$ Hz, 1H), 8.15 (d, $J = 1.6$ Hz, 1H), 6.91 (s, 1H), 4.46 (q, $J = 7.2$ Hz), 1.44 (t, $J = 7.2$ Hz, 3H). $^{13}\text{C NMR}$ (101 MHz, CDCl₃) δ 164.4 (C), 134.8 (CH), 131.4 (C), 128.7 (C), 117.7 (CH), 115.6 (CH), 110.1 (C), 92.5 (C), 61.9 (CH₂), 14.4 (CH₃). **IR (neat):** 1699.8 (s), 1524.7 (m), 1445.7 (m), 1422.2 (m), 1368.0 (m), 1288.4 (s), 1232.1 (s), 1086.4 (m), 1019.8 (m), 813.1 (m), 776.5 (s), 711.1 (m), 593.5 (s) cm^{-1} . **LC-MS (ESI):** 303.4 (M + H); **HRMS (ESI):** calculated for C₁₀H₉N₂O₂ClBr 302.9536, found 302.9541 (M + H, $\Delta = 1.7$ ppm).

Ethyl 5-chloro-7-bromopyrrolo[1,2-*c*]pyrimidine-3-carboxylate, 12c. 79%, Mp 110 °C (decomposition). Compound description: brown solid. $^1\text{H NMR}$ (400 MHz, CDCl₃) δ 8.75 (d, $J = 1.2$ Hz, 1H), 8.14 (d, $J = 1.2$ Hz, 1H), 6.91 (s, 1H), 4.44 (q, $J = 7.2$ Hz, 2H), 1.42 (t, $J = 7.2$ Hz, 3H). $^{13}\text{C NMR}$ (101 MHz, CDCl₃) δ 164.4 (C), 136.0 (CH), 131.1 (C), 128.6 (C), 119.1 (CH),

114.6 (CH), 108.7 (C), 94.4 (C), 61.9 (CH₂), 14.4 (CH₃). **IR (neat):** 1701.2 (s), 1524.6 (m), 1420.1 (m), 1361.7 (m), 1313.0 (m), 1283.0 (s), 1243.8 (s), 1091.9 (m), 1017.4 (m), 821.5 (s), 774.8 (s), 711.5 (s), 594.5 (s) cm^{-1} . **LC-MS (ESI):** 324.9 (M + Na); **HRMS (ESI):** calculated for C₁₀H₈N₂O₂ClBrNa 324.9355, found 324.9358 (M + Na, $\Delta = 0.9$ ppm).

Ethyl 5,7-dinitropyrrolo[1,2-*c*]pyrimidine-3-carboxylate, 12d. 90%, Mp 100.8–103.3 °C. Compound description: yellow-brown solid. $^1\text{H NMR}$ (400 MHz, CDCl₃) δ 10.37 (d, $J = 1.2$ Hz, 1H), 9.18 (d, $J = 1.2$ Hz), 8.46 (s, 1H), 4.55 (q, $J = 7.2$ Hz, 2H), 1.49 (t, $J = 7.2$ Hz, 3H). $^{13}\text{C NMR}$ (101 MHz, CDCl₃) δ 162.4 (C), 142.3 (C), 138.1 (CH), 131.7 (C), 129.5 (C), 127.6 (C), 115.8 (CH), 115.5 (CH), 63.2 (CH₂), 14.3 (CH₃). **IR (neat):** 1729.3 (s), 1500.8 (m), 1475.7 (m), 1334.1 (s), 1239.2 (s), 1139.2 (m), 1005.6 (s), 815.4 (m), 784.7 (s), 764.2 (s), 735.8 (s), 611.0 (m) cm^{-1} . **LC-MS (ESI):** 303.4 (M + Na); **HRMS (ESI):** calculated for C₁₀H₉N₄O₆ 281.0522, found 281.0510 (M + H, $\Delta = -4.3$ ppm).

Ethyl 5,7-dibromopyrrolo[1,2-*c*]pyrimidine-3-carboxylate, 12e. 92%, Mp 113.8–115.5 °C. Compound description: brown solid. $^1\text{H NMR}$ (400 MHz, CDCl₃) δ 8.68 (d, $J = 1.6$ Hz, 1H), 7.99 (d, $J = 1.6$ Hz, 1H), 6.88 (s, 1H), 4.39 (q, $J = 7.2$ Hz, 2H), 1.37 (t, $J = 7.2$ Hz, 3H). $^{13}\text{C NMR}$ (101 MHz, CDCl₃) δ 164.3 (C), 136.1 (CH), 131.5 (C), 130.2 (C), 121.1 (CH), 115.2 (CH), 95.1 (C), 93.2 (C), 61.8 (CH₂), 14.4 (CH₃). **IR (neat):** 1700.7 (s), 1521.5 (w), 1416.9 (s), 1345.0 (s), 1281.7 (s), 1241.1 (s), 1016.2 (s), 823.4 (s), 775.1 (s), 710.9 (s), 593.4 (s) cm^{-1} . **LC-MS (ESI):** 346.8 (M + H); **HRMS (ESI):** calculated for C₁₀H₉N₂O₂Br₂ 346.9031, found 346.9015 (M + H, $\Delta = -4.6$ ppm).

Ethyl 5-bromo-7-(2,2,2-trifluoroacetyl)pyrrolo[1,2-*c*]pyrimidine-3-carboxylate, 12f. 73%, Mp 106.8–108.3 °C. Compound description: beige solid. $^1\text{H NMR}$ (400 MHz, CDCl₃) δ 10.38 (d, 1H, $J = 1.6$ Hz), 8.38 (d, 1H, $J = 1.6$ Hz), 7.86 (q, 1H, $J = 2.0$ Hz), 4.51 (q, 2H, $J = 7.2$ Hz), 1.46 (t, 3H, $J = 7.2$ Hz). $^{13}\text{C NMR}$ (101 MHz, CDCl₃) δ 169.4 (q, $J = 37$ Hz, C), 163.4 (C), 140.0 (CH), 139.3 (C), 137.9 (C), 129.0 (q, $J = 4$ Hz, CH), 118.2 (C), 119.5 (q, $J = 290$ Hz, CF₃), 115.1 (CH), 95.9 (C), 62.7 (CH₂), 14.3 (CH₃). $^{19}\text{F NMR}$ (376 MHz, CDCl₃) δ -71.71 (s). **IR (neat):** 3086.2 (w), 1736.3 (m), 1662.6 (m), 1351.1 (m), 1214.0 (m), 1155.6 (s), 1098.0 (s), 906.3 (m), 851.2 (m), 756.7 (m), 657.6 (m) cm^{-1} . **LC-MS (ESI):** 386.9 (M + Na); **HRMS (ESI):** calculated for C₁₂H₉N₂O₃BrF₃ 364.9749, found 364.9750 (M + H, $\Delta = 0.3$ ppm). CCDC 1039439.

Ethyl 5-iodo-7-formylpyrrolo[1,2-*c*]pyrimidine-3-carboxylate, 12g. 77%, Mp 205 °C (decomposition). Compound description: yellow solid. $^1\text{H NMR}$ (400 MHz, CDCl₃) δ 10.23 (d, $J = 1.2$ Hz, 1H), 9.86 (s, 1H), 8.27 (d, $J = 1.2$ Hz, 1H), 7.75 (s, 1H), 4.51 (q, $J = 7.2$ Hz, 2H), 1.47 (t, $J = 7.2$ Hz, 3H). $^{13}\text{C NMR}$ (101 MHz, CDCl₃) δ 178.2 (CHO), 163.9 (C), 140.2 (CH), 138.6 (C), 138.1 (C), 134.6 (CH), 126.3 (CH), 116.9 (CH), 62.5 (CH₂), 60.5 (C), 14.4 (CH₃). **IR (neat):** 3100.3 (w), 2979.5 (w), 1717.2 (s), 1642.2 (s), 1471.4 (m), 1431.6 (s), 1342.7 (s), 1268.3 (s), 1235.5 (s), 1139.2 (s), 1019.2 (s), 764.1 (s), 729.6 (s), 695.8 (m), 612.0 (m) cm^{-1} . **LC-MS (ESI):** 366.9 (M + Na); **HRMS (ESI):** calculated for C₁₁H₉N₂O₃INa 366.9556, found 366.9557 (M + Na, $\Delta = 0.3$ ppm).



Ethyl 7-iodo-5-nitropyrrolo[1,2-c]pyrimidine-3-carboxylate, 12h. 41%, Mp 150 °C (decomposition). Compound description: brown solid. $^1\text{H NMR}$ (400 MHz, CDCl_3) δ 9.05 (d, $J = 1.4$ Hz, 1H), 8.89 (d, $J = 1.4$ Hz, 1H), 7.79 (s, 1H), 4.52 (q, $J = 7.2$ Hz, 2H), 1.47 (t, $J = 7.2$ Hz, 3H). $^{13}\text{C NMR}$ (101 MHz, CDCl_3) δ 163.4 (C), 140.0 (CH), 138.9 (C), 132.7 (C), 130.7 (C), 123.5 (CH), 115.1 (CH), 63.1 (C), 62.6 (CH_2), 14.3 (CH_3). **IR (neat):** 1699.6 (s), 1486.6 (m), 1406.2 (s), 1296.4 (s), 1276.6 (s), 1215.5 (s), 1012.2 (s), 779.6 (s), 756.3 (s), 598.1 (s) cm^{-1} . **LC-MS (ESI):** 361.9 (M + H); **HRMS (ESI):** calculated for $\text{C}_{10}\text{H}_9\text{N}_3\text{O}_4\text{I}$ 361.9638, found 361.9633 (M + H, $\Delta = -1.4$ ppm).

Ethyl 5-iodo-7-nitropyrrolo[1,2-c]pyrimidine-3-carboxylate, 12i. 37%, Mp 170 °C (decomposition). Compound description: bright yellow solid. $^1\text{H NMR}$ (400 MHz, CDCl_3) δ 10.18 (d, $J = 1.2$ Hz, 1H), 8.32 (d, $J = 1.2$ Hz, 1H), 8.07 (s, 1H), 4.55 (q, $J = 7.2$ Hz, 2H), 1.50 (t, $J = 7.2$ Hz, 3H). $^{13}\text{C NMR}$ (101 MHz, CDCl_3) δ 163.4 (C), 138.4 (CH), 138.1 (C), 137.0 (C), 132.4 (C), 126.6 (CH), 117.1 (CH), 62.7 (CH_2), 60.9 (C), 14.3 (CH_3). **IR (neat):** 1712.2 (m), 1505.4 (m), 1436.4 (s), 1381.0 (s), 1313.5 (s), 1282.7 (s), 1211.5 (s), 1020.0 (m), 813.3 (m), 722.6 (s) cm^{-1} . **LC-MS (ESI):** 361.9 (M + H); **HRMS (ESI):** calculated for $\text{C}_{10}\text{H}_9\text{N}_3\text{O}_4\text{I}$ 361.9638, found 361.9644 (M + H, $\Delta = 1.7$ ppm). CCDC 1039440.

Acknowledgements

We gratefully acknowledge financial support through the Royal Society (M.B. and I.R.B.) and MEC & MINECO for a FPU fellowship (A.M.R.G.). Furthermore we are very grateful to Dr D. S. Yufid and Dr A. S. Batsanov (Department of Chemistry, Durham University) for solving several X-ray crystal structures.

Notes and references

- (a) J. J. Li, *Heterocyclic Chemistry in Drug Discovery*, Wiley, 2013. ISBN: 978-1-118-14890-7; (b) R. B. Silverman, *The Organic Chemistry of Drug Design and Drug Action*, Elsevier Academic Press, Burlington, MA, 2004; (c) H. Wild, D. Heimbach and C. Huwe, *Angew. Chem., Int. Ed.*, 2011, **50**, 7452.
- (a) M. Baumann, I. R. Baxendale, S. V. Ley and N. Nikbin, *Beilstein J. Org. Chem.*, 2011, **7**, 442; (b) M. Baumann and I. R. Baxendale, *Beilstein J. Org. Chem.*, 2013, **9**, 2265; (c) E. Vitaku, D. T. Smith and J. T. Njardarson, *J. Med. Chem.*, 2014, **57**, 10257.
- (a) L. Malet-Sanz and F. Susanne, *J. Med. Chem.*, 2012, **55**, 4062; (b) M. Baumann, I. R. Baxendale and S. V. Ley, *Mol. Diversity*, 2011, **15**, 613; (c) R. L. Hartman, J. P. McMullen and K. F. Jensen, *Angew. Chem., Int. Ed.*, 2011, **50**, 7502; (d) C. Wiles and P. Watts, *Green Chem.*, 2012, **14**, 38; (e) V. Hessel, B. Cortese and M. H. J. M. de Croon, *Chem. Eng. Sci.*, 2011, **66**, 1426; (f) J. Yoshida, H. Kim and A. Nagaki, *ChemSusChem*, 2010, **4**, 331; (g) M. D. Hopkin, I. R. Baxendale and S. V. Ley, *Org. Biomol. Chem.*, 2013, **11**, 1822.
- (a) I. R. Baxendale, L. Brocken and C. J. Mallia, *Green Process Synth.*, 2013, **2**, 211; (b) I. R. Baxendale, *J. Chem. Technol. Biotechnol.*, 2013, **88**, 4, 519; (c) J. Wegner, S. Ceylan and A. Kirschning, *Adv. Synth. Catal.*, 2012, **354**, 17; (d) J. C. Pastre, D. L. Browne, M. O'Brien and S. V. Ley, *Org. Process Res. Dev.*, 2013, **17**, 1183; (e) M. A. Kabeshov, B. Musio, P. R. D. Murray, D. L. Browne and S. V. Ley, *Org. Lett.*, 2014, **16**, 4618; (f) J. Wegner, S. Ceylan and A. Kirschning, *Org. Biomol. Chem.*, 2012, **10**, 7721; (g) P. R. D. Murray, D. L. Browne, J. C. Pastre, C. Butters, D. Guthrie and S. V. Ley, *Org. Process Res. Dev.*, 2013, **17**, 1192.
- (a) M. O'Brien, I. R. Baxendale and S. V. Ley, *Org. Lett.*, 2010, **12**, 1596; (b) C. Battilochio, I. R. Baxendale, M. Biava, M. O. Kitching and S. V. Ley, *Org. Process Res. Dev.*, 2012, **16**, 798; (c) M. Irfan, T. N. Glasnov and C. O. Kappe, *Org. Lett.*, 2011, **13**, 984.
- (a) C. J. Smith, C. D. Smith, N. Nikbin, S. V. Ley and I. R. Baxendale, *Org. Biomol. Chem.*, 2011, **9**, 1927; (b) H. R. Sahoo, J. G. Kralj and K. F. Jensen, *Angew. Chem., Int. Ed.*, 2007, **46**, 5704; (c) L. Kupracz, J. Hartwig, J. Wegner, S. Ceylan and A. Kirschning, *Beilstein J. Org. Chem.*, 2011, **7**, 1441; (d) M. Baumann, I. R. Baxendale, S. V. Ley, N. Nikbin, C. D. Smith and J. P. Tierney, *Org. Biomol. Chem.*, 2008, **6**, 1577; (e) C. J. Smith, N. Nikbin, S. V. Ley, H. Lange and I. R. Baxendale, *Org. Biomol. Chem.*, 2011, **9**, 1938; (f) P. B. Palde and T. F. Jamison, *Angew. Chem., Int. Ed.*, 2011, **50**, 3525; (g) I. R. Baxendale, S. V. Ley, A. C. Mansfield and C. D. Smith, *Angew. Chem., Int. Ed.*, 2009, **48**, 4017; (h) F. R. Bou-Hamdan, F. Lévesque, A. G. O'Brien and P. H. Seeberger, *Beilstein J. Org. Chem.*, 2011, **7**, 1124; (i) C. D. Smith, I. R. Baxendale, S. Lanners, J. J. Hayward, S. C. Smith and S. V. Ley, *Org. Biomol. Chem.*, 2007, **5**, 1559; (j) C. J. Smith, N. Nikbin, C. D. Smith, S. V. Ley and I. R. Baxendale, *Org. Biomol. Chem.*, 2011, **9**, 1927; (k) M. M. E. Delville, P. J. Nieuwland, P. Janssen, K. Koch, J. C. M. van Hest and F. P. J. T. Rutjes, *Chem. Eng. J.*, 2011, **167**, 556.
- (a) D. X. Hu, M. O'Brien and S. V. Ley, *Org. Lett.*, 2012, **14**, 4246; (b) L. Malet-Sanz, J. Madrzak, S. V. Ley and I. R. Baxendale, *Org. Biomol. Chem.*, 2010, **8**, 3312.
- (a) C. McPake, C. B. Murray and G. Sandford, *Tetrahedron Lett.*, 2009, **50**, 1674; (b) C. McPake and G. Sandford, *Org. Process Res. Dev.*, 2012, **16**, 844; (c) J. R. Breen, G. Sandford, D. S. Yufid, J. A. K. Howard, J. Fray and B. Patel, *Beilstein J. Org. Chem.*, 2011, **7**, 1048.
- (a) D. L. Browne, M. Baumann, B. H. Harji, I. R. Baxendale and S. V. Ley, *Org. Lett.*, 2011, **13**, 3312; (b) J. A. Newby, D. W. Blaylock, P. M. Witt, J. C. Pastre, M. K. Zacharova, S. V. Ley and D. L. Browne, *Org. Process Res. Dev.*, 2014, **18**, 1211; (c) A. Nagaki, A. Kenmoku, Y. Moriwaki, A. Hayashi and J. Yoshida, *Angew. Chem., Int. Ed.*, 2010, **49**, 7543; (d) A. Nagaki, E. Takizawa and J. Yoshida, *Chem. – Eur. J.*, 2010, **16**, 14149.



- 10 (a) J. Hartwig, S. Ceylan, L. Kupracz, L. Coutable and A. Kirschning, *Angew. Chem., Int. Ed.*, 2013, **52**, 9813; (b) J. Hartwig, L. Kupracz and A. Kirschning, *Chem. Lett.*, 2012, **41**, 562; (c) B. Reichart and C. O. Kappe, *Tetrahedron Lett.*, 2012, **53**, 952; (d) J. Yoshida, *Flash Chemistry: Fast Organic Synthesis in Microsystems*, John Wiley & Sons, Chichester, UK, 2008.
- 11 (a) K. Matsumoto and M. Suzuki, *Ethyl Isocyanoacetate; Encyclopedia of Reagents for Organic Synthesis*, 2001; (b) M. Sugimoto and Y. Ito, *Sci. Synth.*, 2004, **19**, 445; (c) S. Kotha and S. Halder, *Synlett*, 2010, 337; (d) M. Baumann, I. R. Baxendale, S. V. Ley, C. D. Smith and G. K. Tranmer, *Org. Lett.*, 2006, **8**, 5231.
- 12 N-formylglycine is commercially available (CAS 3154-51-6).
- 13 S. Fuse, N. Tanabe and T. Takahashi, *Chem. Commun.*, 2011, **47**, 12661.
- 14 K. Matsumoto, M. Suzuki, M. Tomie, N. Yoneda and M. Miyoshi, *Synthesis*, 1975, 609.
- 15 D. L. Browne, I. R. Baxendale and S. V. Ley, *Tetrahedron*, 2011, **67**, 10296–10303.
- 16 M. Zibinsky and V. V. Fokin, *Org. Lett.*, 2011, **13**, 4870.
- 17 R. Romagnoli, P. G. Baraldi, O. Cruz-Lopez, C. Lopez Cara, M. D. Carrion, A. Brancale, E. Hamel, L. Chen, R. Bortolozzi, G. Basso and G. Viola, *J. Med. Chem.*, 2010, **53**, 4248.
- 18 For instance WO 2003070732; WO 2004039366; WO 2004064836; WO 2004052461.
- 19 (a) J. M. Minguez, J. J. Vaquero, J. L. García-Navio and J. Alvarez-Builla, *Tetrahedron Lett.*, 1996, **37**, 4263; (b) J. M. Minguez, J. J. Vaquero, J. Alvarez and O. Catano, *J. Org. Chem.*, 1999, **64**, 7788.
- 20 K. A. Peterson, B. C. Shepler, D. Figgen and H. Stoll, *J. Phys. Chem. A*, 2006, **110**, 13877.
- 21 K. A. Peterson, D. Figgen, E. Goll, H. Stoll and M. Dolg, *J. Chem. Phys.*, 2003, **119**, 11113.
- 22 (a) Y. Zhao and D. G. Truhlar, *Acc. Chem. Res.*, 2008, **41**, 157; (b) Y. Zhao and D. G. Truhlar, *Theor. Chem. Acc.*, 2007, **120**, 215.
- 23 M. J. Frisch, G. W. Trucks, H. B. Schlegel, G. E. Scuseria, M. A. Robb, J. R. Cheeseman, G. Scalmani, V. Barone, B. Mennucci, G. A. Petersson, H. Nakatsuji, M. Caricato, X. Li, H. P. Hratchian, A. F. Izmaylov, J. Bloino, G. Zheng, J. L. Sonnenberg, M. Hada, M. Ehara, K. Toyota, R. Fukuda, J. Hasegawa, M. Ishida, T. Nakajima, Y. Honda, O. Kitao, H. Nakai, T. Vreven, J. A. Montgomery Jr., J. E. Peralta, F. Ogliaro, M. J. Bearpark, J. J. Heyd, E. N. Brothers, K. N. Kudin, V. N. Staroverov, R. Kobayashi, J. Normand, K. Raghavachari, A. P. Rendell, J. C. Burant, S. S. Iyengar, J. Tomasi, M. Cossi, N. Rega, N. J. Millam, M. Klene, J. E. Knox, J. B. Cross, V. Bakken, C. Adamo, J. Jaramillo, R. Gomperts, R. E. Stratmann, O. Yazyev, A. J. Austin, R. Cammi, C. Pomelli, J. W. Ochterski, R. L. Martin, K. Morokuma, V. G. Zakrzewski, G. A. Voth, P. Salvador, J. J. Dannenberg, S. Dapprich, A. D. Daniels, Ö. Farkas, J. B. Foresman, J. V. Ortiz, J. Cioslowski and D. J. Fox, *GAUSSIAN 09 (Revision D.01)*, Gaussian Inc., Wallingford CT, 2009, 2009.
- 24 (a) S. Miertuš, E. Scrocco and J. Tomasi, *Chem. Phys.*, 1981, **55**, 117; (b) J. Tomasi, R. Cammi, B. Mennucci, C. Cappelli and S. Corni, *Phys. Chem. Chem. Phys.*, 2002, **4**, 5697; (c) J. Tomasi, B. Mennucci and R. Cammi, *Chem. Rev.*, 2005, **105**, 2999.
- 25 (a) M. Vicinius Nora de Souza, *Curr. Org. Chem.*, 2007, **11**, 637; (b) M. Schnürch, M. Spina, A. Farooq Khan, M. D. Mihovilovic and P. Stanetty, *Chem. Soc. Rev.*, 2007, **36**, 1046; (c) M. Schnürch, Recent Progress on the Halogen Dance Reaction on Heterocycles, in *Halogenated Heterocycles, Topics in Heterocyclic Chemistry*, Springer, 2012, vol. 27, pp. 185–218.
- 26 G. M. Sheldrick, *Acta Crystallogr., Sect. A: Fundam. Crystallogr.*, 2008, **64**, 112–122.
- 27 O. V. Dolomanov, L. J. Bourhis, R. J. Gildea, J. A. K. Howard and H. Puschmann, *J. Appl. Crystallogr.*, 2009, **42**, 339–341.

