

Cite this: *Sustainable Energy Fuels*,
2017, 1, 1541

Process exploration and assessment for the production of methanol and dimethyl ether from carbon dioxide and water†

A. Hankin * and N. Shah 

A thermodynamic, model-based, study was carried out to assess the relative performance of methanol and dimethyl ether (DME) synthesis systems using CO- and CO₂-based syngas feeds. The upstream production of a range of syngas feed compositions was simulated using CO₂ and H₂O as the sole chemical building blocks, a requirement motivated by the increasing constraints on permissible CO₂ emissions and the successful adaptation by some industrial methanol plants to the direct utilisation of CO₂. The objective was to establish whether the energy requirements and CO₂ emissions associated with upstream conversion of CO₂ to CO were justified by increased productivity in the methanol/DME systems. In the first part of the study, the performance of four systems was evaluated and compared in terms of energy efficiency and CO₂ conversion: (1) methanol synthesis system, (2) direct DME synthesis system, (3) two-step DME synthesis system with an interposed syngas separation step between the methanol production reactor and methanol dehydration reactor and (4) two-step DME synthesis system with no separation step between the two reactors. Based on equilibrium yields at 250 °C and 50 bar, the direct DME synthesis system was found to exhibit the highest energy conversion efficiencies with both CO₂- and CO-based syngas. Although this system demonstrated the lowest CO₂ emissions per methanol equivalent product with a CO-based feed, the benefits were offset by emissions associated with the upstream conversion of H₂O and CO₂ to H₂ and CO, evaluated in the second part of the study. It was determined that CO₂ could be utilised directly in the direct DME synthesis route, whereas upstream conversion of CO₂ to CO was necessary to achieve effective yields in the methanol/two-step DME systems. CO-based syngas production *via* high temperature co-electrolysis of H₂O and CO₂, or alternatively high temperature CO₂ electrolysis coupled with the water–gas shift process, was identified as the best technology based on energy consumption and CO₂ utilisation.

Received 19th April 2017
Accepted 20th June 2017

DOI: 10.1039/c7se00206h

rsc.li/sustainable-energy

Introduction

Presently, dense energy carriers with applications in energy storage, such as methanol and dimethyl ether (DME) are, for economic reasons, derived principally from fossil fuels.¹ Typically, syngas is first generated from either natural gas or coal and subsequently converted to methanol, DME or other liquid hydrocarbons *via* the Fischer–Tropsch process. These processes release CO₂. For example, conventional methanol production plants can release over 5 t(CO₂)/t(methanol),² depending on the feedstock. However, emissions of CO₂ and other greenhouse gases (GHG) into the atmosphere are becoming a global concern and regulations requiring their minimisation are being put in place.³ One of the consequences will be the gradual decarbonisation of energy sources, which is expected to

decrease the overall demand for coal and gas.⁴ Consequently, alternative choices of raw materials, as well as the re-design of processes that would enable the minimisation of CO₂ emissions, are required. Indeed this is the basis for the concept of the methanol economy,⁵ in which CO₂ is recycled into methanol and DME for energy storage or conversion to other synthetic fuels in order to reduce dependence on fossil fuels and to mitigate the rate of global warming.

Investigation of direct and indirect utilisation of CO₂ in methanol and DME synthesis processes was the focus of this study because of their industrial importance and large scale production.¹ Methanol is used in the manufacture of chemicals, such as formaldehyde, methyl *tert*-butyl ether (MTBE) and acetic acid, as well as plastics. It can be transformed into petrochemicals or blended with them for use in internal combustion engines;⁶ it can also be used in fuel cells.⁷ DME, the dehydration product of methanol, is a non-toxic chemical with uses in household products, aerosol propellants, paints and, like methanol, can be used as a fuel either directly or in a blend,^{7,8} for example with liquefied petroleum gas (LPG). DME has

Department of Chemical Engineering, Imperial College London, London, SW7 2AZ, UK.
E-mail: anna.hankin@imperial.ac.uk

† Electronic supplementary information (ESI) available. See DOI: 10.1039/c7se00206h



already replaced diesel fuel in the engines of some vehicles, demonstrating improved environmental performance.^{9,10} The advantage of both methanol and dimethyl ether is that they do not generate carbonaceous particulate matter upon combustion.

Encouragingly, several projects have now demonstrated that methanol can be synthesized directly from CO₂ captured from large point sources, such as power plants, and H₂ generated electrochemically from H₂O.^{11–14} These processes utilise modified catalysts with greater tolerance to water build-up and also larger fractions of hydrogen to carbon in the system feeds than those used in conventional processes.

The feasibility of direct CO₂ utilisation on an industrial scale confirms that the widely reported problems associated with slow CO₂ dehydrogenation kinetics and catalyst deactivation are surmountable. Hence, the purpose of this study was to re-examine and compare the thermodynamic constraints on methanol as well as DME syntheses from CO- and CO₂-based syngas using system analysis in Aspen Plus V8.8. The goal was to identify the theoretical differences between system efficiencies when CO and CO₂ were the principal sources of carbon to the synthesis steps and whether in certain situations a CO₂-based feed could be preferable to a CO-based one. Equilibrium syngas conversion was investigated in four systems:

1. Methanol synthesis;
2. Direct DME synthesis (methanol dehydration occurring simultaneously with CO/CO₂ hydrogenation);
3. Two-step DME synthesis (methanol synthesis and methanol dehydration occurring in two separate stages) with an interposed unreacted syngas separation step;
4. Two-step DME synthesis with no separation step between the two reactors.

In the first part of the study, system efficiencies and extents of CO₂ conversion were examined for Stage 2 in Fig. 1 as a function of hydrogen to total carbon molar ratios, H₂ : (CO₂ + CO), in the system feed. The total molar carbon flux : (CO₂ + CO) was fixed, while the CO₂ : CO ratio was varied between 1 and ≈ 0 in order to determine the theoretical limitations imposed when CO₂ rather than CO was supplied to the conversion systems. Efficiencies were evaluated as quotients of the net energies produced in Stage 2 and the energies contained in the syngas entering Stage 2. Net energies were computed based on energies

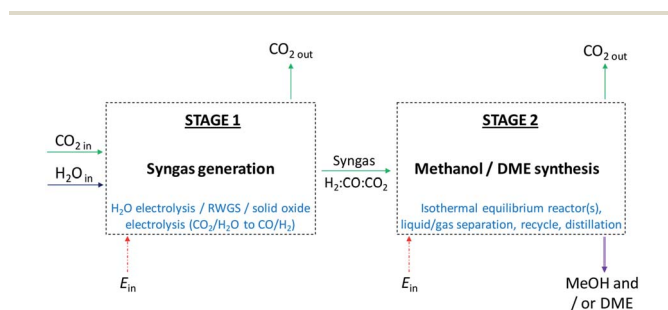

Fig. 1 Principal stages in methanol and DME syntheses from CO₂ and H₂O. In Stage 1, CO₂ and H₂O are converted to CO and H₂ (syngas); in cases where CO₂ is utilised directly only H₂ is generated in Stage 1. In Stage 2, syngas is converted to methanol and/or DME.

extracted in the form of methanol and DME and energies required to support the operation of heaters, compressors and distillation columns in the systems. The energy contained in the syngas was based on the lower heating values of hydrogen and carbon monoxide. Various energy saving mechanisms were examined, including the combustion of vented gases and the coupling of heat exchangers.

In the second part of the study, possible routes to syngas compositions identified as optimum for Stage 2 were explored. Energy requirements were estimated and compared against the benefits of utilising CO over CO₂ in Stage 2. Decontaminated CO₂ and H₂O were assumed to be the sole building blocks for syngas generation in Stage 1, as shown in Fig. 1, hence respecting the system boundary.

Potential disparities between thermodynamic predictions and kinetics were not considered in this study because the broad range of feed compositions under investigation here has not been covered by a complete set of kinetic data and because the wide range of kinetic data available for different catalysts cannot be readily distilled to parameters applicable across the whole range of syngas compositions.

Industrial processes

The chemical reactions and process layouts for methanol and DME synthesis, as well as examples of industrial processes, are described below.

Industrial production of methanol and dimethyl ether

Methanol production from syngas. Methanol is principally formed by the hydrogenation of CO (1) but can also be synthesized by hydrogenation of CO₂ (2). The water gas shift reaction (WGS) (3) takes place simultaneously with (1) and (2). Copper based catalysts such as Cu/ZnO, employed most commonly, catalyse all three processes.^{11,13,15}

A general process layout for industrial methanol production is shown in Fig. 2. Fresh syngas is fed into a methanol reactor, which is operated at temperatures in the range of 150–300 °C and under pressures in the range 10–100 bar,¹¹ although typical

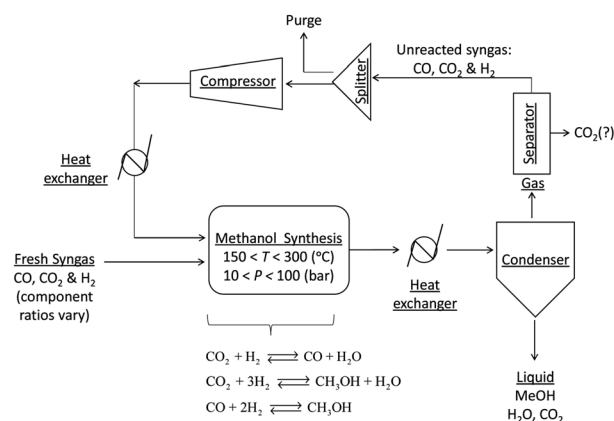
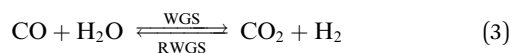
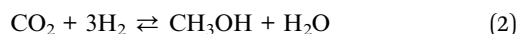
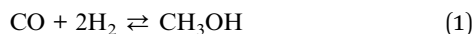

Fig. 2 A general process layout for a commercial methanol production system.



conditions are 250–260 °C and 50–60 bar. A large number of reactor designs have been commercialised, but generally these are operated either under adiabatic or isothermal conditions.⁷ In both reactor types, the control of reactor temperatures is one of the principal challenges because reactions (1)–(3) are exothermic and can cause temperatures to rise above 300 °C, at which catalyst deactivation often occurs.¹



The reactor effluent, which contains methanol, water and unreacted syngas is cooled to condense out the methanol, water and any absorbed CO₂. Methanol is generally separated by distillation.¹¹ After separation from methanol and water, the unreacted gases may be processed further, for example to remove the CO₂, and then recycled into the reactor. CO₂ is then vented or recycled further upstream.

Although CO₂ is reported to have an adverse effect on methanol synthesis rates, studies with isotopic labelling¹⁶ on a commercial Cu/ZnO/Al₂O₃ catalyst showed that in fact a certain quantity of CO₂ in the syngas (4–8%) is essential to make conversion to methanol possible as CO₂ is the principal source of carbon in the methanol^{7,17} and also to protect catalysts from deactivation.¹⁸

There are presently three industrial methanol synthesis plants that exclusively utilise CO₂ and H₂. Mitsui Chemicals' Osaka Works combines purified CO₂ exhaust with H₂ produced by water electrolysis to generate methanol.¹¹ Catalysts able to tolerate high water levels, caused by reaction (2) and the reverse water gas shift reaction (3) (RWGS), were specifically developed for these conditions. CO₂ was not removed from the recycle loop, while a portion of the unreacted gases was combusted to supply heat to other parts of the system.

Carbon Recycling International (CRI) produces 4000 t per year of renewable methanol (Vulcanol™) by direct synthesis using carbon dioxide, sourced from flue gas released by a geothermal power plant, and hydrogen, generated from renewably powered water electrolysis.¹² This process is reported to reduce carbon emissions by more than 85% compared with plants that utilise syngas derived from fossil fuels.¹⁹ The methanol is subsequently blended with gasoline to power cars. Two methods are potentially used to achieve CO₂ and H₂ conversion. In the first method, the CO₂ and H₂, undergo the RWGS reaction;²⁰ following the removal of water from the product stream by condensation, and separation of CO₂ by isothermal compression, hydrogen is added to the remaining product stream to achieve the ratio H₂ : CO of 2 : 1, before being fed into the methanol reactor. In the second method, H₂ and CO₂, in a ratio of 7 : 2, are reacted directly to form methanol and CO.

Blue Fuel Energy is amongst the next producers of renewable methanol from captured CO₂ and H₂ produced in an electrolyser powered by renewables, and to convert it to gasoline.¹⁴ Net

greenhouse gas (GHG) emissions are expected to be heavily influenced by the H₂ production process;²¹ however, preliminary figures suggest a reduction in CO₂ emissions by 65–84% relative to fossil fuel based processes.¹⁹

In terms of capital investment, methanol synthesis from CO₂ and H₂ has been estimated to be approximately the same as that for a conventional plant.¹ The principal limiting factor for scale-up of such processes is said to be the availability and price of CO₂ and H₂ and the source of electrical energy.

The systems reported to date use a range of H₂ : carbon ratios, depending on whether CO or CO₂ is used in the feed. A stoichiometric ratio of 2, as defined by eqn (4), is preferred for syngas with high CO : CO₂ ratios.

$$S_R = \frac{(\text{H}_2 - \text{CO}_2)}{(\text{CO} + \text{CO}_2)} \quad (4)$$

However, often for kinetic reasons a value slightly higher than 2 is employed in industry. For example, the isothermal Lurgi Methanol Converter uses $S_R = 2.05\text{--}2.1$;²² Haldor Topsoe use $S_R = 2$. On the other hand, for processes employing direct conversion of CO₂ and H₂ to methanol, a ratio of 3.5 was used¹³ and a ratio of 5.0 was specified as optimum.¹¹ The higher than 2 ratio is designed to decrease the molar fraction of water so as to limit its adsorption onto the catalyst. In this way, the decrease in the methanol production efficiency can be mitigated. One of the objectives of this study was to identify the optimum thermodynamic H₂ : CO₂ ratios in the system feeds when CO₂ was utilised directly for the production of methanol/DME.

Dimethyl ether production from syngas. Dimethyl ether is produced *via* the dehydration of methanol by reaction (5) over solid acid catalysts such as gamma alumina (γ-Al₂O₃), silica alumina, activated alumina or ZSM-5 (zeolite-based catalysts).^{23,24} This process requires temperatures and pressures in the ranges of 210–290 °C and 30–100 bar, respectively, and hence is wholly compatible with methanol production conditions.

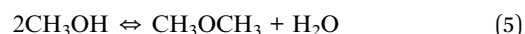

Reaction (5) can take place in a designated reactor, into which methanol, produced in a separate reactor *via* (1), (3) and/or (2), is fed. Alternatively, both the production and dehydration of methanol can take place in the same reactor that utilises bi-functional catalysts, such as Cu/ZnO/γ-Al₂O₃. The former and the latter production methods are commonly referred to as the 'two-step process' and direct 'one-step process', respectively.

If only CO and H₂ are present in the reactor system feed, the overall reaction is:

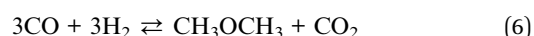

The stoichiometric requirement for the H₂ : CO ratio in the feed is 1 : 1. Notably, this process will result in the generation of CO₂. This drawback could be resolved by recycling and using CO₂ in the process by which syngas is produced, be it dry methane reforming or reduction to CO in high temperature



solid oxide electrolyser. However, in terms of CO₂ emissions, the preferred option would be to minimise the generation of CO₂, such that separation and recycle costs could be minimised, and that the DME production process would always result in net CO₂ utilisation. If CO₂ is present in the system feed together with CO and H₂, the overall process reaction becomes:

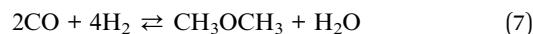

Hence, net CO₂ production by the reactor could be minimised, provided the ratio of CO₂ : CO : H₂ in the system feed is optimised in order for thermodynamics and kinetics to be favourable.

An additional issue is the generation of water by reactions (5) and (7), resulting in CO₂ and H₂ production by the WGS reaction (3). While H₂ is beneficial for CO conversion *via* reaction (1), the production of CO₂ is not and serves to reverse the benefits of reaction (2). If one of the principal goals is CO₂ mitigation, then the constraints on the process must include the requirement that less CO₂ is produced than is consumed. Therefore, this places a lower limit on the H₂ : (CO₂ + CO) ratio that can be used in the system feed. The degree of syngas conversion and CO₂ emissions depend greatly on the type of process used: there are two principal options.

Two-step process. The two-step process is the more conventional method for DME production and is currently employed by companies such as Haldor Topsoe, Toyo Engineering (TEC), Oberon Fuels, BioDME and Lurgi (Air Products). With this approach, a methanol dehydration reactor, typically a fixed bed catalytic system, may be connected to an existing methanol production facility and used when required. Furthermore, the separate dehydration step is reported to require low capital investment, provided there is high feedstock availability. The maturity of the available technology for obtaining methanol and the relative simplicity of methanol dehydration are the great attractions of the two-step process. Furthermore, the limited activity of the solid acid dehydration catalysts for the water gas shift reaction at low temperatures results in only small amounts of CO₂ generated by reaction (3) in the second step; the same is not true for the one-step system, where the catalyst used for converting syngas to methanol also has a high activity for the WGS reaction.

One-step process. A higher syngas conversion and molar methanol equivalent productivity (MEP), defined in eqn (8),²⁵ can theoretically be achieved in the direct process compared to the two-step process:

$$\text{MEP} = [\text{MeOH}] + 2[\text{DME}] \quad (8)$$

Productivity is improved in the one-step system because *in situ* dehydration of methanol displaces the equilibrium in eqn (1) and (2); hence, methanol yields and, consequently, DME yields increase. Due to the synergy between reactions (1)–(3) and (5), syngas conversion to DME gives higher equilibrium conversions than syngas conversion to methanol.⁷ Industrial feasibility studies have already been carried out,²⁶ where several companies tested a 100 t_(DME) d⁻¹ demonstration plant, which

accomplished a 96% synthesis gas (H₂ : CO = 1.0, derived from natural gas) conversion to DME. However, since the 2006 report of isolated tests, no large scale production of DME by the direct process is taking place.

Improvement of the methanol equivalent productivity by the one-step DME process over the methanol process has also been demonstrated both experimentally (250 °C and 52 bar) and numerically^{25,27} by academic research. However, because a mixture of DME and CO₂ is formed in the one-step process, more downstream separation technologies will be required with this method than with the two-step process because of the high degree of association of the two molecules.²⁸ Concurrent DME and CO₂ separation from unreacted syngas will be necessary if the reactor operates with a H₂ : CO mixture. For example, DME and CO₂ can be removed simultaneously with a scrubbing solvent of methanol and DME;²⁸ subsequently further processing to separate DME from CO₂ and recover the solvent is required. However, DME separation becomes more straightforward if the reactor is able to process CO₂ and hence CO₂ can remain in the recycle loop. Separation of DME alone may be accomplished with water as the scrubbing solvent²³ and a flash separator. Consequently, recovery of DME alone will have a lesser effect on the overall energy efficiency of the process.

It is imperative to quantify the CO₂ output from a given system. For example, in the one-step process the formation of water by reaction (5) results in more CO₂ being produced than consumed. This point is evident in Fig. 3, which shows per-pass conversion of CO₂ and where negative conversion signifies CO₂ formation. CO₂ production increases with the proportion of CO in the system feed. Consequently, operating conditions must be identified where energy efficiency is maximised while CO₂ emissions are minimised. Additionally, CO₂ may be recycled.

A further drawback of the one-step system is that, in practice, catalyst activity may become inhibited by water build-up from



Fig. 3 Equilibrium CO₂ conversion in the direct DME process (no recycle) at 250 °C and 50 bar.



the methanol dehydration process. However, judicious reactor designs have been proposed to mitigate this issue.³¹

In summary, optimum operating conditions are well understood for methanol and DME synthesis systems operating with H₂ and CO in the feed. Hydrogen to carbon monoxide ratios of 2 and 1 are preferred for the methanol/two-step DME synthesis systems and direct DME synthesis system, respectively. Considerably less is known about processes using CO₂ and CO/CO₂ blends instead of CO, especially when CO₂ is introduced into the recycle loop. Hence, the impact of CO₂ on equilibrium yields of methanol and DME was examined in this study, with focus on system performance and CO₂ conversion.

Process assessment methodology

Syngas conversion rates per pass are typically far below equilibrium values and hence the unconverted syngas is separated from the reaction products and recycled back into the reactors for methanol synthesis or direct DME synthesis. In most industrial systems CO₂ is not included in the recycle and is either vented or utilised upstream. However, if the process is to achieve positive net CO₂ conversion then CO₂ could be recycled together with CO and H₂ and hence this separation step is obviated. Whilst recycle would maximise CO₂ conversion, the resultant relative ratios of H₂ : CO₂ : CO in the recycle loop could be significantly different to those in the system feed, which would in turn alter the conversions and yields. Furthermore, the amount of energy contained in the methanol and/or DME product(s) will be offset by the operating energy requirements of multiple system components, such as heat exchangers, compressors and distillation columns. Ultimately, the best system operating conditions will be those at which the energy efficiency is maximised. Hence, the objective of the present study was to include all of the above considerations in the evaluation and comparison of the energy outputs and energy requirements for 4 different systems: methanol synthesis, direct DME synthesis, 2-step DME synthesis with an interposed syngas separation step and 2-step DME synthesis with no separation step between the two reactors. The three DME synthesis schemes are shown in Fig. 4; the methanol synthesis scheme is analogous to that shown in Fig. 4a but without the extra methanol dehydration step.

Equilibrium syngas conversions were computed in Aspen Plus V8.8 using the Peng–Robinson equation of state; reaction-specific scenarios were simulated in the REquill reactor (rigorous equilibrium reactor based on stoichiometric approach) at a fixed temperature of 250 °C and pressure of 50 bar. Results are presented as a function of hydrogen to total carbon molar ratios, H₂ : (CO₂ + CO), in the system feed. The total molar carbon flux : (CO₂ + CO) was fixed, while the CO₂ : CO ratio was varied between 1 and ≈ 0. The relative methanol yields from methanol synthesis were also compared with the methanol equivalent product (MEP), computed using eqn (8), from direct DME synthesis. In these simulations the formation of by-products such as alkanes (methane, ethane, propane and other light hydrocarbons²³), due to <100% catalyst selectivity,²⁹

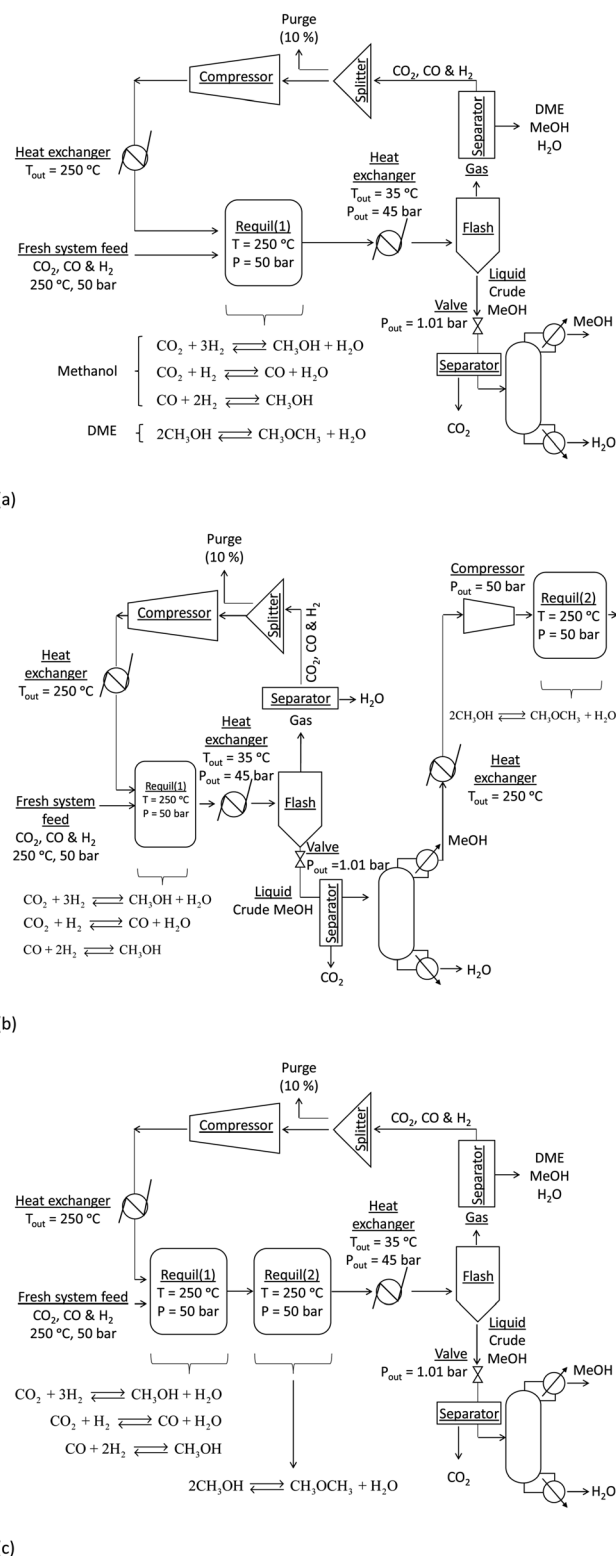

Fig. 4 Schematics of process layouts for direct and indirect DME synthesis from syngas.

was neglected. The methanol and DME yields from the CO and CO₂ molar concentrations in the feed were computed according to eqn (9) and (10), respectively.



$$\eta_{\text{MeOH}} = \frac{[\text{MeOH}]_{\text{out}}}{([\text{CO}_2] + [\text{CO}])_{\text{in}}} \quad (9)$$

$$\eta_{\text{DME}} = \frac{2 \times [\text{DME}]_{\text{out}}}{([\text{CO}_2] + [\text{CO}])_{\text{in}}} \quad (10)$$

System streams

In all systems fresh syngas entered the first reactor pre-heated and pre-pressurized. In the methanol system and in systems (a) and (b) the output streams from the first reactor were cooled in heat exchangers and condensed in flash columns. In system (c) the product stream from the first reactor underwent further conversion in the second reactor before being cooled and passed through a condenser. In system (b) the liquid stream from the flash column containing principally methanol, water and a small molar fraction of CO₂ was expanded to atmospheric pressure in a valve and processed in a distillation column in order to obtain a concentrated liquid methanol stream. The methanol was then re-heated, re-pressurised and dehydrated to DME. In all systems a 5 bar pressure drop in the recycle loops was assumed.³⁰

In all four systems, 90% of the unreacted syngas from the flash column was re-pressurised to 50 bar, re-heated to match the temperature and pressure of the fresh syngas and recirculated back into the first reactor. The remaining 10% was purged to avoid build-up of unreacted gas components. In systems (a) and (b) the DME was removed from the unreacted gases using idealised separators. In practice, DME removal could be achieved using a scrubbing solvent such as water.²³ Energy requirements for this step were not considered explicitly in this study. Neither the separation of the three syngas components from each other to enable the adjustment of their ratios in the recycle loop nor the addition of specific gases to the recycle loop was considered. Hence, the gas ratios in the reactor feed were typically different to those in the system feed.

Reactors

The reactors were assumed to operate under isothermal conditions. In practice the syngas temperature at the inlet is set to be tens of degrees lower than the reactor temperature³¹ because the heat released by the exothermic reactions (1)–(3) and (5) can cause significant and undesirable temperature gradients inside the reactors and result in catalyst deactivation. However, the temperature profiles are highly specific to the convective effects/cooling mechanisms employed in different reactor designs and hence in this study the inlet gas temperatures were matched to the reactor temperatures, resulting in slight overestimation of heater duties.

Energy efficiency analysis

There were three levels in the analyses of system energy requirements: in the first, the heater and compressor energy requirements were met entirely by external means and were associated with additional CO₂ emissions; in the second, the pre-flash column heat exchangers were coupled with the recycle loop heat exchangers *via* a water stream to generate an energy

saving; finally, combustion of the H₂ and CO gases in the purge stream to meet a fraction of the compressor and heat exchanger energy requirements was considered as an option. The complete conversion of the purged H₂ and CO to either heat or electrical energy was assumed to allow the utilisation of *ca.* 60% of the combustion energy, based on their respective lower heating values (237 kJ mol⁻¹ for H₂ and 283 kJ mol⁻¹ for CO³²). These additional considerations are shown schematically in Fig. 5.

Compressors, pumps, heat exchangers and distillation columns

The gas compressors were assumed to operate with an isentropic efficiency of 90% and a mechanical efficiency of 90%. The water stream by which the heat exchangers were coupled had initial temperature and pressure of 20 °C and 1 atmosphere respectively, and was pressurized with a pump assumed to operate with 70% energy efficiency to 40 bar prior to entry into the first heat exchanger. This water stream was constrained to a liquid state ($T_{\text{sat}} = 250$ °C at 40 bar) at all stages. Additional heat exchangers were added to the recycle loop to ensure the recycled gas stream was pre-heated to 250 °C, prior to re-entry into the first reactor.

DSTWU distillation columns in Aspen Plus, utilising Gilliland's, Winn's, and Underwood's methods were used to model methanol separation from water by computing the required number of stages and reflux ratios for each scenario. Idealised separators were employed for removing CO₂ and any minute fractions of CO and H₂ from the liquid crude methanol stream prior to entry into the distillation units.

Not taken into account were the energy requirement and CO₂ emissions associated with the supply of the air/O₂ that would be required to support CO and H₂ combustion. Furthermore, the

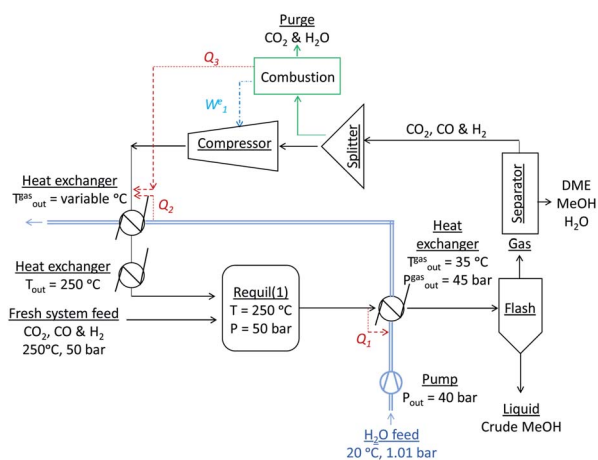

Fig. 5 Schematic illustration of the two simulated energy saving methods in a given recycle loop. In the first energy saving method, heat is recovered from the post-reactor gas stream by a cold pressurised water stream and subsequently delivered to the cold gas stream in the recycle loop. In the second energy saving method the purged H₂ and CO gases are combusted and a fraction of the energy is recovered as heat and/or work and delivered to the heat exchanger and compressor, respectively, in the recycle loop.



energy required to pressurise and heat the fresh feed gases to the system were not included and are part of a separate analysis that addresses the mechanisms of syngas production.

CO₂ emissions

The power demand and CO₂ emissions associated with the heat exchangers as well as with the compressors, the water pump and the reboiler and condenser in the distillation columns were computed and taken into account in the energy balance, assuming emissions of 5.4 kg(CO₂) GJ⁻¹.³³ In practice, the gases can either undergo homogenous combustion, for which the combustion temperature would need to exceed the auto-ignition temperatures of both H₂ (500 °C) and CO (609 °C)³⁴ or alternatively direct conversion to electrical energy in fuel cells. CO₂ emissions resulting from complete combustion of the purged CO have also been taken into account; combustion of H₂ does not generate CO₂ as the product is only water vapour.

Results and discussion

Equilibrium yields without recycle

Although calculations for equilibrium yields have been performed previously for both methanol and DME synthesis,²⁵ and are conclusive about the optimum molar proportions of H₂ and CO in the reactor feed, it is beneficial to perform these calculations with the additional inclusion of CO₂ in order to understand the different choices of feed compositions used industrially, especially where CO₂ is the principal source of carbon. Hence, initially the per-pass equilibrium yields of methanol and DME, their molar fractions in the reactor product streams, the extents of H₂, CO₂ and CO conversion, as well as the molar fractions of the water by-product are shown in Fig. 1S–4S in the (ESI†).

Fig. 1S(a)† shows that in the case of methanol synthesis, the process output is much more sensitive to the H₂ : CO ratio than it is to the H₂ : CO₂ ratio. As shown previously,²⁵ a process utilising principally H₂ and CO in the feed exhibits optimum performance in terms of the methanol molar fraction in the product stream at the stoichiometric H₂ : CO ratio of ≈ 2. At higher H₂ to carbon ratios, the conversion of CO₂ and CO to methanol continues to increase with a decreasing slope (sub-Fig. 1S(c) and (d)†), but at the expense of lower hydrogen conversion (Fig. 1S(e)†). Hence, the choice of whether to operate under hydrogen rich conditions will be dictated by the cost of hydrogen production and energy consumption of methanol separation. However, hydrogen-rich conditions can promote the formation of water, especially when CO₂ is the main source of carbon, and this places significant constraints on the choice of catalyst. Water production by the reverse water gas shift reaction increases substantially with CO₂ fraction in the syngas feed, passing through a maximum at H₂ : CO₂ of approximately 2, but subsequently decreasing (Fig. 1S(f)†). The decay in the molar fraction of the water by-product under hydrogen rich conditions for a H₂–CO₂ feed justifies the choice of higher H₂ : CO₂ ratios employed industrially.^{11,13} Consequently, for systems utilising primarily CO and H₂, stoichiometric feed compositions give the optimum yield, while for systems using

primarily CO₂ and H₂, higher CO₂ conversion can be achieved under hydrogen-rich conditions, provided the hydrogen can be sourced sufficiently cheaply and the chosen catalyst can tolerate water build-up. However, even if CO₂ is the sole source of carbon in the system feed, in the presence of a recycle loop, a certain quantity of carbon monoxide will be present in the reactor feed as it is formed *via* the reverse water gas shift reaction in parallel with methanol synthesis.

If methanol dehydration can proceed simultaneously with CO₂ and CO hydrogenation, the methanol equivalent product (MEP) is greater than in the case of methanol, as shown in Fig. 6. The advantage is especially apparent when H₂ : (CO₂ + CO) < 1. However, for the various CO₂ : CO ratios it is apparent that the greatest advantage of the additional dehydration step can be gained when CO₂ is the principal source of carbon. For a syngas feed without CO₂, the maximum DME molar fraction in the product is found at a H₂ : CO ratio of 1, which corresponds to a more carbon rich regime relative to methanol alone (Fig. 2S(a)) in the (ESI†). Under this condition, the build-up of water is minimised by the water gas shift reaction but at the expense of carbon dioxide formation, as is evident from Fig. 2S(c).† Hence, if the CO in the syngas is produced from CO₂ in Stage 1 (Fig. 1), then it would be impractical to reverse the benefits of further conversion to fuel in Stage 2 by selecting conditions that would re-generate the CO₂ to the greatest degree. Fig. 7 shows the extents of CO to CO₂ conversion in the methanol and direct DME processes when a H₂–CO only feed is used, illustrating the undesirable impact of the water gas shift process that takes place as a result of H₂O formation from *in situ* methanol dehydration. Hence, operation with a H₂–CO feed is unsuitable in the absence of CO₂ recycle.

Unsurprisingly, the extents of CO and H₂ conversion in direct DME synthesis also change very significantly relative to the case of methanol production; the increase in both is shown in Fig. 2S(d) and (e).† Water build-up increases dramatically in

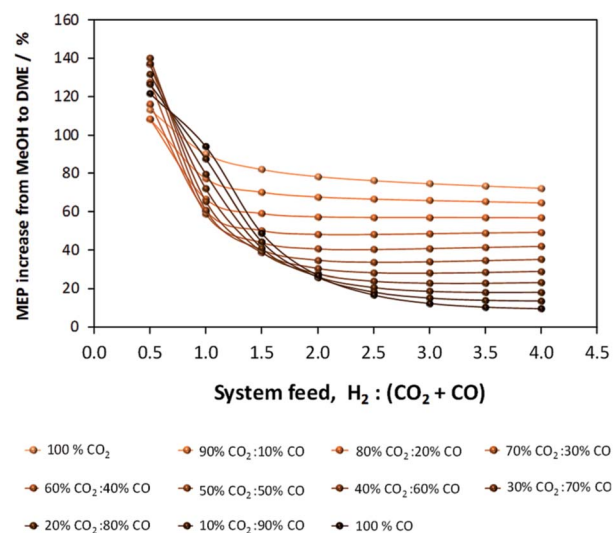

Fig. 6 MEP increase of the direct DME process relative to methanol alone; calculations based on reactor outputs at 250 °C and 50 bar in the absence of recycle.



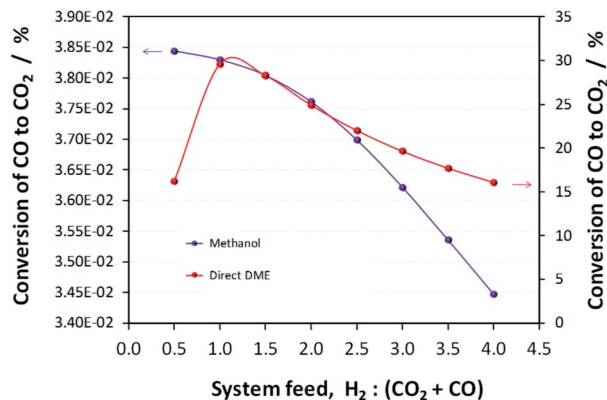

Fig. 7 Extents of CO conversion to CO₂ via the water gas shift reaction during methanol and direct DME synthesis when a H₂-CO only feed was employed.

the direct DME synthesis process relative to the methanol process (Fig. 2S(f)†) and this is thought to be the principal reason why the direct synthesis of DME is not yet deployed industrially. Once catalysts able to survive water build-up are developed then direct utilisation of CO₂ rather than CO is preferable if the direct DME synthesis is to simultaneously fulfil the requirements of achieving net negative CO₂ emissions and higher MEP relative to methanol synthesis alone.

Two principal disadvantages of direct DME synthesis, namely the net negative CO₂ conversion over a wide range of syngas compositions and also the ultimate need to separate DME from CO₂, which are strongly associating, can be overcome if the 2-step synthesis is employed. However, because the two-step process does not utilise the synergy between the CO₂ and CO hydrogenation processes and the methanol dehydration process, the MEP will not improve relative to methanol synthesis alone. Fig. 3S and 4S in the ESI† show results corresponding to two possible scenarios for the two-step process: in the first scenario, the unreacted syngas (H₂, CO₂ and CO) from the methanol reactor is cooled and separated from the product stream in a condenser; the crude liquid methanol undergoes distillation and the isolated methanol stream then undergoes further processing in the DME reactor (Fig. 3S†). In the second scenario the product stream from the methanol reactor is fed directly into the DME reactor without any processing and it is assumed that only the methanol dehydration, unaccompanied by the WGS reaction, can occur in the second reactor (Fig. 4S); it was assumed explicitly that the rate of the WGS process is nil or negligible on methanol dehydration catalysts, for example when using γ -Al₂O₃ as catalyst at 250 °C.

The principal conclusion from the comparison of the two-step systems is that in terms of thermodynamics, there is no added benefit in isolating the water and unreacted syngas from the methanol before it undergoes dehydration to DME in the second reactor. This is because at 250 °C the equilibrium yield of DME from methanol is virtually independent of pressure. Hence, although the partial pressure of methanol is much lower in the absence of a separation step, the conversion is not affected. But again, in reality the kinetics may be affected by the

strong difference in partial pressure between the two systems. The DME yield was marginally lower in the 'separated' case due to the efficiency of liquid methanol separation in the condenser. In conclusion, the choice of process will depend on the relative energy demands of the extra distillation and re-heating steps in the separated case and with DME separation from CO₂ in the non-separated case.

Methanol and DME synthesis systems analysis

Results presented in Fig. 6, 7 and 1S–4S in the ESI† differ dramatically once a recycle loop is introduced and energy demands for various different system components are accounted for. Fig. 8 shows the overall efficiencies for the methanol synthesis system for two extreme cases: (a) a H₂-CO only feed and (b) a H₂-CO₂ only feed. Net energy outputs were computed as the energies extracted in the form of methanol and corrected by the energy demands for system operation and energies lost in unreacted H₂ and CO gases that were vented. These outputs were normalised by the total energies contained in the H₂ and CO feeds to the systems. Worst case scenarios in both cases correspond to situations where no energy saving mechanisms were employed; the best case (theoretical only) scenarios show only the energy contained in the methanol, assuming the syngas conversion systems require no additional energy to operate. Three intermediate cases show the net energy outputs when heat exchangers were coupled, when the vented gases were used for heat/power production and when both of these energy saving mechanisms were employed together. Fig. 8(c) and (d) show the corresponding contributions of these energy saving methods for the H₂-CO and H₂-CO₂ scenarios.

Methanol production with a H₂-CO only feed shows the predictable peak in performance at a system feed H₂ : CO ratio of 2.0. At this ratio, the system requires minimal energy savings and the point of optimal performance is affected only marginally by the improvements to the energy efficiency. In terms of energy savings, across the entire H₂ : CO range greater energy savings were obtained by combusting the vented unreacted H₂ and CO₂; hence this approach is essential.

In the absence of energy savings, the optimum operating point for the H₂-CO₂ system lies at a H₂ : CO₂ ratio of 2.5, which, interestingly, is not the stoichiometric ratio of reaction (2). The peak, however, is much broader than in the H₂-CO case and the acceptable operating range is arguably between H₂ : CO₂ feed ratios of 2.0–3.0. The H₂ : CO₂ ratio of highest net energy production remained unchanged regardless of which energy saving mechanisms were employed. The slopes of the curves are markedly different to those for the H₂-CO case, especially at hydrogen-rich conditions, and show the greater tolerance of H₂-CO₂ system to different feed gas ratios.

The optimum operating range evident from Fig. 8b is not in agreement with the preferred H₂ : CO₂ feed ratios of 5.0 and 3.5, specified in ref. 11 and 13, respectively. It is possible that if hydrogen was sourced renewably, then limiting the H₂ fraction in the feed was less important. The molar fractional water content in the reactor is only marginally lower at H₂ : CO₂ of 3.5 (0.058) than at 2.5 (0.062) and so the reasons for the use of



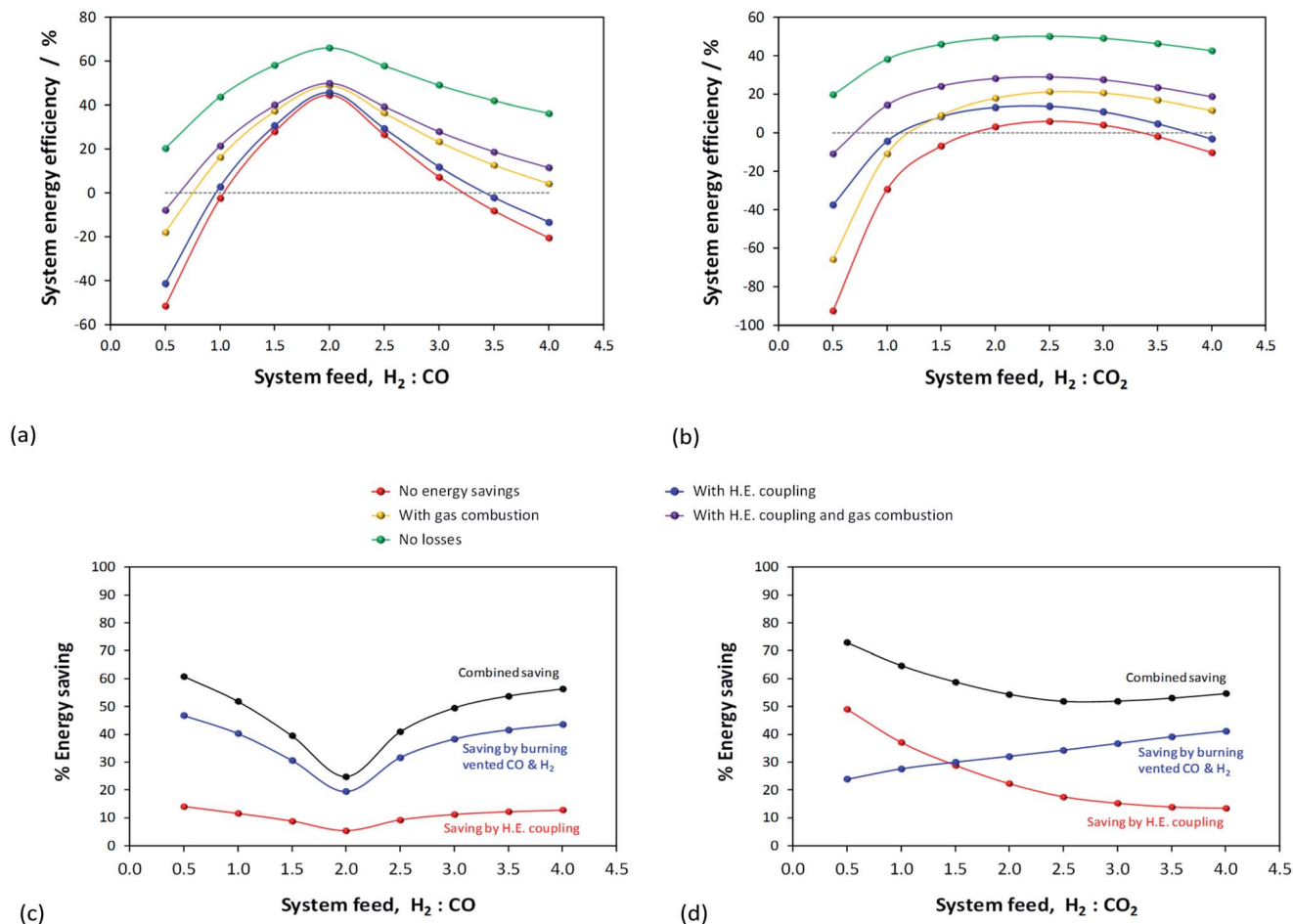

Fig. 8 Efficiencies for the methanol synthesis system for two extreme cases: (a) a H_2 -CO only feed and (b) a H_2 -CO₂ only feed. The 'no losses' scenario is a theoretical-only case in which the syngas conversion process consumes no energy and vented gases do not constitute energy loss. The corresponding energy savings made by coupling heat exchangers and by combustion of vented gases are shown in (c) and (d).

higher H_2 mole fractions are probably rather related to kinetics. Finally, Fig. 8b and (d) demonstrate that, for a H_2 -CO₂ feed, both energy saving methods are necessary to achieve a positive net energy output and to improve the system efficiency.

Fig. 5S in the ESI[†] shows the optimised net energy output curves for (a) the methanol, (b) direct DME, (c) 2-step DME synthesis with an interposed syngas separation step and (d) 2-step DME synthesis with no separation step between the two reactors. For each scenario, curves for a H_2 -CO only, H_2 -CO₂ only and H_2 (50% CO : 50% CO₂) system feeds are presented. In all the cases where methanol is produced in the first step, the optimum operating point lies between $H_2 : C$ ratios of 2.0–2.5, being higher for syngas system feeds with more CO₂ content. The optimum point for the direct DME synthesis is at a ratio of 1.0 for the H_2 -CO case, but the breadth of the peak allows for high efficiency operation between ratios of 1.0–2.0. For the H_2 -CO₂ feed in the direct DME case the peak is again at the feed ratio of 2.5. Interestingly, the 50 : 50 CO₂ : CO cases exhibited considerably higher efficiencies at CO₂/CO-rich conditions compared with the other two feed compositions.

Table 1 shows the peak energy efficiencies that have been computed for each system both in the absence and presence of

energy saving procedures. These maxima are evident in Fig. 9, where the net energies obtained in the four processes are compared directly. The highest efficiencies were obtained for H_2 -CO only feeds in the direct DME system and the 2-step DME system where there was no processing step between the two reactors. The poorer performance of the methanol system and the 2-step DME system in which crude methanol is isolated from the unreacted syngas and distilled before being dehydrated, is in part due to the poor efficiency of the methanol condensation stage. The fraction of the methanol extracted in liquid form is especially low under CO/CO₂-rich conditions, as shown in Fig. 6S in the ESI.[†] The fraction of DME recovered from the flash column in gaseous form, however, is considerably higher at over 99.8% across the whole $H_2 : C$ range, as shown in Fig. 7S.[†] Furthermore, the 2-step system with separation has additional energy demands for reheating and re-compressing the methanol and for this reason exhibits the poorest performance.

It should be noted that the penalties in terms of the energy demands for DME recovery from syngas and the resultant decreases in efficiency were not included in the analysis. In practice, DME can be removed by exposure of the gaseous



Table 1 The efficiencies of systems operating without and with maximum energy savings for three feed compositions: 100% CO₂, 100% CO and 50% CO₂ : 50% CO. The net energy outputs of each system were normalised against the energies contained in the CO and H₂ gases in the system feeds

| System feed | Maximum energy efficiency/% | | | | | | | |
|-----------------------------|---|------------|----------------------------|-------------------------------|-----------------------------|------------|----------------------------|-------------------------------|
| | Without energy savings | | | | With maximum energy savings | | | |
| | Methanol | Direct DME | 2-Step DME with separation | 2-Step DME without separation | Methanol | Direct DME | 2-Step DME with separation | 2-Step DME without separation |
| 100% CO | 44.6 | 63.3 | 34.6 | 60.4 | 49.9 | 69.2 | 44.6 | 65.7 |
| 50% CO: 50% CO ₂ | 23.7 | 50.6 | 14.9 | 35.7 | 39.2 | 60.6 | 34.7 | 51.6 |
| 100% CO ₂ | 6.11 | 39.4 | -2.4 | 17.4 | 29.0 | 53.0 | 24.4 | 40.5 |
| | Difference in energy efficiency obtained with CO-only feeds and CO ₂ -only feeds/% | | | | | | | |
| | 38.5 | 23.9 | 37.0 | 43.0 | 21.0 | 16.2 | 20.2 | 25.2 |

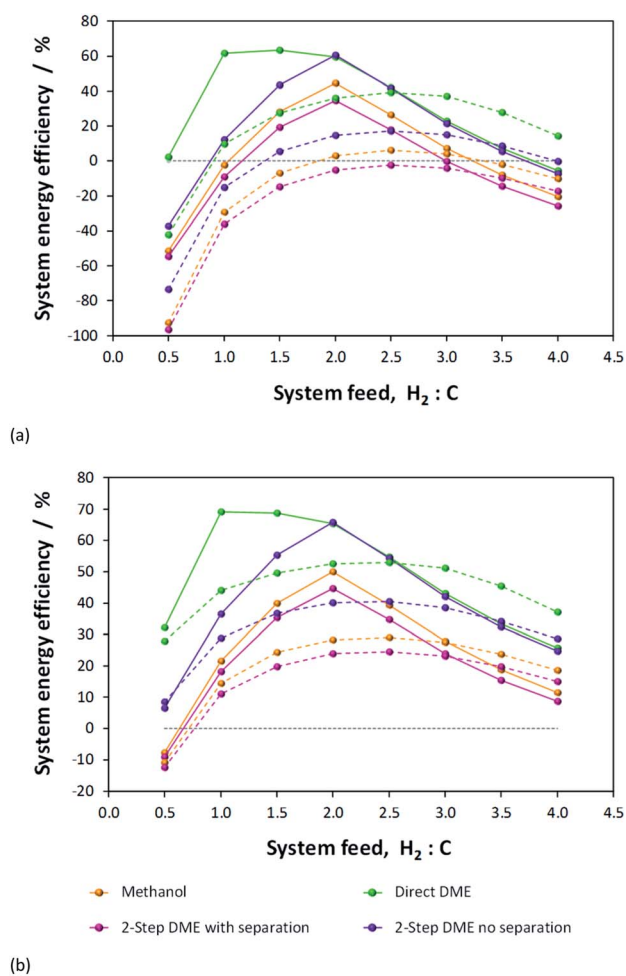

Fig. 9 Net energies obtained with (a) no energy savings and (b) maximum savings with the H₂-CO only (solid lines) and H₂-CO₂ only (dashed lines) system feeds for the four systems under investigation.

output from the flash column to a water stream in which DME is soluble.²³ The water scrubbing fluid would be at a temperature in the range 1–20 °C and at a similar pressure to that at which DME synthesis is carried out. Subsequently, DME could be separated from water at reduced pressure in a flash column.

The goal of the present study was to identify the best system for either directly processing CO₂ or indirectly resulting in a positive net CO₂ conversion. The best system for the direct conversion of CO₂ will be the one for which the net energy output with a H₂-CO₂ only feed matches most closely the net energy output with a H₂-CO only feed, as for each system the latter case always gives the highest syngas conversion. In the absence and presence of performance optimisation, the best direct utilisation for CO₂ is in the direct DME process. Thermodynamic calculations show that at equilibrium conversion the difference in energy efficiencies between H₂-CO and H₂-CO₂ systems was 23.9% and 16.2%, respectively. The peak efficiencies and corresponding differences between H₂-CO and H₂-CO₂ cases were substantially greater for the other three systems.

In terms of performance, the next best system to 1-step DME was the two-step DME synthesis with direct transfer of methanol and unreacted syngas to the DME reactor. System analysis yielded considerably better results than for an analogous system in which crude methanol was separated from the unreacted syngas and distilled before being dehydrated to DME before. The latter suffered from the efficiency of liquid methanol extraction from the flash column and the extra energy requirements for reheating and recompressing concentrated methanol before the DME reactor. However, we again note that this difference is not likely to be reflected in the kinetics, which will be superior when methanol is not diluted by water or unreacted syngas; water especially would shift the equilibrium in reaction (5) unfavourably towards methanol. Furthermore, the 2-step DME system with an interposed methanol isolation stage could potentially have a higher overall energy conversion efficiency as it liberates the greatest amount of heat from methanol/DME syntheses, as shown in Fig. 8S in the ESI,[†] which would contribute to energy savings upstream.

A comparison of MEP values between the direct DME process and the methanol process in the presence of their respective recycle loops is presented in Fig. 10. When these curves are compared with those of Fig. 6 where a recycle loop was not employed, it is clear that the act of recycling alters the H₂ : CO : CO₂ ratios relative to those in the system feed so as to



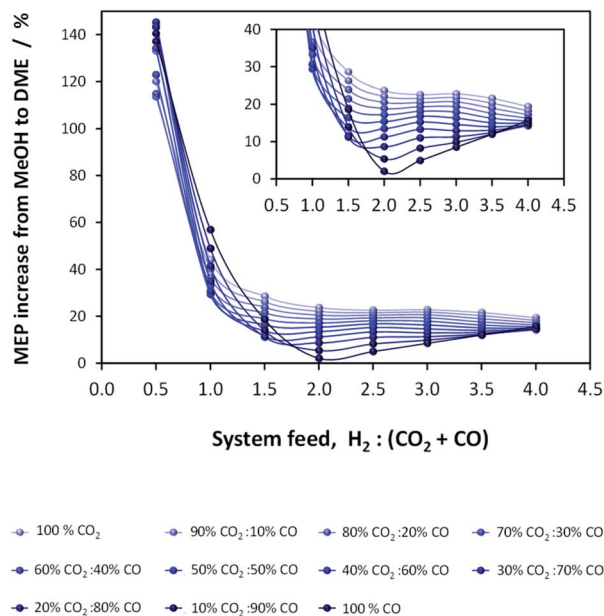

Fig. 10 MEP increase of the direct DME process relative to methanol alone; calculations based on system outputs (post flash separation and distillation processes etc.).

inhibit system performance for the direct DME case. This is due to the formation and build-up of CO_2 via the water gas shift reaction between CO and the H_2O that is formed during methanol dehydration. It is for this reason that such relatively high performance with H_2 - CO_2 only feeds can be achieved. The large build-up of CO_2 with a H_2 -CO feed in the direct DME process relative to the other systems is confirmed in Fig. 11, where the CO : CO_2 ratio in the recycle loop is in the range 0.6–25, despite the ratio being 260 000 in the system feed (we note that for a ' H_2 : CO-only' system, a small molar fraction of CO_2 was fed into the system together with CO in order to prevent excessive CO_2 build-up). The differences in the ratios for the other systems are due to variances in the separation efficiencies of CO_2 as gas in the flash column.

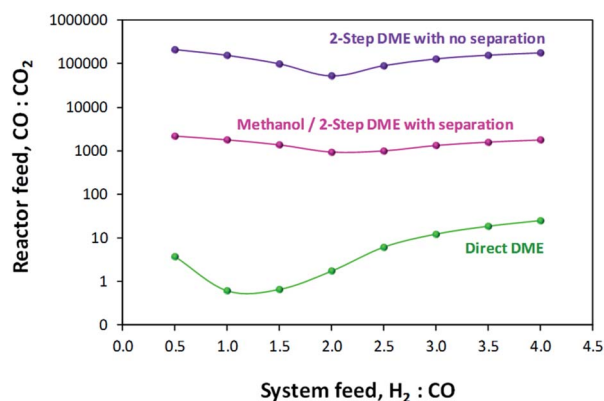

Fig. 11 CO : CO_2 ratios in the recycle loops for the methanol/DME synthesis systems, fed only with H_2 and CO.

In principle, all or part of the CO_2 in the recycle loop can be removed simultaneously with DME using a scrubbing solvent, such as a mixture of methanol and DME.²⁸ However, subsequently several stages to separate the DME from the CO_2 and also to recycle the scrubbing solvent will be required. The CO_2 will also need to be recycled upstream of the reactor in order not to be emitted to the atmosphere. Alternatively, the CO_2 and DME could be condensed out of the gaseous mixture.²⁹ However, the combined CO_2 /DME removal and separation process will certainly result in a substantial efficiency penalty.

CO_2 emissions were computed for the methanol/DME synthesis systems and included contributions from: CO_2 emitted directly in the vented gases, additional CO_2 emitted in the vented gases as a result of complete CO combustion in the energy saving scheme, CO_2 contained in the crude methanol streams from the flash columns and CO_2 emitted to power the process components, where the energy requirements were not met by the combustion of vented CO and H_2 . Results are shown in Fig. 12 and demonstrate that, unlike in the single pass scenario, CO_2 emissions are minimal in the direct DME synthesis system.

Fig. 12 shows that the presence of a recycle loop minimised the emissions of CO_2 , which would otherwise have been very significant in the direct DME synthesis system operating with CO. In fact, CO_2 emissions were greater for all systems utilising H_2 - CO_2 only feeds due to the lower product yields (relative to H_2 -CO feeds) and the greater amounts of energy required to run the systems and maintain large amounts of unreacted gases in the recycle loops.

In summary, according to thermodynamic equilibrium calculations and system analysis, when CO_2 is utilised as the principal source of carbon, the highest net energy outputs were achieved with the direct DME synthesis system. This system also demonstrated the highest overall performance with CO, albeit the MEP is reduced significantly by the large build-up of

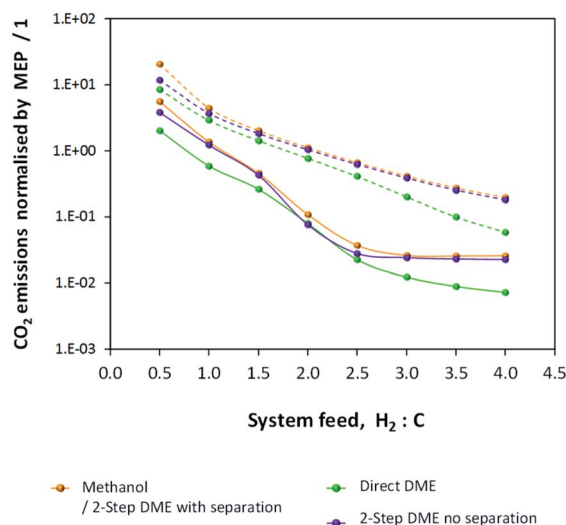

Fig. 12 CO_2 emissions normalised by the MEP for the methanol/DME production systems employing H_2 -CO only (solid lines) and H_2 - CO_2 only (dashed lines) feeds.



CO₂ in the recycle loop due the water gas shift reaction between CO and the water generated by *in situ* methanol dehydration. Performance with CO₂ as the carbon source can theoretically be lower than the performance with CO by only 16.2%, provided energy saving strategies such as coupling of heat exchangers and the combustion of vented CO and H₂ to generate thermal and electrical energies are employed. Hence, direct utilisation of CO₂ is preferable in the direct DME system rather than in systems producing only methanol in the first stage. This system also achieves the highest degree of CO₂ conversion.

Conversion of CO₂ to CO upstream of the DME system that appears necessary for systems where methanol is produced in the first stage, would not be beneficial if the increase in the net energy yields are balanced or even outweighed by the energy requirements of this additional step. Upstream syngas production needs to be analysed with two points in mind. Firstly, based on the findings in this study, direct utilisation of CO₂ requires at least 1.25 times more hydrogen in the system feed than when CO is used and this would result in additional penalties both in terms of energy requirement and CO₂ emissions. Secondly, the heat liberated by reactions (1)–(3) and (5) in the methanol/DME reactors, and extracted in order to maintain isothermal conditions can be recovered and used to support upstream processes for generating H₂ and CO from H₂O and CO₂. Fig. 8S in the ESI† shows the heats liberated in the methanol and DME synthesis reactors under consideration in this study. More heat is liberated by CO dehydration than by CO₂ dehydration. Hence, again, the benefits of a H₂–CO only syngas could potentially be reversed if the upstream processes for converting CO₂ and H₂O to CO and H₂ require substantially greater energy inputs than energy recoverable from the downstream reaction heat.

Hence, the criterion for directing the decision of whether to use CO₂ or CO (produced upstream from CO₂) as the principal sources of carbon in the feed for methanol/DME syntheses is that the value of ‘net energy gain from using CO instead of CO₂ in methanol/DME syntheses’ is greater than the ‘energy required to generate syngas of the required composition’, with account taken for heat recoverable from downstream exothermic processes. An additional criterion is that the CO₂ liberated to support the running of the systems must be only a small fraction of the CO₂ utilised. Naturally, the decision would also be dictated by availability of catalysts able to support direct CO₂ conversion to methanol, although as evidenced from ref. 11–13 this can already be carried out at industrial scale.

Syngas production from CO₂ and H₂O

With decontaminated H₂O and CO₂ as the building blocks, syngas may be produced electrochemically and/or *via* the WGS/RWGS reactions (3) using a variety of means depicted in Fig. 13. Hydrogen may be generated by the reduction of water in an electrolyser *via* reaction (11). The most commonly used device on an industrial scale is an alkaline electrolyser, which is typically operated at elevated temperatures in the range 60–90 °C and can also be performed at pressures up to 700 bar. Usually these devices operate with an energy efficiency of up to 70% and a faradaic efficiency close to unity.



A typical specific electrical energy consumption for alkaline water electrolysis at atmospheric pressure and at 75 °C without account of parasitic energy losses or gas losses is *ca.* 4.5 kW h Nm(H₂)⁻³ ≈ 100 kW h kmol(H₂)⁻¹.³⁵

Hydrogen produced by electrolysis may be utilised directly as shown in schemes (a)–(c) and (e) in Fig. 13 and/or reacted with CO₂ *via* the RWGS process shown in (b) to generate a mixture of CO, H₂O, CO₂ and H₂, from which CO and H₂ can then be isolated and fed into the methanol/DME reactors. Schemes (a), in which a CO₂-based syngas is generated, and (b), in which a CO-based syngas is generated, are based on readily available technologies with well-characterised performance.

In an alternative scheme to (b), CO may be produced directly by CO₂ reduction using a technology that is still currently in the research phase: solid oxide electrolysis.³⁶ During the reduction reaction (12), CO₂ is split into CO and oxide ions; the oxide ions migrate across a solid oxide electrolyte and become oxidised to oxygen gas. The net system reaction is shown in eqn (13). This process takes place at elevated temperatures (typically 500–800 °C), which are required to achieve a sufficient conductivity in the solid oxide electrolyte. CO produced in this way may be reacted directly with H₂ to form methanol/DME *etc.*, as shown in scheme (c) or reacted with water vapour *via* the WGS process to generate a mixture of H₂, CO₂, H₂O and CO, as shown in scheme (f). Although this technology is still very much under development, CO₂ electrolysis in solid oxide systems is already being carried out industrially, for example by Haldor Topsoe.³⁷

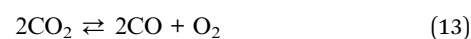
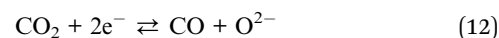

The specific electrical energy consumption for the production of CO *via* high temperature electrolysis of CO₂ is reported to be of order 2.1 kW h kg(CO₂)⁻¹ (ref. 36) at 800 °C and 1 atm., corresponding to ≈ 92 kW h kmol(CO)⁻¹.

High temperature CO₂ electrolysis is reported to be more efficient if it is carried out simultaneously with the reduction of steam as per reaction (14), in a process termed co-electrolysis.³⁸ This process has two principal advantages over the scheme in (13) firstly because CO₂ reduction is aided by the RWGS process that takes place as H₂ is formed and secondly because it suppresses the formation of solid carbon.

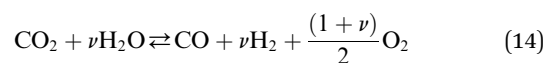

The H₂ : CO ratio in the resultant syngas is controlled by the H₂O : CO₂ ratio in the feed.³⁹ For example, the specific electrical energy consumption for co-electrolysis at 800 °C and 1 atm. generating syngas with a molar ratio of H₂ : CO = 2.0 is estimated at 3.2 kW h Nm_{syngas}⁻³. Co-electrolysis can be used as a standalone process to generate a H₂–CO syngas as shown in



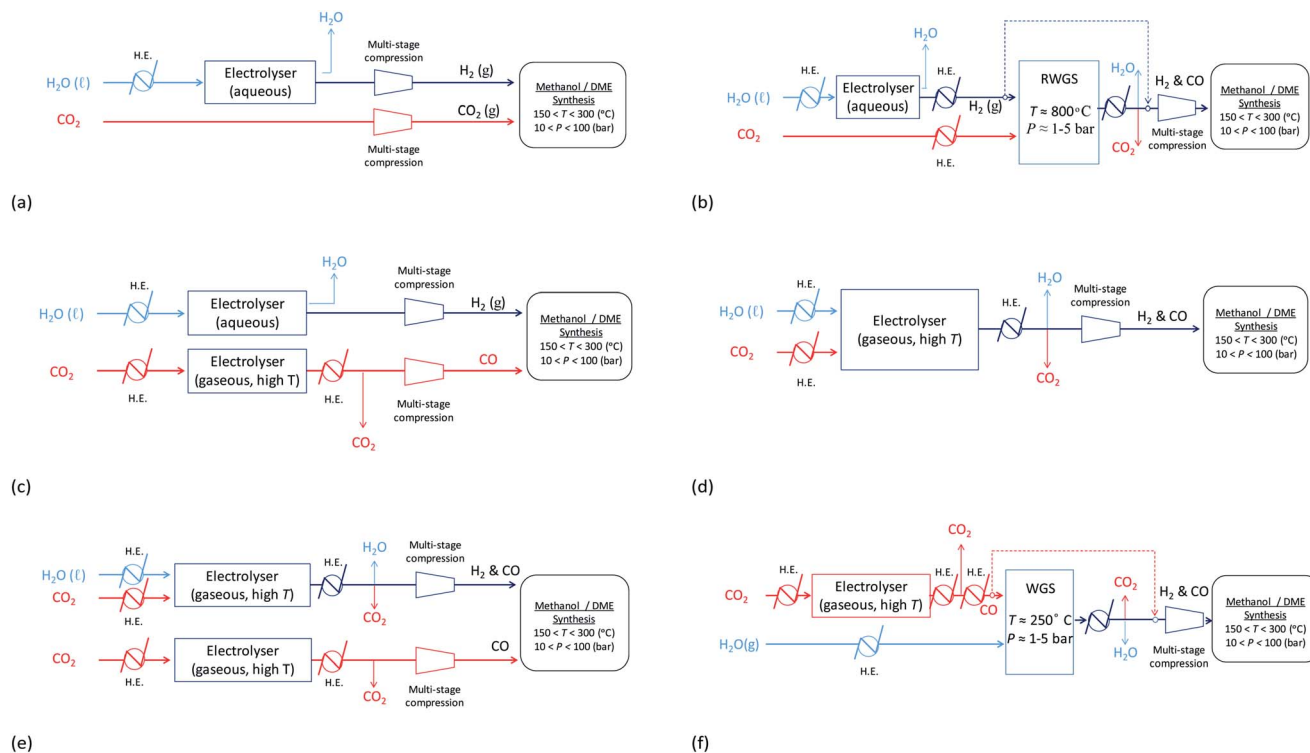

Fig. 13 Possible routes for the production of syngas, with varying ratios of H_2 : C, from H_2O and CO_2 .

scheme (d), or performed in parallel with CO_2 electrolysis as in scheme (e) if the H_2 –CO ratio requires adjustment.

The energy requirements of schemes (a)–(f) in Fig. 13 were evaluated based on the specific electrical energy consumptions for alkaline electrolysis (75 °C, 1 atm.), CO_2 electrolysis (800 °C, 1 atm.) and CO_2 – H_2O co-electrolysis (800 °C, 1 atm.) specified in ref. ^{35, 36 and 39}, respectively, and simulations of the RWGS/WGS processes, as well as energy demands of heat exchangers and compressors relevant to each scheme, in Aspen Plus V8.8.

Stage 1 energy consumptions were used to determine the differences between normalised energies required to produce CO_2 -based syngas (scheme in Fig. 13a) with the optimum H_2 : CO_2 ratio of 2.5 for both methanol and DME syntheses and CO-based syngas with H_2 : CO ratios of 2 and 1 for methanol and direct DME processes, respectively (schemes (b)–(f)). These differences are shown in Fig. 14, where they are compared with the normalised energy gains in Stage 2 that were achieved when a CO-based rather than CO_2 -based syngas was used in the production of methanol (Fig. 14a) and DME by the direct process (Fig. 14b). Results show that in the case of methanol synthesis, the benefits of a CO-based feed in Stage 2 always outweigh any additional energy requirements in Stage 1, regardless of which syngas production scheme was employed. Furthermore, when schemes (c) and (e) were used to produce CO-based syngas, less energy was consumed than in the production of hydrogen in scheme (a). Scheme (e) appears to be the best for producing syngas with the correct ratios for both methanol and DME synthesis, although it should be noted that the specific electrical energy consumption used in assessment of schemes (d) and (e)³⁹ was not determined experimentally,

unlike in the other schemes. Hence, further validation may be necessary. In the case of DME production, scheme (b) generated the worst case scenario, which showed that losses in Stage 1 were greater than gains in Stage 2.

As well as energy consumption, the combined CO_2 utilisation/emissions associated with Stages 1 and 2 are of critical importance in identifying the best system for CO_2 conversion to fuels. The CO_2 consumed (by conversion to CO) and liberated (to support process energy demands) was computed for each Stage 1 scheme in Fig. 13; the net differences were normalised against the energies contained in the final syngas products, as shown in eqn (15). This enabled the comparison of net CO_2 consumption in Stage 1 (negative for schemes (b)–(f) and positive for scheme (a)) with CO_2 emissions in Stage 2, evaluated using eqn (16).

$$\text{Stage 1: } CO_{2(\text{emitted})} = \frac{CO_{2(\text{emitted})} - CO_{2(\text{consumed})}}{(E_{\text{syngas}})_{\text{out}}} \quad (15)$$

$$\text{Stage 2: } CO_{2(\text{utilised})} = \frac{CO_{2(\text{vented})} - CO_{2(\text{in})}}{(E_{\text{syngas}})_{\text{in}}} \quad (16)$$

When CO_2 was converted to CO upstream of the methanol/DME reactors (schemes (b)–(f) in Fig. 13), net CO_2 utilisation was achieved in Stage 1, whereas direct use of CO_2 in the methanol/DME reactors (scheme (a)) resulted in net CO_2 utilisation in Stage 2. Fig. 15 shows a comparison of the relative CO_2 utilisation and emissions, both normalised by the energy contained in the syngas, in Stages 1 and 2 of systems producing methanol and DME *via* the direct process. The direct DME



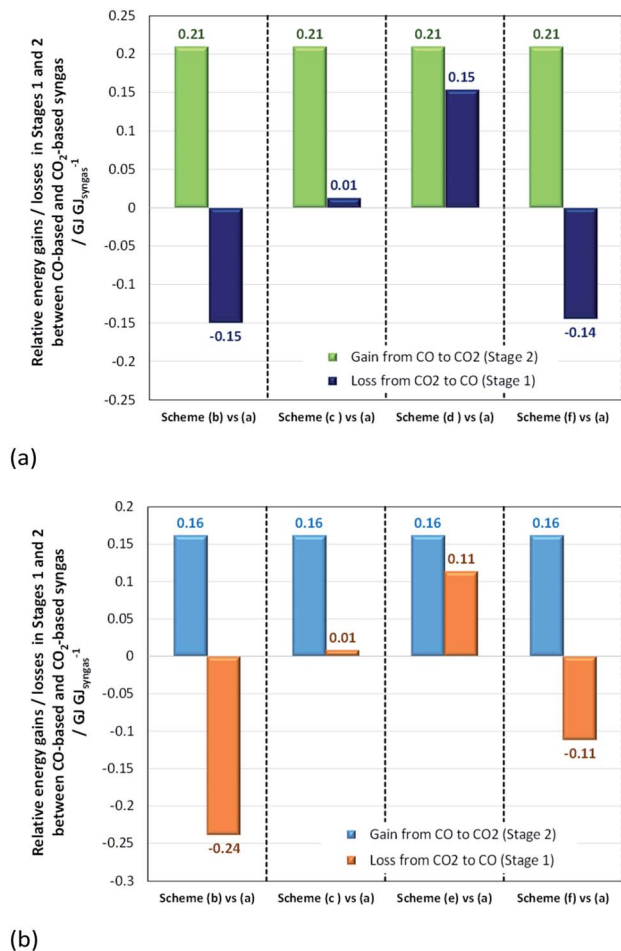

Fig. 14 Relative normalised energy losses in Stage 1 and gains in Stage 2 when (a) methanol and (b) direct DME systems are operated with CO-based and CO₂-based syngas.

process was modelled to utilise CO₂-based syngas directly (produced in scheme (a) in Fig. 13) with the optimum H₂ : CO₂ ratio of 2.5 identified earlier and also CO-based syngas produced in schemes (b), (c), (e) and (f) with H₂ : CO = 1. Due to the poor performance of the methanol and 2-step DME systems with CO₂ in the feed, the methanol system was modelled with a CO-based syngas only, using schemes (b), (c), (d) and (f) with H₂ : CO = 2.

The results presented in Fig. 15 show that while the production of syngas with H₂ : CO ratio of 1 in Stage 1, tailored for direct DME synthesis, leads to the highest CO₂ utilisation, the benefits are offset substantially by the generation of CO₂ by the water gas shift reaction in Stage 2. For all the schemes considered, it has been calculated that between 50–54% of CO₂ consumed in Stage 1 is regenerated in Stage 2. The extent of CO₂ regeneration is reduced to 48% if direct DME synthesis is performed with CO₂ rather than CO, thereby confirming that direct utilisation of CO₂ is possible and thermodynamically preferable with this process.

Results in Fig. 15 show unambiguously that if CO₂ is converted to CO in Stage 1, then it is substantially better to use this CO for the production of methanol (or DME *via* the two-step routes) rather than DME *via* the direct route.

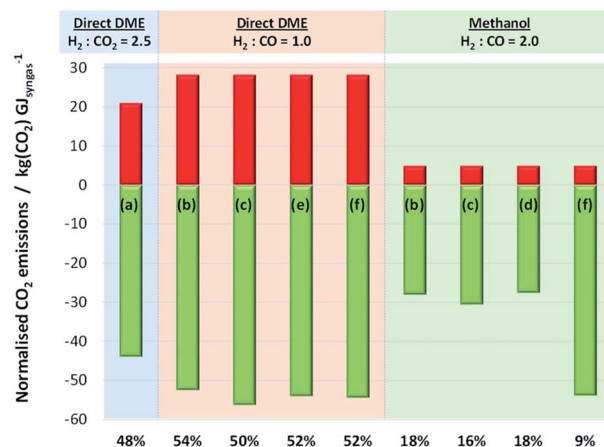

Fig. 15 Relative CO₂ emissions and CO₂ utilisation occurring in Stages 1 and 2 of systems for the production of methanol and direct DME. Negative CO₂ emissions (green) represent net CO₂ utilisation occurring in Stage 1 for schemes (b)–(f) in Fig. 13 and in Stage 2 for scheme (a). Conversely, positive CO₂ emissions (red) represent CO₂ liberated in Stage 2 for schemes (b)–(f) (due to WGS reaction) and in Stage 1 for scheme (a). Percentage values indicate the proportion of consumed CO₂ that is re-emitted. Direct CO₂ utilisation is modelled in the direct DME process, requiring syngas with H₂ : CO₂ = 2.5 produced in scheme (a). The remaining schemes convert CO₂ to CO in Stage 1, generating syngas with H₂ : CO = 2 for methanol production and H₂ : CO = 1 for DME production *via* the direct process in Stage 2.

The conversion of CO₂ to CO *via* high temperature electrolysis, followed by the WGS reaction with H₂O (scheme (f) with H₂ : CO = 2 in the final syngas product) resulted in the highest degree of CO₂ utilisation, with only 9% regenerated in Stage 2. The better performance of the system in scheme (f) is principally due to the exothermic nature of the WGS reaction which reduces the energy requirements in Stage 1. There was no significant difference between the performances of methanol systems with schemes (b), (c) or (d) in Stage 1. We note that additional energy requirements associated with cooling the WGS reactor have not been considered; these and other subordinate elements were beyond the scope of the present estimations. Nonetheless, Fig. 9S in the ESI† shows the energies released as heat (by exothermic reactions in Stage 2 processes such as WGS and by heat exchangers in Stage 1) relative to energy demands in Stage 1 for each scenario presented in Fig. 15; a fraction of the energy released as heat could be harnessed and used to decrease the energy consumption in Stage 1. However, conclusions based on the results in Fig. 15 are unlikely to be altered by these potential savings.

Based on results in Fig. 14 and 15 it can be concluded that in terms of energetic benefits and CO₂ utilisation, methanol is best synthesised from CO-based syngas that is produced upstream using high temperature electrolyzers or a combination of high temperature CO₂ electrolysis coupled with a WGS system. On the other hand, the direct DME process can utilise CO₂ directly; alternatively it can utilise syngas produced using the same methods as those identified for the case of methanol. In the cases of both methanol and direct DME syntheses, syngas production by a combination of an alkaline water electrolyser and a RWGS system yielded least favourable results.



In all cases, greater flexibility with the design of Stage 1 systems will be afforded when renewable sources of energy are available. For example, in the case of CRI,^{12,40} geothermal energy sources provide steam, which is used for generating electrical energy and for heating purposes. Alternatively solar energy could be used to generate electricity *via* photovoltaic devices, subject to location.

Although the supply of carbon dioxide is often seen as unlimited due to the vast quantities in which it is generated by industrial processes, its capture and purification are associated with significant energy demands and hence already at this initial stage, a fraction of the CO₂ recovered is released into the atmosphere;⁴¹ this factor will ultimately be important in life cycle analyses on the methanol and DME synthesis systems that utilise CO₂ as the sole source of carbon. However, in this study, the source of CO₂ and the energy associated with its recovery and purification were not considered as it was not a factor affecting system comparisons; CO₂ of similar purity is required, regardless of whether it is first converted to CO or fed into methanol/DME reactors directly. For example, to avoid problems associated with sulphur poisoning, the sulphur content in the syngas for the commonly employed Cu-based methanol/DME catalysts needs to be below circa 1 ppm (ref. 7) and, likewise, below circa 5 ppm for the nickel/iron/cobalt catalysts used typically in solid oxide electrolyzers.⁴²

Conclusions

The key question in this study was whether CO₂ could be fed directly to methanol/DME synthesis systems or whether its upstream conversion to CO was necessary. Hence, system efficiencies and extents of CO₂ conversion were examined in four methanol/DME synthesis systems as a function of hydrogen to total carbon molar ratios, H₂ : (CO₂ + CO), as well as CO₂ : CO ratios, in the system feed. Recycle of unreacted CO₂, as well as H₂ and CO, was enabled to minimise CO₂ emissions. Energy requirements for the operation of heat exchangers, compressors and distillation columns, as well as energy saving strategies such as the coupling of heat exchangers and also the utilisation of energy generated by combustion of vented gases, were included in system assessment. Highest system efficiencies for the methanol, direct DME and two-step DME synthesis systems were obtained at a non-stoichiometric H₂ : CO₂ ratio of 2.5 in the system feeds in the absence of upstream CO generation. For CO-based syngas, the highest efficiencies for the methanol/two-step DME and direct DME synthesis systems were obtained at stoichiometric H₂ : CO feed ratios of 2 and 1, respectively. Direct utilisation of CO₂ required maximum energy savings.

Taking account of energy requirements and CO₂ emissions associated with the upstream syngas production stage, it was determined that CO₂ could be utilised directly in the direct DME synthesis route, whereas upstream conversion of CO₂ to CO was necessary to achieve significant yields and increased overall CO₂ conversion with the methanol/two-step DME systems.

CO-based syngas production *via* high temperature co-electrolysis of H₂O and CO₂, or alternatively high temperature

CO₂ electrolysis coupled with the WGS process, were identified as the best technologies based on energy consumption and CO₂ conversion.

Acknowledgements

The authors thank the UK Engineering and Physical Sciences Research Council (EPSRC) for the post-doctoral research associateship for AH (grant EP/K035274/1). As per EPSRC requirements, we have made our experimental data available *via* Zenodo.org. The link to the data is: <https://zenodo.org/record/817412#.WUzky-vyvc>. It is also possible to access the data by entering the manuscript title into the search bar in <http://www.zenodo.org>.

References

- 1 A. Goeppert, M. Czaun, J. P. Jones, G. K. S. Prakash and G. A. Olah, *Chem. Soc. Rev.*, 2014, **43**, 7995.
- 2 IPCC, *IPCC Guidelines for National Greenhouse Gas Inventories, Prepared by the National Greenhouse Gas Inventories Programme*, ed. H. S. Eggleston, L. Buendia, K. Miwa, T. Ngara and K. Tanabe, IGES, Japan, 2006.
- 3 EU, *Roadmap for moving to a low-carbon economy in 2050*, European Commission, Brussels, Belgium, 2011, Short version, <http://eur-lex.europa.eu/legal-content/EN/ALL/?uri=CELEX:52011DC0112>, accessed in 03/2017.
- 4 EU, *Roadmap 2050: a practical guide to a prosperous, low-carbon Europe – Technical & economic analysis (full report)*, European Climate Foundation, 2010, <http://www.roadmap2050.eu/reports>, accessed in 03/2017.
- 5 G. A. Olah, A. Goeppert and G. K. S. Prakash, *Beyond Oil and Gas: The Methanol Economy*, Wiley-VCH, Weinheim, Germany, 2nd edn, 2009.
- 6 G. A. Olah, A. Goeppert and G. K. S. Prakash, *J. Org. Chem.*, 2009, **74**, 487.
- 7 P. L. Spath and D. C. Dayton, *Preliminary screening – technical and economic assessment of synthesis gas to fuels and chemicals with emphasis on the potential for biomass-derived syngas*, NREL/TP-510-34929, 2003.
- 8 A. de Klerk and E. Furimsky, *Catalysis in the Refining of Fischer-Tropsch Syncrude, Chapter 2: Production of Synthesis Gas*, Royal Society of Chemistry, 2010.
- 9 E. F. Sousa-Aguiar and L. Gorenstin Appel, *Catalysis*, 2011, **23**, 284.
- 10 Y. Ohno, *et al.*, *NKK Technical Review no. 85*, 2001, pp. 23–28; Y. Ohno, *Kagaku Keizai*, 2004, 89–93.
- 11 T. Matsushita, T. Haganuma and D. Fujita, *US Pat.*, 2013/0237618 A1, 2013.
- 12 <http://carbonrecycling.is/>, accessed in Dec 2016.
- 13 A. M. Shulenberg, F. R. Jonsson, O. Ingolfsson and K.-C. Tran, *US Pat.*, 2007/0244208 A1, 2007.
- 14 Blue Fuel Energy, <http://bluefuelenergy.com/>, accessed in 01/2017.
- 15 G. Jacobs and B. H. Davis, *Catalysis*, 2007, **20**, 122.
- 16 G. C. Chinchon, P. J. Denny, D. G. Parker, M. S. Spencer, K. C. Waugh and D. A. Whan, *Appl. Catal.*, 1987, **30**, 333–338.



- 17 C. Kuechen and U. Hoffmann, *Chem. Eng. Sci.*, 1993, **48**, 3767.
- 18 K. Klier, V. Chatikavanij, R. G. Herman and G. W. Simmons, *J. Catal.*, 1982, **74**, 343.
- 19 K. Law, J. Rosenfeld and M. Jackson, *Methanol as a renewable energy resource – White paper*, TIAX LLC, 2013, http://www.methanolfuels.org/wp-content/uploads/2013/05/MI-Renewable-Methanol-Pathways-White-Paper_final.pdf, accessed 03/2017.
- 20 L. Chen, Q. Jiang, Z. Song and D. Posarac, *Chem. Eng. Technol.*, 2011, **34**, 817.
- 21 *Report: GHG emissions of Blue Fuel methanol production process*, (S&T)² Consultants Inc, 2010, <http://www.methanolfuels.org/about-methanol/environment/>, accessed in 03/2017.
- 22 J. Haid and U. Koss, Lurgi's Mega-Methanol technology opens the door for a new era in down-stream applications, *Stud. Surf. Sci. Catal.*, 2001, **136**, 399–404.
- 23 M. Cheiky and J. Hillier, *US Pat.*, 8,835,517, 2014.
- 24 J. Sun, G. Yang, Y. Yoneyama and N. Tsubaki, *ACS Catal.*, 2014, **4**, 3346.
- 25 X. D. Peng, B. A. Toseland and P. J. A. Tijm, *Chem. Eng. Sci.*, 1999, **54**, 2787.
- 26 Y. Ohno, M. Yoshida, T. Shikada, O. Inokoshi, T. Ogawa and N. Inoue, *JFE Technical Report No. 8*, 2006.
- 27 X. D. Peng, A. W. Wang, B. A. Toseland and P. J. A. Tijm, *Ind. Eng. Chem. Res.*, 1999, **38**, 4381.
- 28 X. D. Peng, B. W. Diamond, T. C. R. Tsao and B. L. Bhatt, *US Pat.*, 6,458,856, 2002.
- 29 T. Shikada, Y. Ohno, T. Ogawa, M. Mizuguchi, M. Ono and K. Fujimoto, *US Pat.*, 6,147,125, 2000.
- 30 J. M. Douglas, *Conceptual design of chemical processes*, McGraw-Hill, London, 1988.
- 31 T. Ogawa, N. Inoue, T. Shikada and Y. Ohno, *J. Nat. Gas Chem.*, 2003, **12**, 219.
- 32 W. M. Haynes, *CRC Handbook of Chemistry and Physics*, CRC press, Taylor & Francis Group, London, 93rd edn, 2012.
- 33 2011 Guidelines to Defra/DECC's GHG Conversion Factors for Company Reporting: Methodology Paper for Emission Factors, August 2011, <http://www.defra.gov.uk>.
- 34 P. Patnaik, *A Comprehensive Guide to the Hazardous Properties of Chemical Substances, Chapter 19: Gases, Common Toxic, and Flammable*, John Wiley & Sons, Inc., 2007, pp. 402–409.
- 35 A. Roy, S. Watson and D. Infield, *Int. J. Hyd. Eng.*, 2006, **31**, 1964.
- 36 L. Kleiminger, T. Li, K. Li and G. H. Kelsall, *RSC Adv.*, 2014, **4**, 50003.
- 37 Haldor Topsoe, <http://www.topsoe.com/>, accessed in 09/2016.
- 38 L. Kleiminger, T. Li, K. Li and G. H. Kelsall, *Electrochim. Acta*, 2015, **179**, 565.
- 39 Q. Fu, C. Mabilat, M. Zahid, A. Brisse and L. Gautier, *Energy Environ. Sci.*, 2010, **3**, 1382.
- 40 G. A. Olah and G. K. S. Prakash, *US Pat.*, 8,791,166, 2014.
- 41 N. von der Assen, J. Jung and A. Bardow, *Energy Environ. Sci.*, 2013, **6**, 2721.
- 42 J. Bøgild Hansen, *Faraday Discuss.*, 2015, **182**, 9.

