

RESEARCH ARTICLE

 View Article Online
View Journal | View Issue

 Cite this: *Inorg. Chem. Front.*, 2023, **10**, 900

1,10-Phenanthroline ring-opening mediated by *cis*-{Re(CO)₂} complexes†

 Purificación Cañadas, ^a Julio Pérez, ^{a,b} Ramón López ^c and Lucía Riera ^{*b}

Pyridine ring-opening of a metal-coordinated 1,10-phenanthroline has been demonstrated for the first time. The reaction of stable, well-defined *cis,trans*-[Re(CO)₂(N-N)(N-RIm)(PMe₃)]OTf [N-N = 2,2'-bipyridine (bipy), N-RIm = *N*-alkylimidazole] compounds with KN(SiMe₃)₂ followed by the addition of an excess of electrophile (MeOTf) afforded bipy ring-opening products easily at room temperature. The new, electron rich analogous 1,10-phenanthroline (phen) *cis*-{Re(CO)₂} complexes allowed also, under mild conditions, the ring-opening of phen, which can be regarded as a model of coordinated quinoline, one of the impurities in fuels most difficult to eliminate by the hydrodenitrogenation (HDN) process. The phenanthroline ring-opening products are regiochemically different from those obtained with bipy, and the results of computational calculations suggest that the difference can be traced to the avoidance of a larger loss of aromaticity. The new ring-opening products have been spectroscopically characterized in solution and by means of X-ray diffraction in the solid state.

 Received 18th October 2022,
Accepted 29th November 2022

DOI: 10.1039/d2qi01890j

rsc.li/frontiers-inorganic

Introduction

Metal-mediated transformations of pyridine, quinoline and other N-heteroaromatics are of fundamental importance, in part due to the stability of the substrates, which makes them challenging reactions. On the other hand, they are expected to provide insight into the industrially very important, yet mechanistically poorly understood, hydrodenitrogenation (HDN) process, which is catalyzed by transition metal oxides.¹ This may lead to the development of more efficient transformations under milder conditions.² There are few examples of aromatic C–N bond cleavage processes mediated by molecular complexes, mainly due to the strength of the C–N bond, which often requires high temperatures and H₂ pressures to cleave.³

Pyridine ring-opening has been achieved with group 4 and 5 metal complexes, capable of binding pyridines in the very rare κ²(C,N) mode, in the presence of strongly reducing agents.^{4,5} Mindiola and co-workers developed a completely

different approach, namely ring-opening metathesis of pyridine with a metal–carbon triple bond.⁶ Afterwards, using the same highly reactive Ti(II) alkylidene complex, these authors achieved the ring-opening of bicyclic N-heterocycles quinoline and isoquinoline.⁷ Remarkably, the transition-metal mediated C–N bond cleavage of a fused aromatic N-heterocycle had not been previously reported, despite quinolines being the most challenging substrates to remove by HDN and also the most abundant in some of the fuels to be treated. On the other hand, ring opening of substituted imidazoles by lanthanides and uranium alkyl complexes has been reported.^{8,9} More recently, Luo and Hou reported the extrusion of a nitrogen atom from pyridine or quinoline rings in trinuclear titanium heptahydride complexes under relatively mild conditions.¹⁰

In a completely different way, we demonstrated pyridine ring-opening of the usually very inert bipy ligand coordinated to the cationic *fac*-tricarbonyl rhenium(I) fragment.¹¹ Bipy and phen are among the most extensively employed ligands in all fields of coordination chemistry;¹² however, nucleophilic addition to the coordinated bipy or phen was limited, prior to our work, to a few examples of inner-sphere hydride and alkyl metal-to-pyridine migrations.^{13,14} We found that deprotonation of the central CH group of 1-methylimidazole coordinated to the cationic *fac*-{Re(bipy)(CO)₃} fragment generated a strong nucleophile, which then attacks position 6 of bipy, leading to C–C coupling and dearomatization. The subsequent treatment with excess MeOTf resulted in the C–N bond cleavage and pyridine ring-opening.¹¹ Extension of this study to 4,4'-disubstituted-2,2'-bipyridine ligands¹⁵ showed that increasing the electron density of the bipy ligand (*i.e.* 4,4'-dimethoxy or

^aDepartamento de Química Orgánica e Inorgánica, Universidad de Oviedo, Julián Clavería, 8, 33006 Oviedo, Spain

^bCentro de Investigación en Nanomateriales y Nanotecnología (CINN), Consejo Superior de Investigaciones Científicas (CSIC), Avda. de la Vega, 4-6, 33940 El Entrego, Spain. E-mail: L.riera@cinn.es

^cDepartamento de Química Física y Analítica, Universidad de Oviedo, Julián Clavería, 8, 33006 Oviedo, Spain

 †Electronic supplementary information (ESI) available: Synthetic and computational details, including preparative procedures, spectroscopic data, the computational matrix, and NMR spectra for the characterization of compounds. CCDC 2192108–2192112. For ESI and crystallographic data in CIF or other electronic format see DOI: <https://doi.org/10.1039/d2qi01890j>



4,4'-dimethylamino-2,2'-bipyridine vs. parent bipy) makes it more reactive towards electrophiles once the C–C coupling reaction has taken place, yielding ring-opening products more easily.¹⁶ However, attempts to extend these results to the ring opening of coordinated phen failed, reflecting the more inert character of quinolines.

Herein we report the results obtained with *cis,trans*-[Re(CO)₂(PMe₃)(N–N)(N–RIm)]OTf (N–N = bipy, phen; N–RIm = *N*-alkylimidazole) complexes, related to those previously studied by our research group with the formula *fac*-[Re(CO)₃(N–N)(N–RIm)]OTf, but in which a carbonyl ligand has been replaced by a phosphane. Our working hypothesis is that this change makes the complexes substantially more electron rich, which should make them, once deprotonated, more reactive toward electrophiles and therefore better candidates for mediating ring-opening reactions. In fact, here we report the pyridine ring-opening of a coordinated phen, a quinoline model, a reaction, as far as we know, without precedents.

Results and discussion

Cationic *cis*-dicarbonyl trimethylphosphane imidazole Re(I) complexes containing bipy or phen ligands were prepared using a two-step procedure starting from *fac*-tricarbonyl [Re(CO)₃(N–N)(PMe₃)]OTf derivatives.¹⁷ First, the CO in *trans* disposition to the phosphane is replaced by acetonitrile (employed as a solvent), a reaction mediated by trimethylamine *N*-oxide, and, in a subsequent step, the labile nitrile ligand was replaced with an *N*-methyl- or *N*-mesityl- (mesityl = 2,4,6-trimethylphenyl) imidazole ligand (N–MeIm or N–MesIm, respectively) to afford the new *cis,trans*-[Re(CO)₂(N–N)(N–RIm)(PMe₃)]OTf¹⁸ compounds, as depicted in Scheme 1.

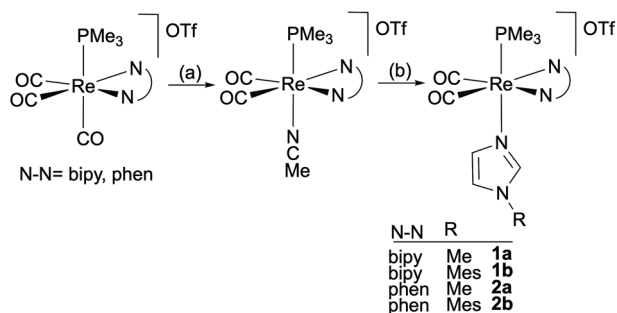
To start exploring the reactivity of the new *cis*-dicarbonyl imidazole Re(I) complexes containing bipy or phen ligands, a slight excess of KN(SiMe₃)₂ (1.2 eq.) was added to a solution of *cis,trans*-[Re(bipy)(CO)₂(N–MeIm)(PMe₃)]OTf (**1a**) in THF at –78 °C resulting in a color change from orange to dark red. Monitoring the reaction course by IR in solution in the carbonyl region showed the formation of a neutral product, as evidenced by the shifts in the IR bands to lower wavenumber ν_{CO} values (from 1921, 1847 cm^{–1} to 1894, 1818 cm^{–1}). Therefore,



Scheme 1 Synthesis of *cis,trans*-[Re(CO)₂(N–N)(N–RIm)(PMe₃)]OTf compounds. (a) Me₃NO·2H₂O, MeCN, Δ and (b) N–RIm, THF, Δ.

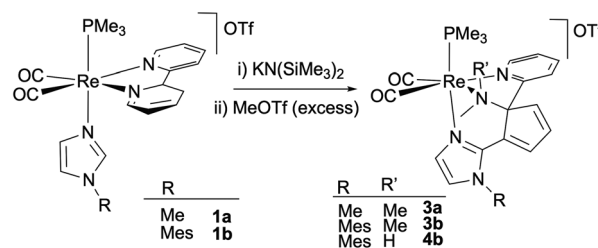

Scheme 2 Deprotonation followed by methylation of *cis,trans*-[Re(bipy)(CO)₂(N–RIm)(PMe₃)]OTf (**1a,b**) compounds.

the increase in electron density at the metal center does not preclude imidazole deprotonation by the potassium amide, although it makes the resulting neutral species too unstable for isolation. Electrophilic interception was then performed by the addition of MeOTf in CH₂Cl₂ to the reaction mixture, which afforded a new pyridine ring-opening product, **3a** (see Scheme 2), which could be purified by crystallization. The molecular structure of compound **3a**, determined by single crystal X-ray diffraction, consists of a triflate salt of a *cis*-dicarbonyl rhenium cation which displays a tridentate N-donor ligand. The latter results from the C–C coupling between the deprotonated *N*-methylimidazole and the bipy ligand (C15–C11 bond, Fig. 1 left). As a consequence of the double methylation at N12, the C11–N12 pyridine C–N bond is broken, resulting in pyridine ring-opening and the formation of cyclopentadienyl and dimethylamino moieties. Accordingly, the Re1–N12 [2.289(7) Å] bond distance is longer than that of Re1–N1 [2.197(5) Å] as expected for amino vs. imino moieties, respectively. The N12–C7 and C7–C11 bond distances [1.512(10) Å and 1.518(10) Å, respectively] are clearly indicative of single bonds, whereas the lengths of the C8–C9 and C10–C11 bonds [1.314(10) Å and 1.364(9) Å, respectively] reflect the multiple C–C bond character. The ¹H NMR spectrum of compound **3a** in CD₂Cl₂ is consistent with its solid-state structure, showing the signals corresponding to one pyridyl group, the three one-hydrogen signals of the cyclopentadienyl unit, and the two imidazole C–H groups. More significantly, in the aliphatic region three signals of three hydrogens each are found, two of which, at 2.63 and 3.18 ppm, correspond to the new dimethylamino group formed and the other, at 3.82 ppm, to the N–MeIm ligand. In the ¹³C NMR spectrum, the loss of the C_s symmetry is indicated by the presence of one signal for each carbon atom of the molecule, showing, for example, two different signals for the two carbonyl ligands at 202.2 and 204.6 ppm. Additional ¹³C NMR signals include that of the C2 atom, at 88.6 ppm, clearly indicating the Csp³ character, and the two methyl groups, at 56.5 and 47.6 ppm, that correspond to the double methylation of the nitrogen atom.

This behavior is reminiscent of that previously found for compound *fac*-[Re(bipy)(CO)₃(N–MeIm)]OTf,¹¹ which shows that the greater electron richness of the new *cis*-dicarbonyl Re(I) complexes does not lead to a qualitative difference in their reactivity.



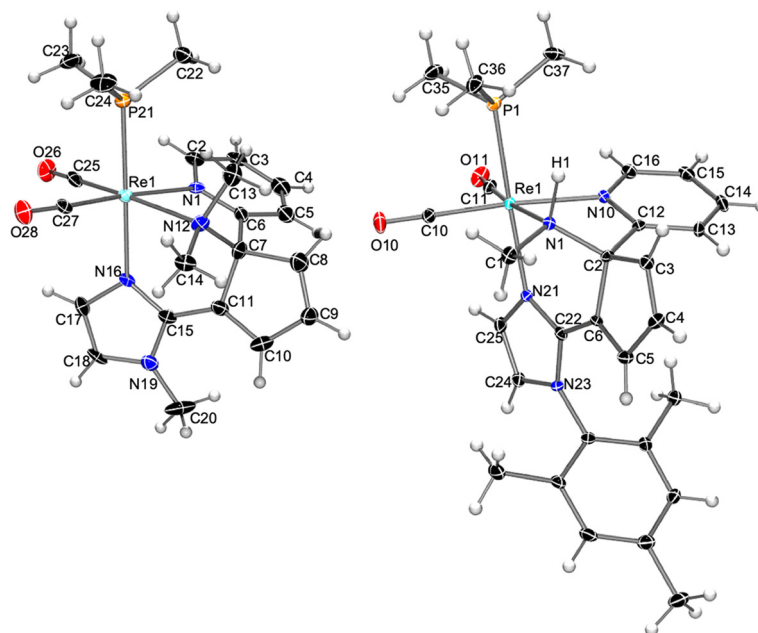

Fig. 1 Molecular structure of the cation of compounds **3a** (left) and **4b** (right), showing thermal ellipsoids at the 30% probability level.

We extended our study to the *N*-MesIm derivative, a ligand that, with the tricarbonyl complexes, had not led to a pyridine ring-opening reaction, but stopped at the C–C coupling and dearomatization product (see below).¹¹ The reaction of compound *cis,trans*-[Re(bipy)(CO)₂(*N*-MesIm)(PMe₃)]OTf (**1b**) with KN(SiMe₃)₂ (1.2 eq.) followed by MeOTf (2 eq.) led, as the NMR data in solution showed, to a mixture of two organometallic Re(I) compounds, one of which is a pyridine ring-opening product, **3b**, analogous to the previously described with the *N*-MeIm ligand, **3a** (Scheme 2). The molecular structure of the second product, **4b**, determined by X-ray diffraction, was found to correspond also to a pyridine ring-opening species. As shown in Fig. 1 right, the coordination of the rhenium cation of compound **4b** is analogous to that described above for **3a**, showing a C–C coupling between the imidazole and bipy ligands, and the pyridine ring opening of the latter, affording a central cyclopentadienyl unit. The main difference with **3b** is found in the nitrogen atom (N1), extruded from pyridine, which is now both methylated and protonated, instead of being doubly methylated. The Re1–N1 bond distance, of 2.236(4) Å, is consistent with an amino-type nitrogen as it is similar to that found in **3a** [2.289(7) Å]. The N1–C1 and N1–C2 bond distances [1.484(7) and 1.506(6) Å, respectively] are typical for single C–N bonds. The formation of **3b** or **4b** seems to be a competitive transformation¹⁹ that can be due to the high reactivity towards electrophiles of the intermediates formed and to the inevitable presence of traces of protic impurities in the reaction media.

These results reveal that the substitution of one CO ligand by trimethylphosphane was sufficient to promote the ring-opening of a pyridine ring of bipy with the *N*-MesIm ligand, with which no ring-opening occurred for the tricarbonyl system.

Once confirmed that the new imidazole Re(I) complexes are good candidates to mediate, under mild conditions, pyridine ring-opening reactions of a bipy ligand, we extended our studies to the analogous yet more challenging 1,10-phenanthroline complexes, *cis,trans*-[Re(CO)₂(*N*-RIm)(phen)(PMe₃)]OTf (R = Me, **2a**; Mes, **2b**). As mentioned previously, well-defined metal complexes able to break the C–N bond of fused, bicyclic *N*-heterocycles are hardly known. We have chosen the phen ligand as a model of this class of substrates, like quinoline or isoquinoline, which are the most difficult impurities to activate in industrial HDN and, accordingly, the ring-opening of this type of derivatives has been found to be particularly challenging.

Thus, the reaction of the phen derivatives **2a,b** with KN(SiMe₃)₂ (1.2 eq.) followed by MeOTf (2 eq.), was then performed to determine if it is able to promote the pyridine ring-opening reaction. In the case of the *N*-methylimidazole starting compound, **2a**, reaction workup and slow diffusion of hexane into a concentrated CH₂Cl₂ solution at –20 °C afforded a crystalline material that was found to be a mixture of two Re(I) organometallic compounds, **5a** (36%) and **6a** (31%), which could be separated by fractional recrystallization (Scheme 3). The molecular structure of **5a**, determined by single X-ray diffraction, showed it to be a triflate salt of a metallic cation resulting from double methylation of the nitrogen atom of a pyridine dearomatized ring (depicted in Fig. 2 left) that resembles the bipy ring-opening product **3a** (see above). The central imidazole carbon atom (C2), deprotonated by the strong base, acts as a nucleophile and attacks an *ortho* phen CH group, affording a new C–C bond [C2–C6, 1.493(6) Å]. The double methylation of the nitrogen atom of the dearomatized pyridine ring (N1) caused the N1–C17 bond cleavage, and the formation



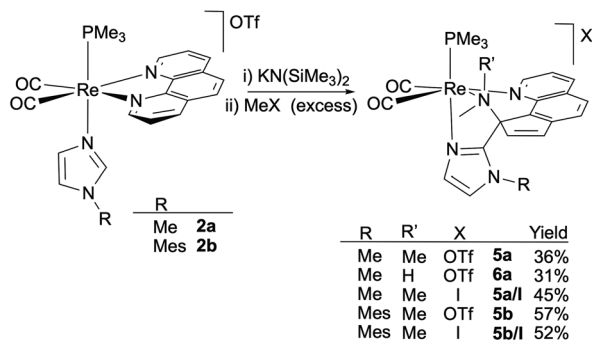

Scheme 3 Deprotonation/methylation sequence of 1,10-phenanthroline compounds *cis,trans*-[Re(CO)₂(N-R)Im](phen)(PMe₃)OTf (**2a,b**).

of the C6–C17 bond [1.526(6) Å], with the concomitant removal of N1 from the aromatic system. The resulting ligand is somewhat different from that obtained from the ring-opening of the bipy ligand, as in this case the carbon atom that has been attacked by the deprotonated imidazole (C6) is the same to which the dimethylamino group remains bonded. Therefore, the ligand can be described as a cyclopenta[*h*]quinoline bearing dimethylamino and imidazolyl groups at the 9 position (C6), which are both coordinated to the *cis*-{Re(CO)₂(PMe₃)} fragment. Probably this difference with the regiochemistry encountered with the bipy system is imposed by the rigidity of the fused central aromatic ring of the phen ligand and is crucial to the planarity of the resulting cyclopentaquinoline ligand. As far as we know, the ring opening reaction of a phen ligand has no precedents. NMR spectra of compound **5a** in CD₂Cl₂ were consistent with the solid-state structure. The ¹H NMR spectrum shows seven one-hydrogen signals, between 6.84 and 9.42 ppm, for the new conjugated cyclopentaquinoline unit, and three signals, in the aliphatic region, integrating three hydrogens each, that correspond to the N-MeIm and dimethylamino groups, along with the signal for the PMe₃ ligand (a 9-hydrogen doublet at 1.52 ppm). In the ¹³C NMR, the asymmetry of the molecule is evidenced by the presence of one signal for each carbon atom. The signals at 55.4 and 45.7 ppm correspond to the two new methyl groups of the dimethylamino moiety, and the chemical shift of the signal of

the C2 atom, at 81.2 ppm, clearly indicates that it is no longer an aromatic carbon atom.

Spectroscopic characterization of compound **6a** showed similar features to those observed for **5a**. The IR ν_{CO} bands in CH₂Cl₂, at 1917 and 1836 cm⁻¹, indicate the persistence of the *cis*-{CO}₂ unit and are at significantly higher wavenumbers than those in the neutral precursor (at 1895 and 1817 cm⁻¹ in THF) in accordance with the reaction with an electrophile. The ¹H NMR spectrum is, in contrast, quite surprising as it shows a set of seven signals, in the 6.71–9.68 ppm range, similar to that observed for the cyclopentaquinoline moiety in compound **5a**, but only one extra signal for a methyl group is shown in the aliphatic region. Furthermore, this signal, which integrates for three hydrogen atoms at 2.51 ppm, is a doublet showing a small coupling constant (5.9 Hz), and a correlation in the ¹H–¹H COSY spectrum with a one hydrogen broad-singlet at 6.11 ppm, supporting the presence of an NH group. The ¹³C NMR is consistent, and only two signals, at 36.4 and 35.2 ppm, are observed for the two methyl groups (apart from the signal of the PMe₃ ligand at 18.6 ppm), and the signal of the C2 atom is observed also in the aliphatic region, at 75.0 ppm, indicating its non-aromatic character. It seems, therefore, that, as for the bipy derivative **1b**, a protonated-methylated ring-opened product is also formed (Scheme 2). The molecular structure of the rhenium cation contained in **6a** is shown in Fig. 2 right (the triflate anion has been omitted for clarity). The solid-state structure of the Re(I) complex in **6a** is consistent with the NMR data, showing a cyclopentaquinoline moiety, similar to that found in **5a**, bonded, through the phen carbon atom C2, to nitrogen N1, which is also methylated and protonated. Another remarkable difference between the rhenium cation of **6a** and that of the dimethylated analog found in **5a** is the *cis* disposition of the PMe₃ ligand to the N-MeIm moiety, whereas in **5a** a *trans* disposition is observed.

Density functional theory calculations²⁰ were performed in order to rationalize the difference found in the ring-opening products of the reactions of Re(I) complexes containing bipy or phen ligands (Schemes 2 and 3, respectively). To this end, we optimized the structures of the experimentally found products **3a** and **5a** (**IIIa** and **Va'**, respectively, in Fig. 3) and those of

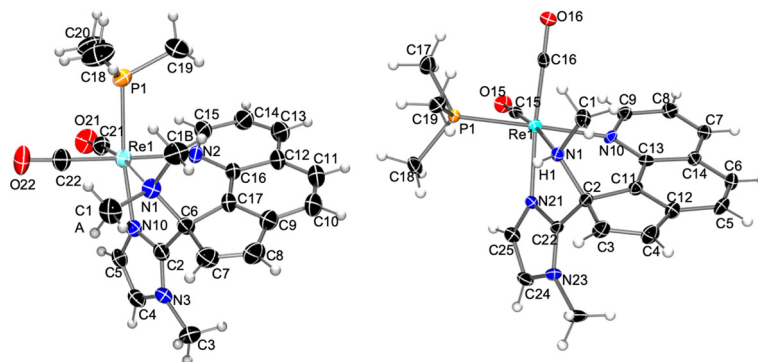

Fig. 2 Molecular structure of the cation of compounds **5a** (left) and **6a** (right), showing thermal ellipsoids at the 30% probability level.



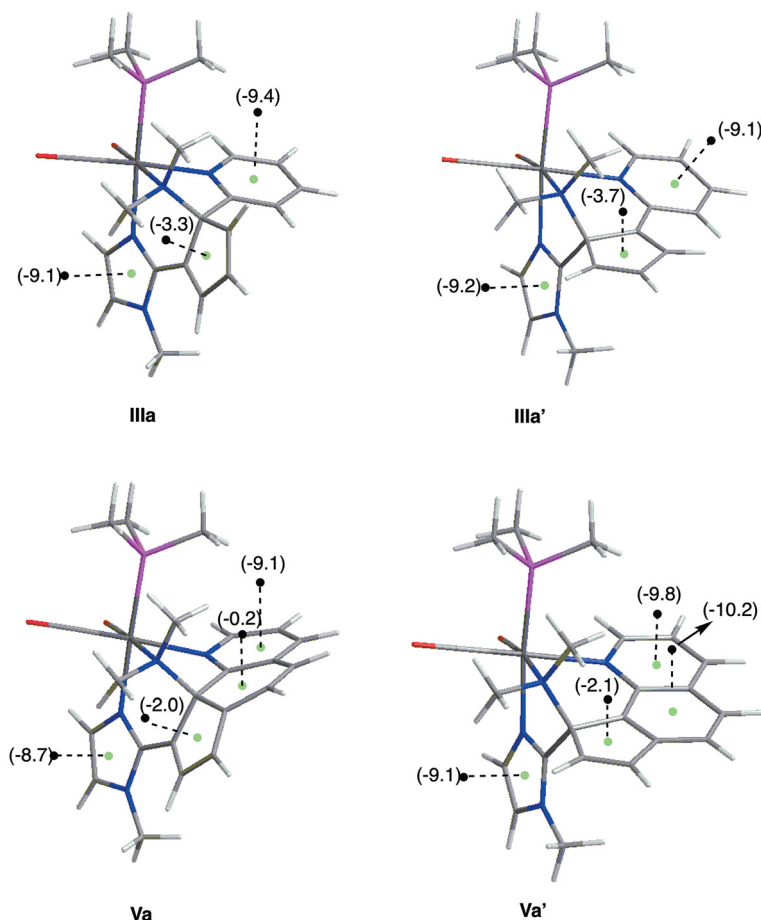

Fig. 3 CPCM-B3LYP/6-31+G(d) optimized structures of the two possible ring-opening products found for both the bipy and phen ligands. The NICS(1) values in ppm are provided in parentheses.

their isomers (**IIIa'** and **Va**, respectively, in Fig. 3). The prime symbol refers to the isomer in which dimethylamino and imidazolyl groups are bonded to the same carbon atom of the cyclopentadienyl moiety (for the phen ligand, this is the experimentally obtained isomer). For bipy, in **IIIa** the diene moiety of the cyclopentadienyl unit is almost in the same plane of the imidazole ring, whereas in the **IIIa'** isomer it is the pyridine ring the one it is coplanar with (see Fig. 3). As a result, in both isomers the diene fragment of the cyclopentadienyl ring formed in the reaction is conjugated with an aromatic system: the pyridyl ring in **IIIa'** and the imidazolyl unit in **IIIa**. The nucleus-independent chemical shift (NICS) values were calculated 1 Å above the ring critical points (RCP) of the electron density located on the pyridyl, cyclopentadienyl, and imidazolyl rings (RCP and NICS(1): green and black dots in Fig. 3, respectively). Keeping in mind that typical NICS(1) values, in parts per million (ppm), are *ca.* -10.2 for benzene,^{21,22} or -10.1 for pyridine,^{23,24} our computations do not show significant differences in the NICS(1) values of both complexes. As expected, pyridine (NICS(1) = -9.4/-9.1 ppm, for **IIIa/IIIa'** respectively) and imidazole (NICS(1) = -9.1/-9.2 ppm, for **IIIa/IIIa'** respectively) show notably larger

π -electronic delocalization than that of the cyclopentadienyl (NICS(1) = -3.3/-3.7 ppm, for **IIIa/IIIa'** respectively) rings. For bipy, the **IIIa** isomer (the one experimentally obtained) is 5.0 kcal mol⁻¹ in Gibbs energy in CH₂Cl₂ solution more stable than isomer **IIIa'**.²⁵ In contrast, for phen the isomer **Va'** is 24.5 kcal mol⁻¹ more stable than **Va**, which is in agreement with the fact that **5a** is the experimentally obtained product. This notable difference in stability can be, at least in part, ascribed to the loss of aromaticity of the central ring of the phen ligand in **Va** (see Fig. 3). This loss of aromaticity is clearly evidenced by the nucleus-independent chemical shift (NICS) values, as our computations reflect the strong aromatic character of the phen central ring in **Va'** (NICS(1) = -10.2 ppm) but not in **Va** (NICS(1) = -0.2 ppm). The other rings exhibit similar NICS(1) values for both isomers **Va** and **Va'**. On the other hand, the formation of **Va** would imply a severe distortion of the geometry, with concomitant loss of planarity and conjugation of the cyclopentadienyl unit and the two six-membered rings from phen which undoubtedly would imply a destabilizing effect (see Fig. 3). Considering jointly all of this, it can be proposed that the transition state for the formation of the **Va** isomer would be significantly higher in energy than



that corresponding to the formation of **Va'**, as a consequence of the loss of resonance energy.

Interestingly, the addition of freshly purified (by filtering through an alumina plug) methyl iodide instead of MeOTf in CH₂Cl₂, once compound *cis,trans*-[Re(CO)₂(N-MeIm)(phen)(PMe₃)]OTf (**2a**) has been deprotonated, afforded, after eight hours at room temperature, selectively the ring-opening product **5a/I** as the only rhenium complex in moderate yield. Compound **5a/I** was fully characterized in solution by means of IR and NMR, showing practically identical features to those found for **5a**.

Application of this deprotonation–methylation (MeI) sequence to the mesitylimidazole analog **2b** yielded the doubly methylated ring-opened species as the main organometallic product **5b/I**, in 52% yield (Scheme 3). It is remarkable that the ring-opening of a pyridine unit of a Re(I) coordinated phen ligand is exclusively found not only for the more electron rich complex **2a**, bearing an N-MeIm ligand, but also for the mesitylimidazole analog **2b**. Slow diffusion of hexane into a concentrated solution of **5b** [obtained by reaction of **2b** with KN(SiMe₃)₂ and MeOTf (2 eq.)] yielded orange crystals that allowed the molecular structure determination by X-ray diffraction. Fig. 4 shows the structure of the cation of **5b**, confirming the structure proposed on the basis of the spectroscopic data in solution, *i.e.* the double methylation of the nitrogen N1, which originates from the phen ligand, and, which as a consequence was extruded from the aromatic ligand yielding a cyclopentaquinoline moiety. The latter is also coupled through position 9 (C2 in Fig. 4) to the central N-MesIm carbon atom (C22), so altogether there is a tridentate N-donor ligand facially coordinated to the Re atom through amino (N1), imino (N10) and imidazolyl (N21) nitrogen atoms.

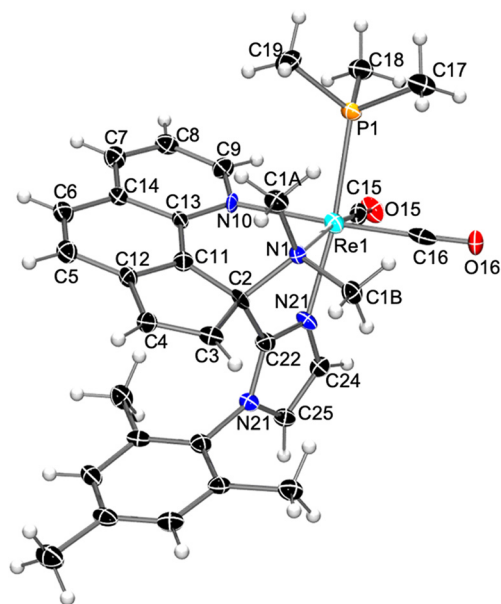

Fig. 4 Molecular structure of the cation of compound **5b**, showing thermal ellipsoids at the 30% probability level.

Conclusions

The use of electron rich *cis*-{Re(CO)₂} trimethylphosphane complexes allowed the pyridine ring-opening of a phen ligand for the first time. The use of the more electron rich *cis,trans*-[Re(CO)₂(N-N)(N-RIm)(PMe₃)]OTf (N-N= bipy, phen; R = Me, Mes) compounds [compared to the previously studied *fac*-[Re(CO)₃(N-N)(N-RIm)]OTf (N-N= bipy, phen; R = Me, Mes)] does not preclude the deprotonation of the imidazole central CH group upon addition of the strong base KN(SiMe₃)₂. The resulting dearomatized C–C coupling products are highly reactive towards electrophiles to afford, under mild conditions, products resulting from the ring opening of a pyridyl unit of the bipy or phen ligands. Bipy and phen ring-opening products differ in the C–N bond which is broken in the reaction: for bipy, it is the N1–C6 bond, and for phen, it is the other C–N bond [N1–C11]. Computational calculations reveal that for the latter there is a large difference in the stability of both isomers, mainly due to the loss of aromaticity of the phen central ring if the isomer analogue to the bipy one was formed.

Data availability

Crystallographic data for compounds **3a**, **4b**, **5a**, **5b** and **6a** have been deposited at the CCDC under CCDC 2192108–2192112† The datasets supporting this article have been uploaded as part of the ESI.†

Author contributions

LR and JP conceived the project. PC performed the investigations and analysed data with input from LR. RL performed and analysed the computational results. LR prepared the manuscript with the contribution of all authors.

Conflicts of interest

There are no conflicts to declare.

Acknowledgements

This work was supported by Ministerio de Ciencia, Innovación y Universidades/FEDER (grant PGC2018-100013-B-I00). The authors thank Servicios Científico-Técnicos de la Universidad de Oviedo for technical support and the use of RIAIDT-USC analytical facilities.

References

- 1 S. S. Bello, C. Wang, M. Zhang, H. Gao, Z. Han, L. Shi, F. Su and G. Xu, A review on the reaction mechanism of hydrodesulfurization and hydrodenitrogenation in heavy oil



- upgrading, *Energy Fuels*, 2021, **35**, 10998; E. Furimsky and F. E. Massoth, Hydrodenitrogenation of petroleum, *Catal. Rev. Sci. Eng.*, 2005, **47**, 297; R. Prins, Catalytic hydrodenitrogenation, *Adv. Catal.*, 2001, **46**, 399; T. C. Ho, Hydrodenitrogenation Catalysis, *Catal. Rev. Sci. Eng.*, 1988, **30**, 117.
- M. Bachrach, T. J. Marks and J. M. Notestein, Understanding the hydrodenitrogenation of heteroaromatics on a molecular level, *ACS Catal.*, 2016, **6**, 1455; C. Bianchini, A. Meli and F. Vizza, Modelling the hydrodenitrogenation of aromatic N-heterocycles in the homogeneous phase, *Eur. J. Inorg. Chem.*, 2001, 43.
 - K. J. Weller, P. A. Fox, S. D. Gray and D. E. Wigley, Homogeneous models for hydrodenitrogenation catalysis, *Polyhedron*, 1997, **16**, 3139; J. R. Katzer and R. Sivasubramanian, Process and catalyst needs for hydrodenitrogenation, *Catal. Rev. Sci. Eng.*, 1979, **20**, 155.
 - K. J. Weller, I. Filippov, P. M. Briggs and D. E. Wigley, Pyridine degradation intermediates as models for hydrodenitrogenation catalysis: preparation and properties of a metallapyridine complex, *Organometallics*, 1998, **17**, 322; K. J. Weller, I. Filippov, P. M. Briggs and D. E. Wigley, Isolation and characterization of a monomeric metallapyridine complex: models for pyridine hydrodenitrogenation intermediates, *J. Organomet. Chem.*, 1997, **528**, 225; K. D. Allen, M. A. Bruck, S. D. Gray, R. P. Kingsborough, D. P. Smith, K. J. Weller and D. E. Wigley, Quinoline binding mode as a function of oxidation state in aryloxide-supported tantalum complexes: models for hydrodenitrogenation catalysis, *Polyhedron*, 1995, **14**, 3315; K. J. Weller, S. D. Gray, P. M. Briggs and D. E. Wigley, Mechanistic aspects of carbon-nitrogen bond cleavage in an $\eta^2(\text{N,C})$ -pyridine complex: intimate details of metal to ligand aryl migrations and their relevance to hydrodenitrogenation catalysis, *Organometallics*, 1995, **14**, 5588; S. D. Gray, K. J. Weller, M. A. Bruck, P. M. Briggs and D. E. Wigley, Carbon-nitrogen bond cleavage in an $\eta^2(\text{N,C})$ -pyridine complex induced by intramolecular metal-to-ligand alkyl migration: models for hydrodenitrogenation catalysis, *J. Am. Chem. Soc.*, 1995, **117**, 10678; S. D. Gray, D. P. Smith, M. A. Bruck and D. E. Wigley, Regioselective carbon-nitrogen bond cleavage in an $\eta^2(\text{N,C})$ -coordinated pyridine and an $\eta^1(\text{N}) \rightarrow \eta^2(\text{N,C})$ bonding rearrangement in coordinated quinoline: models for hydrodenitrogenation catalysis, *J. Am. Chem. Soc.*, 1992, **114**, 5462.
 - J. B. Bonanno, A. S. Veige, P. T. Wolczanski and E. B. Lobkovsky, Amide derivatives of tantalum and niobium-promoted ring opening of 3,5-lutidine, *Inorg. Chim. Acta*, 2003, **345**, 173; T. S. Kleckley, J. L. Bennet, P. T. Wolczanski and E. B. Lobkovsky, Pyridine C=N bond cleavage mediated by $(\text{silox})_3\text{Nb}$ ($\text{silox} = {}^t\text{Bu}_3\text{SiO}$), *J. Am. Chem. Soc.*, 1997, **119**, 247; K. J. Covert, D. R. Neithamer, M. C. Zonnneville, R. E. LaPointe, C. P. Schaller and P. T. Wolczanski, Pyridine and related adducts, $(\text{silox})_3\text{ML}$ ($\text{M} = \text{scandium, titanium, vanadium, tantalum}$): η^1 -pyridine-*N* vs η^2 -pyridine-*N,C* ligation, *Inorg. Chem.*, 1991, **30**, 2494; D. R. Neithamer, L. Parkanyi, J. F. Mitchell and P. T. Wolczanski, η^2 -(N,C)-Pyridine and μ - $\eta^2(1,2)$: $\eta^2(4,5)$ -benzene complexes of $(\text{silox})_3\text{Ta}$ ($\text{silox} = {}^t\text{Bu}_3\text{SiO}^-$), *J. Am. Chem. Soc.*, 1988, **110**, 4421.
 - A. R. Fout, B. C. Bailey, J. Tomaszewski and D. J. Mindiola, Cyclic denitrogenation of N-heterocycles applying a homogeneous titanium reagent, *J. Am. Chem. Soc.*, 2007, **129**, 12640; B. C. Bailey, H. Fan, J. C. Huffman, M. H. Baik and D. J. Mindiola, Room temperature ring-opening metathesis of pyridines by a transient $\text{Ti} \equiv \text{C}$ linkage, *J. Am. Chem. Soc.*, 2006, **128**, 6798.
 - S. Baek, T. Kurogi, D. Kang, M. Kamitani, S. Kwon, D. P. Solowey, C.-H. Chen, M. Pink, P. J. Carroll, D. J. Mindiola and M.-H. Baik, Room-temperature ring-opening of quinoline, isoquinoline, and pyridine with low-valent titanium, *J. Am. Chem. Soc.*, 2017, **139**, 12804.
 - M. J. Monreal, S. Kjan and P. L. Diaconescu, Beyond C-H activation with uranium: a cascade of reactions mediated by a uranium dialkyl complex, *Angew. Chem., Int. Ed.*, 2009, **48**, 8352; C. T. Carver, D. Benitez, K. L. Miller, B. N. Williams, E. Tkatchouk, W. A. Goddard III and P. L. Diaconescu, Reactions of Group III biheterocyclic complexes, *J. Am. Chem. Soc.*, 2009, **131**, 10269; C. T. Carver and P. L. Diaconescu, Ring-opening reactions of aromatic N-heterocycles by scandium and yttrium alkyl complexes, *J. Am. Chem. Soc.*, 2008, **130**, 7558.
 - W. Yi, J. Zhang, S. Huang, L. Weng and X. Zhou, Reactivity of Tp^{Me_2} -supported yttrium alkyl complexes toward aromatic N-heterocycles: ring-opening or C=C bond formation directed by C-H activation, *Chem. – Eur. J.*, 2014, **20**, 867; Y. Zhang, J. Zhang, J. Hong, F. Zhang, L. Weng and X. Zhou, Versatile reactivity of β -diketiminato-supported yttrium dialkyl complex toward aromatic N-heterocycles, *Organometallics*, 2014, **33**, 7052.
 - S. Hu, G. Luo, T. Shima, Y. Luo and Z. Hou, Hydrodenitrogenation of pyridines and quinolines at multinuclear titanium hydride framework, *Nat. Commun.*, 2017, **8**, 1866.
 - M. A. Huertos, J. Pérez and L. Riera, Pyridine ring opening at room temperature at a rhenium tricarbonyl bipyridine complex, *J. Am. Chem. Soc.*, 2008, **130**, 5662.
 - A. P. Smith and C. L. Fraser, Bipyridine ligands, in *Comprehensive Coordination Chemistry II*, ed. J. A. McCleverty and T. J. Meyer, Elsevier Pergamon, Oxford, 2004, vol. 1, pp. 1–23.
 - C. Weetman, M. S. Hill and M. F. Mahon, Magnesium-catalysed hydroboration of pyridines: kinetic analysis and poly-pyridine dearomatisation, *Polyhedron*, 2016, **103**, 115; S. Leelasubcharoen, K.-C. Lam, T. E. Concolino, A. L. Rheingold and K. H. Theopold, Unusual transformations of a bipyridine ligand in attempts to trap a terminal chromium(III) alkylidene, *Organometallics*, 2001, **20**, 182; L. M. Kobriger, A. K. McMullen, P. E. Fanwicck and I. P. Rothwell, Complexation and intramolecular alkylation of bipyridyl ligands by $\text{Zr}(\text{OAr})_2\text{R}_2$ ($\text{R} = \text{CH}_3, \text{CH}_2\text{Ph}$) compounds, *Polyhedron*, 1989, **8**, 77.



- 14 An example of dearomatization of a 2,2':6',2''-terpyridine coordinated to Lu(III) has been reported, see: K. C. Jantunen, B. L. Scott, P. J. Hay, J. C. Gordon and J. L. Kiplinger, Dearomatization and functionalization of terpyridine by lutetium(III) alkyl complexes, *J. Am. Chem. Soc.*, 2006, **128**, 6322.
- 15 A computational study on the effect of different substituents onto the electronic properties of a 2,2'-bipyridine coordinated to Rh(III) has been reported: D. R. Pahls, J. T. Groves, T. B. Gunnoe and T. R. Cundari, Theoretical study of reductive functionalization of methyl ligands of group 9 complexes supported by two bipyridyl ligands: a key step in catalytic hydrocarbon functionalization, *Organometallics*, 2014, **33**, 1936.
- 16 M. Espinal-Viguri, S. Fombona, D. Álvarez, J. Díaz, M. I. Menéndez, R. López, J. Pérez and L. Riera, Regiochemistry control by bipyridine substituents in the deprotonation of Re^I and Mo^{II} *N*-alkylimidazole complexes, *Chem. – Eur. J.*, 2019, **25**, 92533.
- 17 The method used herein is a variation of that previously reported in: R. Arévalo, R. López, L. Falvello, L. Riera and J. Pérez, Building C(sp³) molecular complexity on 2,2'-bipyridine and 1,10-phenanthroline in rhenium tricarbonyl complexes, *Chem. – Eur. J.*, 2021, **27**, 379; R. Arévalo, M. I. Menéndez, R. López, I. Merino, L. Riera and J. Pérez, Nucleophilic additions to coordinated 1,10-phenanthroline: intramolecular, intermolecular, reversible and irreversible, *Chem. – Eur. J.*, 2016, **22**, 17972. The main advantages are that it is carried out at room temperature, affords pure *fac*-[Re(CO)₃(N–N)(PMe₃)]OTf compounds, and avoids the use of potentially explosive perchlorate salts.
- 18 See the ESI† for further experimental details.
- 19 Based on the integration of the signals in the ³¹P NMR spectrum of the reaction mixture, the **3b**:**4b** ratio is 1.05 : 1.
- 20 The geometry and energy of the optimized ring-opening products investigated were studied at the CPCM-B3LYP/6-31+G(d)-LANL2DZ level of theory (see the ESI† for more details).
- 21 Z. Chen, C. S. Wannere, C. Corminboeuf, R. Puchta and P. v. R. Schleyer, Nucleus-independent chemical shifts (NICS) as an aromaticity criterion, *Chem. Rev.*, 2005, **105**, 3842.
- 22 L. Andjelkovic, M. Peric, M. Zlatar, S. Grubisic and M. Gruden-Pavlovic, Magnetic criteria of aromaticity in a benzene cation and anion: how does the Jahn-Teller effect influence the aromaticity?, *Tetrahedron Lett.*, 2012, **53**, 794.
- 23 D. S. J. Shobe, Calculations on the Group 15 intraring substituted benzenes (pyridine to bismin series) and their datively bonded oxides and sulfides, *Phys. Chem. A*, 2005, **109**, 9118.
- 24 I. Pausescu, M. Medeleanu, M. Stefanescu, F. Peter and R. Pop, A DFT study on the stability and aromaticity of heterobenzenes containing group 15 elements, *Heteroat. Chem.*, 2015, **26**, 206.
- 25 The possible formation of **IIIa** from **IIIa'** has been analyzed given the small energy difference found between both isomers, but it has been discarded considering the high energy barrier found (see the ESI† for more details).

