



**Editorial Staff****Executive Editor**

Emma Eley

**Deputy Editor**

Jon Ferrier

**Editorial Production Manager**

Sarah Whitbread

**Assistant Editors**

Jamie Purcell, Alexander John, Emily Ellison, Jack Pitchers, Clare Fitzgerald

**Editorial Assistant**

Alex Holiday

**Publishing Assistant**

Lee Colwill

**Publisher**

Neil Hammond

For queries about submitted papers please contact Sarah Whitbread, Editorial Production Manager in the first instance. E-mail: [esadvances@rsc.org](mailto:esadvances@rsc.org)

For pre-submission queries please contact

Emma Eley, Executive Editor.

E-mail: [esadvances-rsc@rsc.org](mailto:esadvances-rsc@rsc.org)

Environmental Science: Advances (electronic: ISSN 2754-7000) is published 12 times a year by the Royal Society of Chemistry, Thomas Graham House, Science Park, Milton Road, Cambridge, UK CB4 0WF.

Environmental Science: Advances is a Gold Open Access journal and all articles are free to read.

Whilst this material has been produced with all due care, the Royal Society of Chemistry cannot be held responsible or liable for its accuracy and completeness, nor for any consequences arising from any errors or the use of the information contained in this publication. The publication of advertisements does not constitute any endorsement by the Royal Society of Chemistry or Authors of any products advertised. The views and opinions advanced by contributors do not necessarily reflect those of the Royal Society of Chemistry which shall not be liable for any resulting loss or damage arising as a result of reliance upon this material. The Royal Society of Chemistry is a charity, registered in England and Wales, Number 207890, and a company incorporated in England by Royal Charter (Registered No. RC000524), registered office: Burlington House, Piccadilly, London W1J 0BA, UK, Telephone: +44 (0) 207 4378 6556.

**Advertisement sales:**

Tel +44 (0) 1223 432246; Fax +44 (0) 1223 426017;

E-mail [advertising@rsc.org](mailto:advertising@rsc.org)

For marketing opportunities relating to this journal, contact [marketing@rsc.org](mailto:marketing@rsc.org)

# Environmental Science: Advances

[rsc.li/esadvances](http://rsc.li/esadvances)

Uniting disciplines to solve environmental challenges

**Editorial Board****Editors-in-Chief**

Zongwei Cai, Hong Kong Baptist University, Hong Kong

Kevin Jones, Lancaster University, UK

Célia M. Manaia, Universidade Católica Portuguesa, Portugal

**Associate Editors**

Ru-jin Huang, Institute of Earth Environment, Chinese Academy of Sciences, China

Liwu Zhang, Fudan University, China

Pernilla Bohlin-Nizzetto, Norwegian Institute for Air Research, Norway

David Weissbrodt, Norwegian University of Science and Technology, Norway

Ngai Yin Yip, Columbia University, USA

**Members**

Silvia Lacorte seult, IDAEA-CSIC, Spain

**Advisory Board**

Damià Barceló, Institute of Environmental Assessment and Water Research, Spain

Zhi-Feng Chen, Guangdong University of Technology, China

Jiping Chen, Dalian Institute of Chemical Physics, China

Chun Cheng Chen, Institute of Chemistry, Chinese Academy of Sciences, Beijing, China

Saikat Dutta, Amity University, India

Maofa Ge, Institute of Chemistry, Chinese Academy of Sciences, Beijing, China

Tom Harner, Environment and Climate Change Canada, Canada

Rong Ji, Nanjing University, China

Ramanan Laxminarayan, One Health Trust, Washington D.C., United States

Yongjie Li, University of Macau, Taipa, Macao

Hemi Luan, Guangdong University of Technology, China

Jurgita Ovadnevaite, National University of Ireland Galway, Ireland

Francois Perreault, University of Quebec at Montreal, Canada

Debra Rodrigues, University of Houston, USA

Andreas Schäffer, Institute for Environmental Research, RWTH Aachen University, Germany

Philippe Schmitt-Kopplin, Helmholtz Zentrum München, Germany

Dörthe Tetzlaff, Humboldt University of Berlin and IGB Leibniz Institute of Freshwater Ecology and Inland Fisheries

Mark van Loosdrecht, Technische Universiteit Delft, Netherlands

Meizhen Wang, Zhejiang Gongshang University, China

Zhe Wang, Hong Kong University of Science and Technology, Hong Kong, China

Dengsong Zhang, Shanghai University, China

Xuan Zhang, University of California, Merced, USA

**Information for Authors**

Full details on how to submit material for publication in Environmental Science: Advances are given in the Instructions for Authors (available from <http://www.rsc.org/authors>). Submissions should be made via the journal's homepage: [rsc.li/esadvances](http://rsc.li/esadvances)

Authors may reproduce/republish portions of their published contribution without seeking permission from the Royal Society of Chemistry, provided that any such republication is accompanied by an acknowledgement in the form: (Original Citation)–Reproduced by permission of the Royal Society of Chemistry.

This journal is © The Royal Society of Chemistry 2023.

Apart from fair dealing for the purposes of research or private study for non-commercial purposes, or criticism or review, as permitted under the Copyright, Designs and Patents Act 1988 and the Copyright and Related Rights Regulation 2003, this publication may only be reproduced, stored or transmitted, in any form or by any means, with the prior permission in writing of the Publishers or in the case of reprographic reproduction in accordance with the terms of licences issued by the Copyright Licensing Agency in the UK. US copyright law is applicable to users in the USA.

Registered charity number: 207890



1505

### Machine learning for hours-ahead forecasts of urban air concentrations of oxides of nitrogen from univariate data exploiting trend attributes

David A. Wood

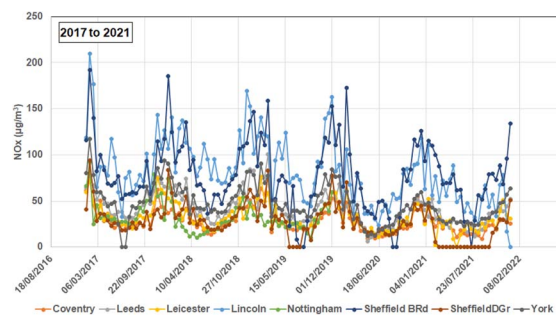

1527

### Synthesis and characterization of fluorescent gold clusters encapsulated in PNIPAM and PAAM hydrogels for selective detection of mercury in water

Gustavo A. Monti,\* Gustavo A. Pino and Diego Acevedo

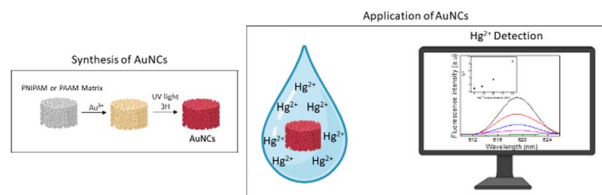

1540

### The association of air quality and complex atmospheric oxidation chemistry in the dispersion and deposition of SARS-CoV-2-laden aerosols

Sandhiya Lakshmanan,\* Ranjana Aggarwal, Kittusamy Senthilkumar and Anupama Upadhayay

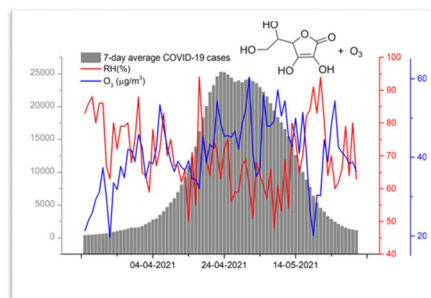

1554

### A porous bentonite-coconut husk composite for the enhanced adsorption of selected emerging contaminants from aqueous solution

Abisola O. Egbedina,\* Simisola B. Odejobi, Babatunde J. Akinbile, Abayneh A. Ambushe, Bamidele I. Olu-Owolabi and Kayode O. Adebowale

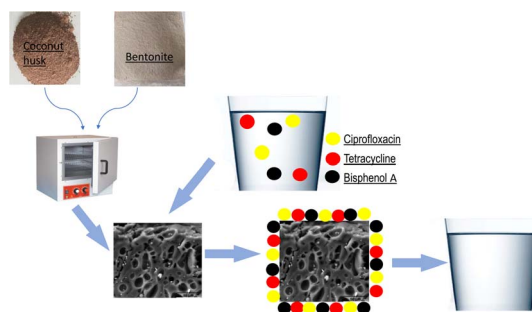

1566

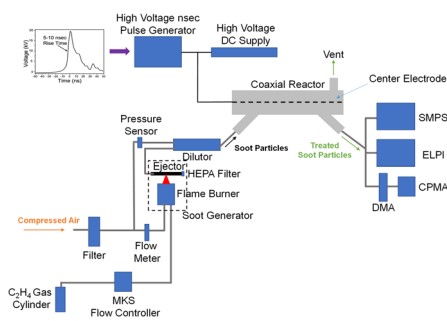

### Ion density-enhanced electrostatic precipitation using high voltage nanosecond pulses

Boxin Zhang, Indu Aravind, Sisi Yang, Sizhe Weng, Bofan Zhao, Grace Johnson, Lucas Brown, Jason Olfert, Heejung Jung and Stephen B. Cronin\*

1574

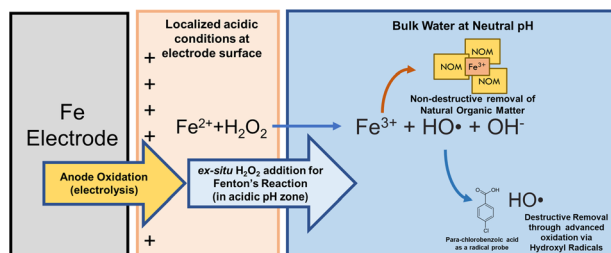

### Peroxi-electrocoagulation for treatment of trace organic compounds and natural organic matter at neutral pH

Donald R. Ryan, Patrick J. McNamara, Claire K. Baldus, Yin Wang and Brooke K. Mayer\*

1587

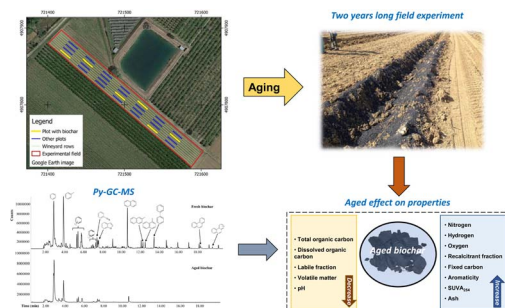

### Changes of labile, stable and water-soluble fractions of biochar after two years in a vineyard soil

Alessandro G. Rombolà,\* Nicolas Greggio,\* Daniele Fabbri, Andrea Facchin, Cristian Torri, Roberta Pulcher, Carlotta Carlini, Enrico Balugani, Diego Marazza, Denis Zannoni and Alessandro Buscaroli

1600

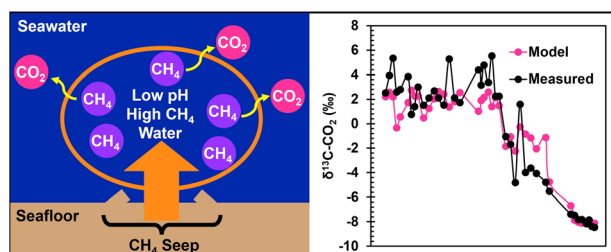

### The emission of low pH water from Gulf of Mexico seeps as revealed by $\delta^{13}\text{C}-\text{CO}_2$ and methane oxidation data

Sydney I. Loudon\* and John D. Kessler

