

IN THIS ISSUE

ISSN 1463–9076 CODEN PPCPFQ 26(24) 16913–17406 (2024)



Cover

See Jesse Maassen, Erin R. Johnson *et al.*, pp. 16947–16954. Image reproduced by permission of Mohammad Rafiee Diznab from *Phys. Chem. Chem. Phys.*, 2024, 26, 16947.



Inside cover

See Florentino López-Urías *et al.*, pp. 16955–16962. Image reproduced by permission of Florentino López-Urías from *Phys. Chem. Chem. Phys.*, 2024, 26, 16955.

EDITORIAL

16929

Physical chemistry of the energy transition

Robert Schlögl, Alec M. Wodtke, Timo Jacob and Svetlana Schauer mann



Timo Jacob (Ulm University)



Svetlana Schauer mann (Kiel University)

Bunsen-Tagung 2023: Physical Chemistry of the Energy Transition



Robert Schlögl (Fritz Haber Institute of the Max Planck Society)



Alec Wodtke (Georg-August University & Department of Dynamics at Surfaces, Max-Planck-Institute for Multidisciplinary Sciences)

PERSPECTIVE

16931

“Nano-egg” superstructures of hydrophobic nanocrystals dispersed in water

M. P. Pileni

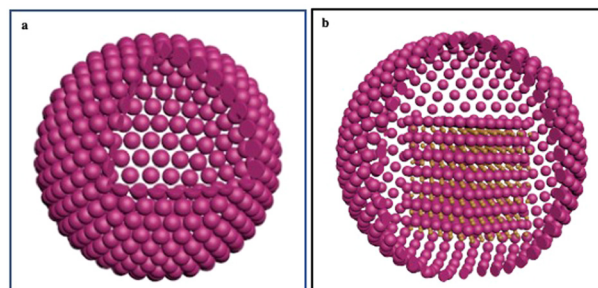

RSC Advances

At the heart of open access for
the global chemistry community

Editor-in-chief

Russell J Cox

Leibniz Universität Hannover, Germany

We stand for:



Breadth We publish work in all areas of chemistry and reach a global readership



Affordability Low APCs, discounts and waivers make publishing open access achievable and sustainable



Quality Research to advance the chemical sciences undergoes rigorous peer review for a trusted, society-run journal



Community Led by active researchers, we publish quality work from scientists at every career stage, and all countries

Submit your work now

rsc.li/rsc-advances

@RSC_Adv



COMMUNICATION

16942

Polymer solubility mechanism in ionic liquids: $^1\text{H-NMR}$ spectra and two-parameter hydrogen bonding analysis

Ming-Xuan Du,* Ya-Fei Yuan, Jin-Ming Zhang, Jia-Jian Liu and Chen-Yang Liu*

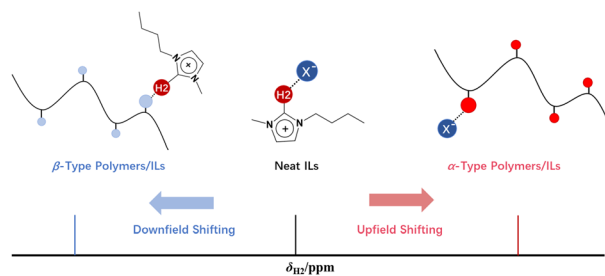

RESEARCH PAPERS

16947

Designing barrier-free metal/ MoS_2 contacts through electrone insertion

Mohammad Rafiee Diznab, Adrian F. Rumson, Jesse Maassen* and Erin R. Johnson*

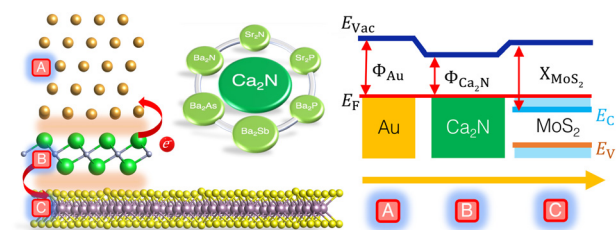

16955

Thermodynamics of resonating-valence-bond states toward the understanding of quantum spin liquid phenomena

Florentino López-Urías,* Alberto Rubio-Ponce, Emilio Muñoz-Sandoval and Francisco Sánchez-Ochoa

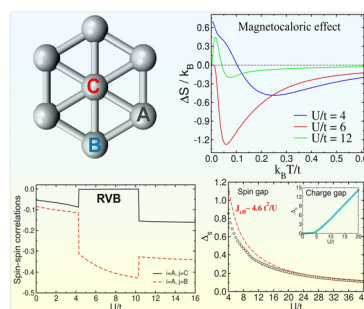

16963

Discovery of superconductivity in technetium borides at moderate pressures

Xiangru Tao, Aiqin Yang, Yundi Quan, Biao Wan, Shuxiang Yang* and Peng Zhang*

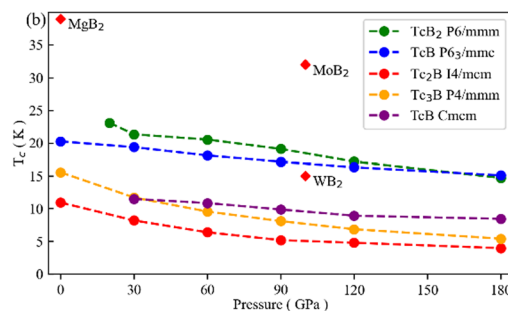

16972

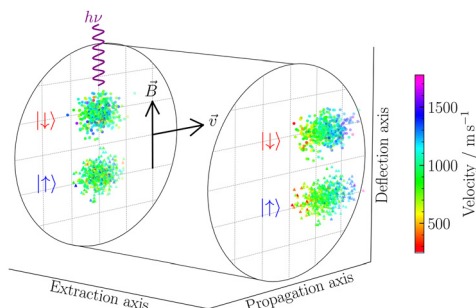

Out-of-focus spatial map imaging of magnetically deflected sodium ammonia clusters

D. P. Borgeaud dit Avocat, H. Yang, A. Nitsche, J. Wenger, B. L. Yoder and R. Signorell*

16980



Tracking protein–protein interactions by NMR: conformational selection in human steroidogenic cytochrome P450 CYP17A1 induced by cytochrome b_5

Alaina M. Richard, D. Fernando Estrada, Liam Flynn, Susan Sondej Pochapsky, Emily E. Scott and Thomas C. Pochapsky*

16989

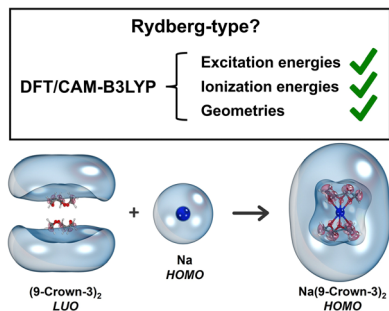

Electronic structure analysis and DFT benchmarking of Rydberg-type alkali-metal-crown ether, -cryptand, and -adamantane complexes

Isuru R. Ariyaratna

16998

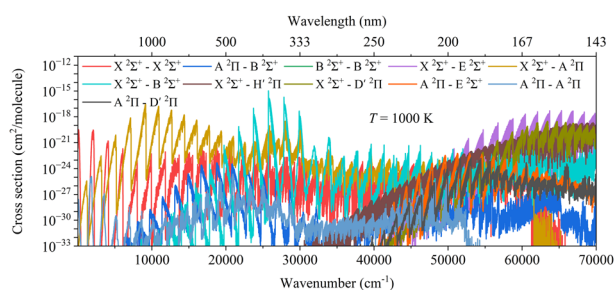

An *ab initio* diabatic study of rovibronic spectra of CN

Shuai Zhang, Zhi Qin and Linhua Liu*



RESEARCH PAPERS

17011

Exploring transmembrane allostery in the MexB: DB08385 variant as a promising inhibitor-like candidate against *Pseudomonas aeruginosa* antibiotic resistance: a computational study

Abhishek Bera, Shreya Mukherjee and Niladri Patra*

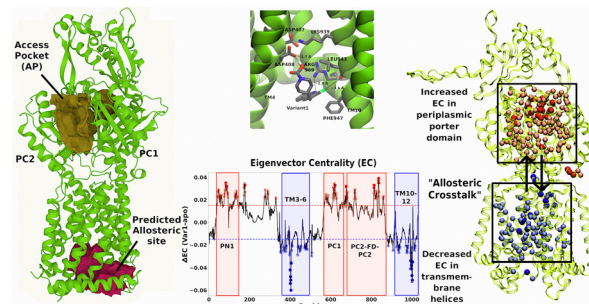

17028

Coupled-cluster treatment of complex open-shell systems: the case of single-molecule magnets

Maristella Alessio,* Garrette Pauley Paran, Cansu Utku, Andreas Grüneis and Thomas-C. Jagau

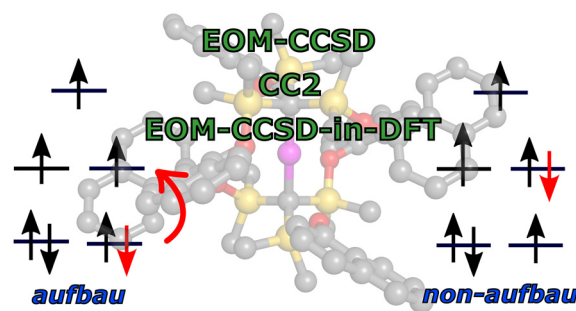

17042

Photoelectron spectrum of the pyridyl radical

Emil Karaev, Marius Gerlach, Katharina Theil, Gustavo A. Garcia, Christian Alcaraz, Jean-Christophe Loison and Ingo Fischer*

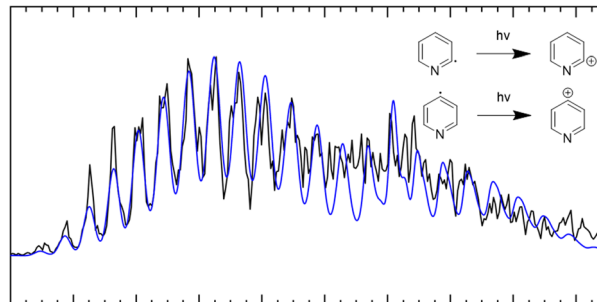

17048

Evaluating the contributions to conductivity in room temperature ionic liquids

Emily D. Simonis and G. J. Blanchard*

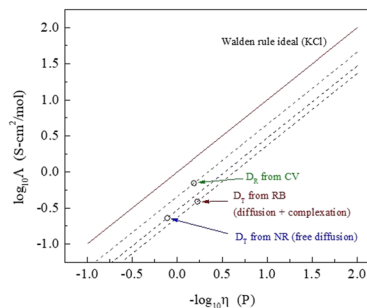

17057

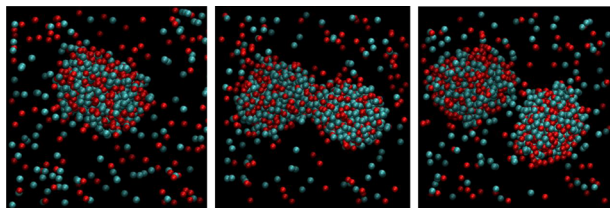

Secondary nucleation in symmetric binary SALR mixtures

Jiazheng Tan and Martin B. Sweatman*

17065

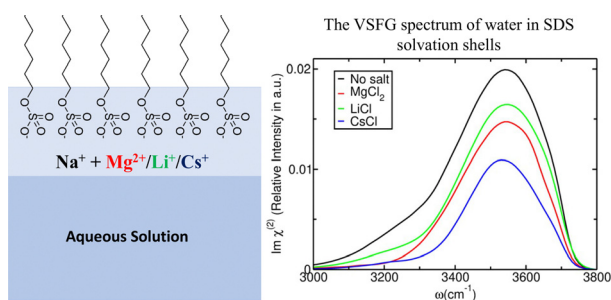

Effect of counterions on the structure and dynamics of water near a negatively charged surfactant: a theoretical vibrational sum frequency generation study

Ravi Malik, Shinji Saito* and Amalendu Chandra*

17075

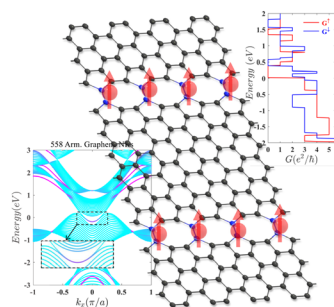

Topological phases, local magnetic moments, and spin polarization triggered by C₅₅₈-line defects in armchair graphene nanoribbons

Ning-Jing Yang, Wen-Ti Guo, Hai Yang, Zhigao Huang and Jian-Min Zhang*

17083

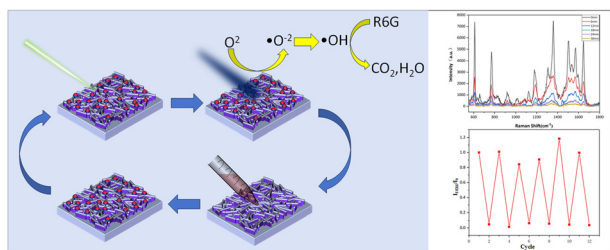

Ag/ZnO microcavities with high sensitivity and self-cleaning properties for fast repetitive SERS detection

Jiale Zheng, Dongliang Liu, Xilong Liu, Zekai Wang, Junfeng Li, Xinxin Wang, Jun Wang, Qiang Fu, Yanqiang Cao, Liyong Jiang and Yikai Chen*



17090

Theoretical study of the spin–orbit coupled molecular states of the Mg–He dimer

K. Alioua

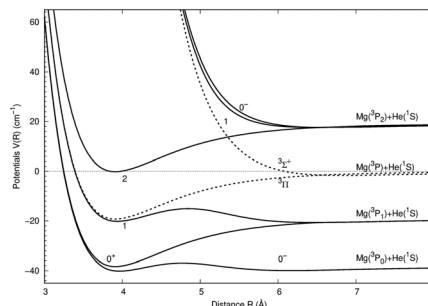

17102

A multi-dimensional photodetector based on an $\alpha\text{-MoO}_3$ grating and graphene

Yating Wang, Mingjun Wang,* Haotuo Liu, Biyuan Wu, Xinyue Wang and Xiaohu Wu*

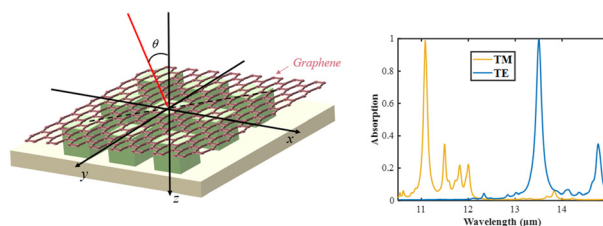

17110

Exploring Si-centered phthalocyanine as a single atom catalyst for N_2O reduction: a DFT study

Adnan Ali Khan,* Sarah Abdullah Alsalhi* and Ata Ur Rahman

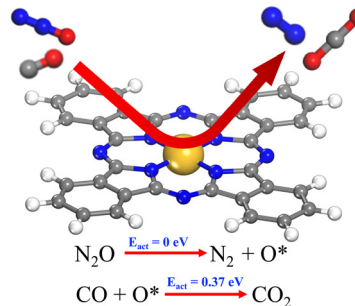

17118

Adsorption and solar light activity of noble metal adatoms (Au and Zn) on Fe(111) surface: a first-principles study

Qaiser Rafiq, Muhammad Tahir Khan,* Sardar Sikandar Hayat,* Sikander Azam,* Amin Ur Rahman, Hosam O. Elansary and Muhammad Shan

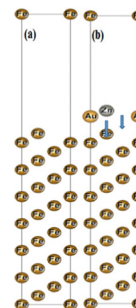

17132

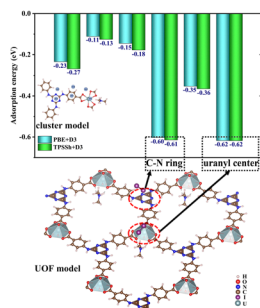

Iodine capture of a two-dimensional layered uranyl-organic framework: a combined DFT and AIMD study

Mingyang Shi, Kunyang Cheng, Xiujuan Cheng, Xuying Zhou, Gang Jiang and Jiguang Du*

17141

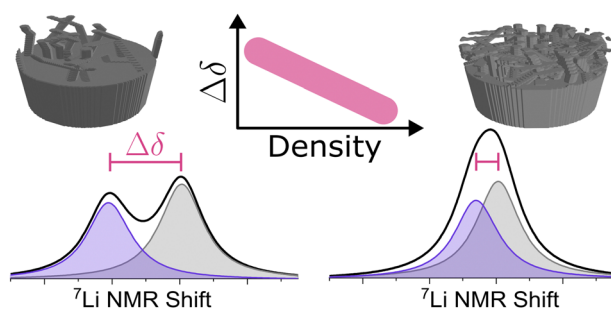

Morphology characterization of dendrites on lithium metal electrodes by NMR spectroscopy

Santiago Agustín Maldonado-Ochoa,* Muriel Zampieri, Manuel Otero and Fabián Vaca Chávez*

17148

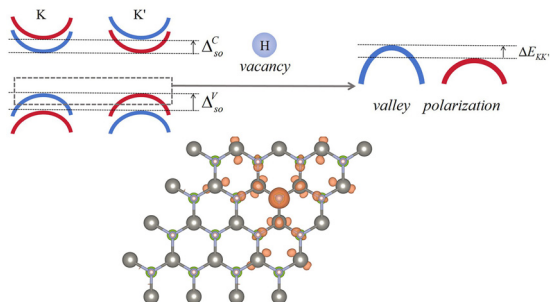

Large valley splitting and vacancy-induced valley polarization in two-dimensional WSeNH

Ziqi Wang, Xuening Han and Yan Liang*

17155

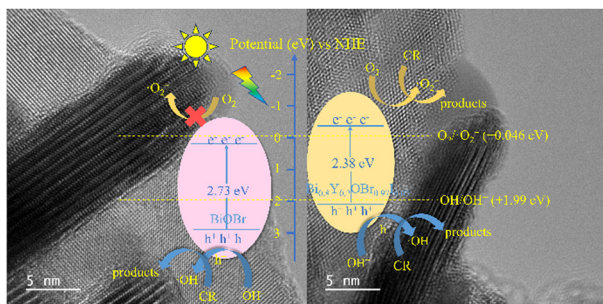

Enhancing the adsorption-photocatalytic efficiency of BiOBr for Congo red degradation by tuning the surface charge and bandgap via an Y^{3+} - I^{-} co-doping strategy

Dongsheng Chen, Keqian Gong, Xiangyang Xu,* Chenyu Huang and Pengtao Lei



RESEARCH PAPERS

17171

Disclosure of the nano-scale hydrogen dynamics on mono-vacancy graphene: a reactivity study with incoming gases

Nasim Hassani

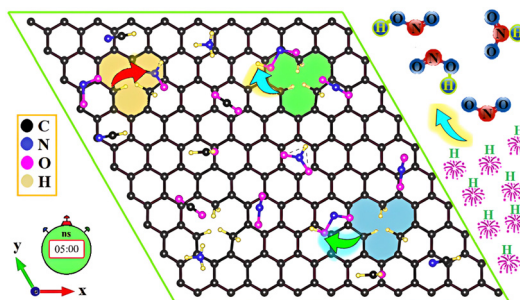

17182

ZnSeTe quantum dots modified with zinc chloride toward bright trap-state emission

Zhe-Yong Chen, Xue Ren, Hui-Ling Hu, Meng Liu, Yi Liu and Feng-Lei Jiang*

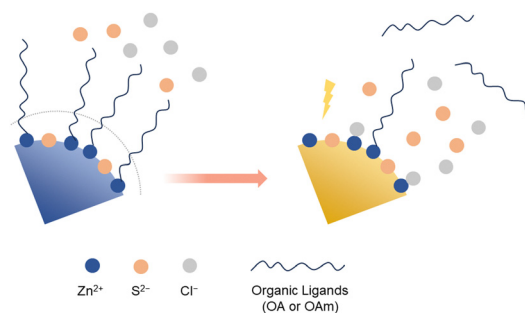

17191

Metallic CoSb and Janus Co₂AsSb monolayers as promising anode materials for metal-ion batteries

Dildar Ahmed, Nisar Muhammad and Z. J. Ding*

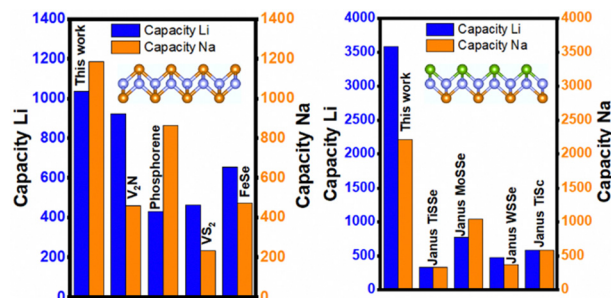

17205

Structural analysis of C₈H₆^{•+} fragment ion from quinoline using ion-mobility spectrometry/mass spectrometry

Kenichi Iwamoto,* Genki Inoue and Hiroshi Matsubara

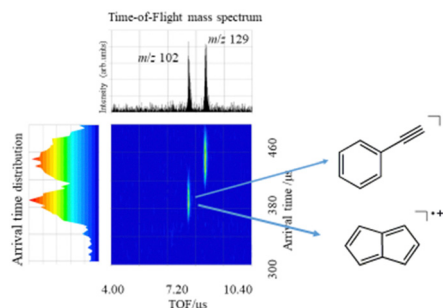

RESEARCH PAPERS

17213

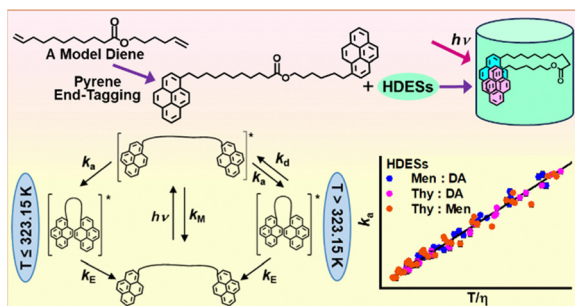

Assessing hydrophobic deep eutectic solvents for intramolecular excimer formation

Shreya Juneja and Siddharth Pandey*

17223

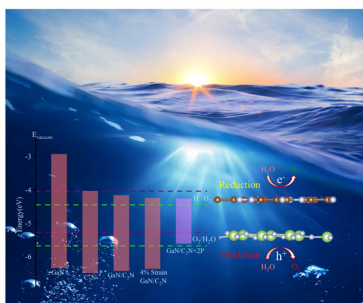
Doping and strain modulation of the electronic, optical and photocatalytic properties of the GaN/C₂N heterostructure

Fu Yin, Hui Wang,* Zhengqin Zhao, LiJia Luo, Yongliang Tang, Yanbo Zhang and Qiang Xue

17232

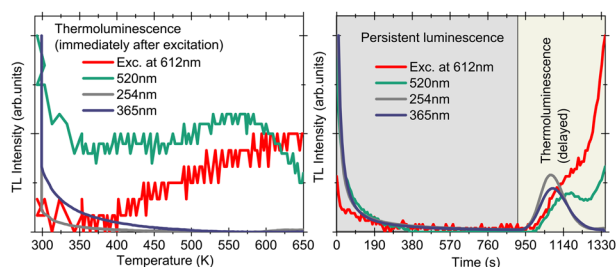
Delayed tunneling of charges to deep traps in a ZnO impurity containing Cr³⁺ doped Zn₂TiO₄ inverse spinel

Ankit Sharma and Suchinder K. Sharma*

17240

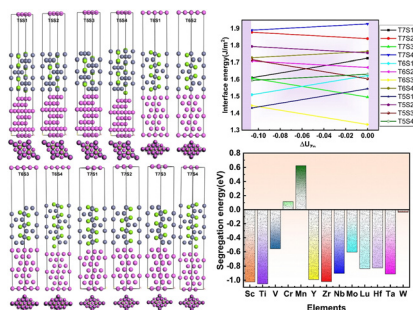
The first-principles study of interfacial bonding strength and segregation behavior of alloyed elements at the $\eta(\text{MgZn}_2)/\text{Al}$ interface

Qing Gao, Guoyu Qiao, Weibing Wang, Yuxiang Ge, Junqiang Ren, Wei Li, Ping Yang, Xuefeng Lu* and Jisen Qiao*



17255

The SCAN+*U* method in the investigation of complex transition metal oxides: a case study on $\text{YSr}_2\text{Cu}_2\text{FeO}_{7+\delta}$ ($\delta = 0, 1$)

Marianela Gómez-Toledo and Elena M. Arroyo-de Dompablo*

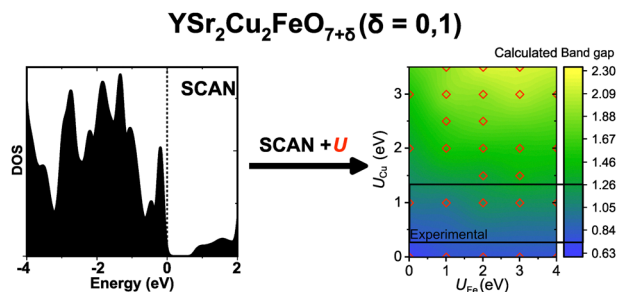

17265

Importance sampling within configuration space integration for adsorbate thermophysical properties: a case study for $\text{CH}_3/\text{Ni}(111)$

Katrin Blöndal, Kirk Badger, Khachik Sargsyan, David H. Bross, Branko Ruscic and C. Franklin Goldsmith*

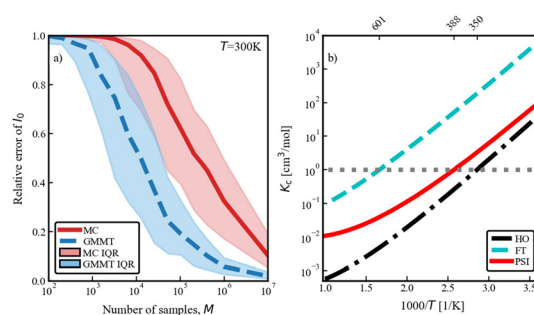

17274

Preferential segregation of gold at the symmetrical tilt grain boundaries of platinum: an atomic-scale quantitative understanding

Xianxian Zhang, Jianfeng Tang,* Xingming Zhang, Liang Wang, Dingwang Yuan, Huiqiu Deng and Lei Deng*

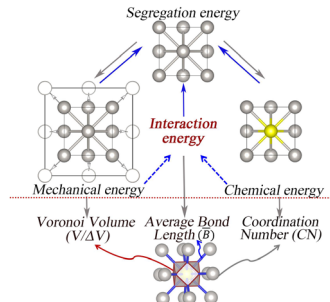

17282

Enhanced near-infrared optical transmission in zinc germanium phosphide crystals via precise magnesium doping

Shichao Cheng, Xueyan Zhang, Xiangran Kong, Tao Liu, Jingdong Yan, Tetiana Prikhna, Yunfei Shang,* Zuotao Lei* and Chunhui Yang

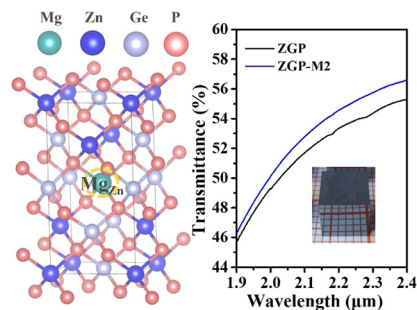

17292

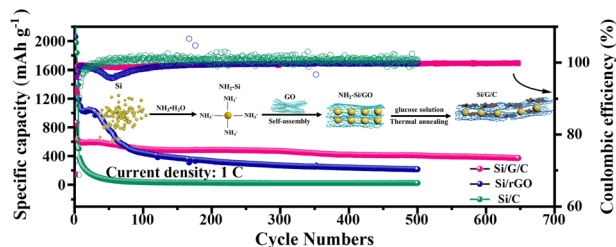

Carbon-coated silicon/graphite oxide composites as anode materials for highly stable lithium-ion batteries

Lujie Niu, Rui Zhang,* Qiang Zhang, Dong Wang, Yanlei Bi, Guangwu Wen and Lu-Chang Qin

17303

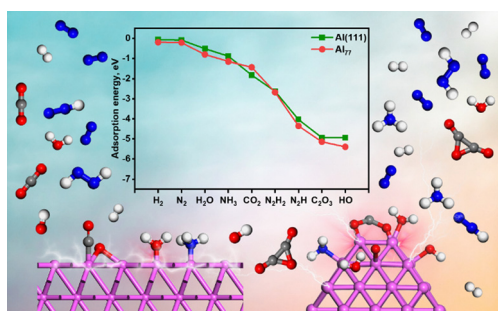

Adsorption mechanisms of decomposition species of CHON-containing explosives on aluminum surfaces

Kai Zhong and Chaoyang Zhang*

17315

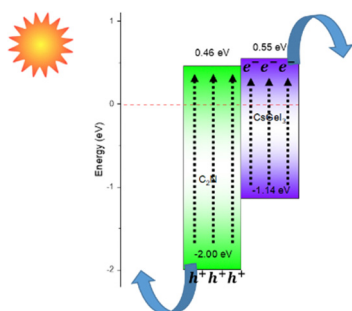

The lead-free perovskite-based heterojunction C₂N/CsGeI₃: an exploration for superior visible-light absorption

Junli Chang,* Yumeng Xie, Wenwu Shi, Jinguo Jiang, Hongyan Zhang and Guangzhao Wang*

17324

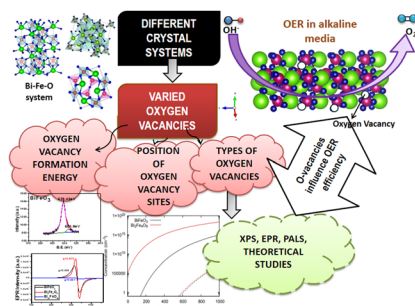

Electrocatalytic OER behavior of the Bi-Fe-O system: an understanding from the perspective of the presence of oxygen vacancies

Shaswati Jyoti, Aditi Vijay, Umberto Terranova, Santosh K Gupta, Kathi Sudarshan and Sonalika Vaidya*



17334

Modelling the growth reaction pathways of zinc-oxide ALD/MLD hybrid thin films: a DFT study

Mario Mäkinen,* Timo Weckman and Kari Laasonen

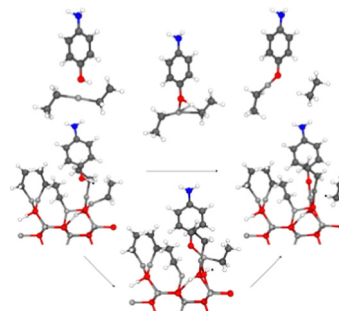

17345

Unravelling the effects of functional groups on the adsorption of 2-mercaptobenzothiazole on a copper surface: a DFT study

Thanh Hai Pham, Viorel Chihaiia and Do Ngoc Son*

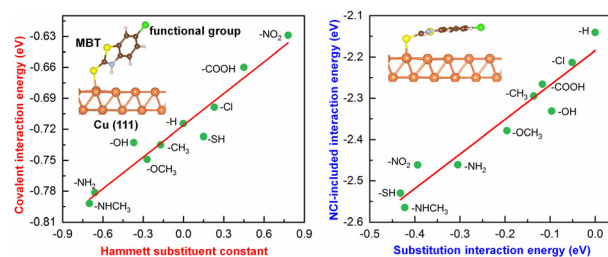

17359

Structural identification of single boron-doped graphdiynes by computational XPS and NEXAFS spectroscopy

Hai-Bo Li, Jun-Rong Zhang,* Xiu-Neng Song, Chuan-Kui Wang, Weijie Hua and Yong Ma*

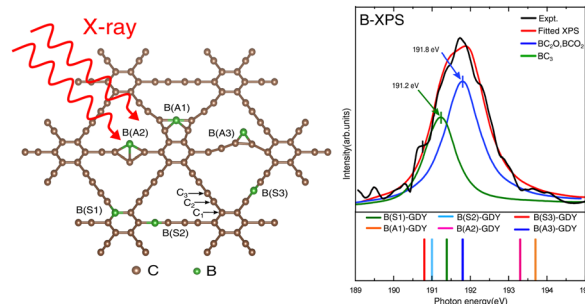

17370

Revisiting the quasi-aromaticity in polynuclear metal chalcogenide clusters and their derivative "cluster-assembly" crystalline structures

Bochu Wang and Wan-Lu Li*

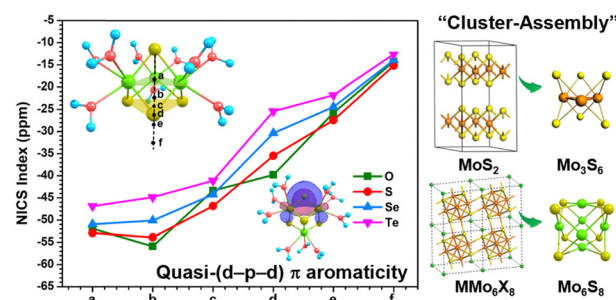

17383

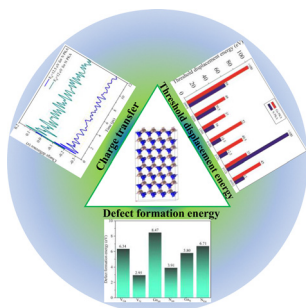

A combined AIMD and DFT study of the low-energy radiation responses of GaN

Ming Jiang,* Nuo Cheng, Xin-Yu Zhu, Xuan-Liang Hu, Zi-Han Wang, Ning Liu, Shuo Song, Sheng-Ze Wang, Xu-Sheng Liu* and Chandra Veer Singh*

17396

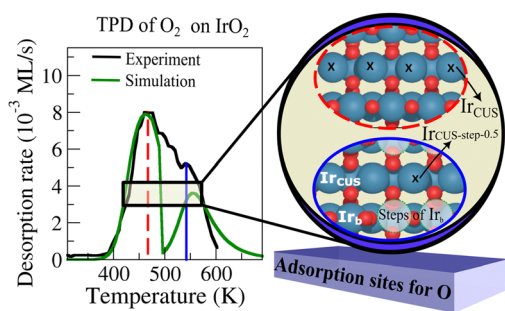

Characterization of adsorption sites on IrO₂ via temperature programmed O₂ desorption simulations

Vivianne K. Ocampo-Restrepo, Sudarshan Vijay, G. T. Kasun Kalhara Gunasooriya and Jens K. Nørskov*

