

# Nanoscale Horizons

The home for rapid reports of exceptional significance in nanoscience and nanotechnology  
[rsc.li/nanoscale-horizons](https://rsc.li/nanoscale-horizons)

The Royal Society of Chemistry is the world's leading chemistry community. Through our high impact journals and publications we connect the world with the chemical sciences and invest the profits back into the chemistry community.

## IN THIS ISSUE

ISSN 2055-6756 CODEN NHAOAW 9(9) 1381-1590 (2024)



### Cover

See Pawet Piotr Michałowski, pp. 1493-1497. Image reproduced by permission of Łukasiewicz Research Network - Institute of Microelectronics and Photonics from *Nanoscale Horiz.*, 2024, 9, 1493.

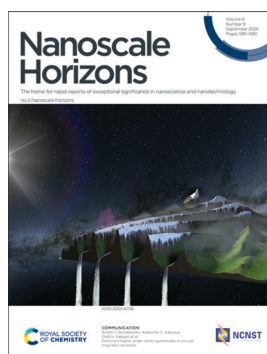

### Inside cover

See Artem V. Bondarenko, Adekunle O. Adeyeye, Gleb N. Kakazei *et al.*, pp. 1498-1505. Image reproduced by permission of Artem V. Bondarenko and Gleb N. Kakazei from *Nanoscale Horiz.*, 2024, 9, 1498.

## EDITORIAL

1389

### Outstanding Reviewers for *Nanoscale Horizons* in 2023

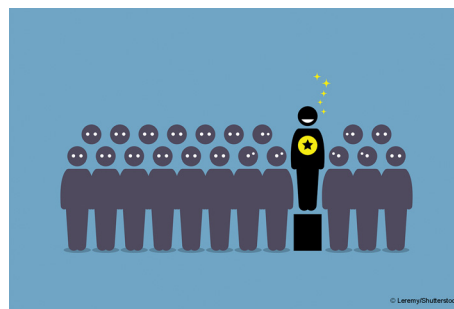

## REVIEWS

1390

### Advancements in molecular disassembly of optical probes: a paradigm shift in sensing, bioimaging, and therapeutics

Karolina Saczuk, Marta Dudek, Katarzyna Matczyszyn and Marco Deiana\*

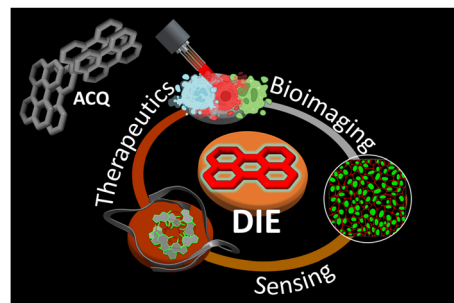

# RSC Applied Interfaces

GOLD  
OPEN  
ACCESS

Interfacial and surface research  
with an applied focus

Interdisciplinary and open access



[rsc.li/RSCApplInter](http://rsc.li/RSCApplInter)

Fundamental questions  
Elemental answers

## REVIEWS

1417

### Innovations of metallic contacts on semiconducting 2D transition metal dichalcogenides toward advanced 3D-structured field-effect transistors

Byeongchan Kim, Seojoo Lee and Jin-Hong Park\*

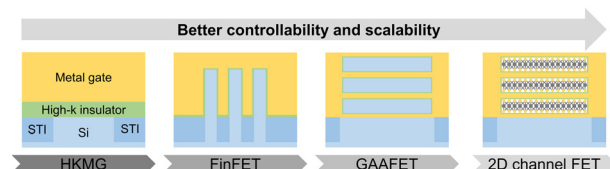

1432

### Multi-metallic MOF based composites for environmental applications: synergizing metal centers and interactions

Wei Wang, Bergoi Ibarlucea, Chuanhui Huang, Renhao Dong, Muhannad Al Aiti,\* Shirong Huang\* and Gianarelio Cuniberti\*

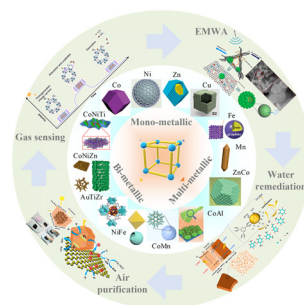

1475

### Review of neuromorphic computing based on NAND flash memory

Sung-Tae Lee\* and Jong-Ho Lee\*

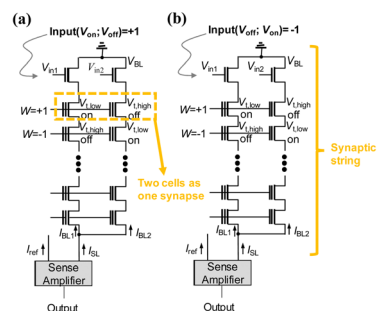

## COMMUNICATIONS

1493

### Unraveling the composition of each atomic layer in the MXene/MAX phase structure – identification of oxycarbide, oxynitride, and oxycarbonitride subfamilies of MXenes

Paweł Piotr Michałowski

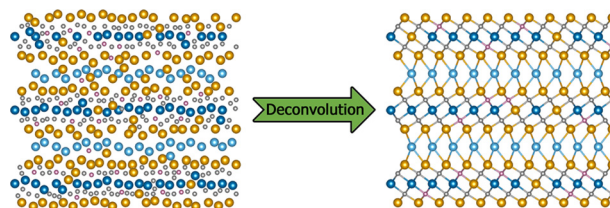



1498

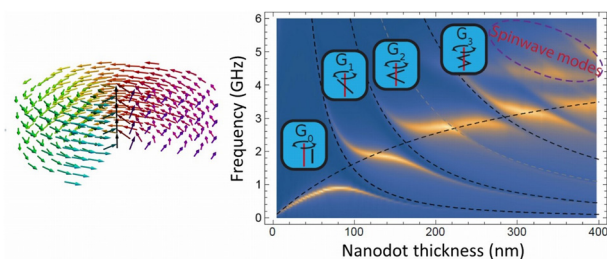

### Dominant higher-order vortex gyromodes in circular magnetic nanodots

Artem V. Bondarenko,\* Sergey A. Bunyaev, Amit K. Shukla, Arlete Apolinario, Navab Singh, David Navas, Konstantin Y. Guslienko, Adekunle O. Adeyeye\* and Gleb N. Kakazei\*

1506

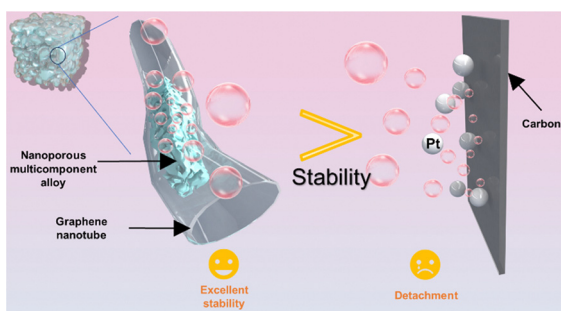

### Bubbling resilient 3D free-standing nanoporous graphene with an encapsulated multicomponent nano-alloy for enhanced electrocatalysis

Linshan Zhu, Qingqing Li, Yixuan Hu, Xin Wu, Kolan Madhav Reddy,\* Kaikai Li,\* Guoqiang Xie, Xingjun Liu and Hua-Jun Qiu\*

1514

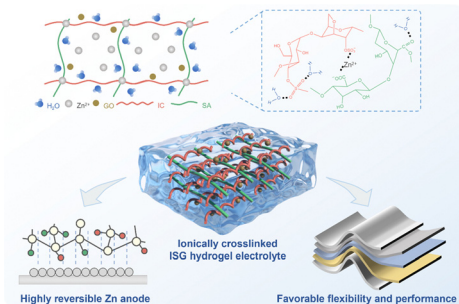

### An ionically cross-linked composite hydrogel electrolyte based on natural biomacromolecules for sustainable zinc-ion batteries

Haoyang Ge, Liping Qin,\* Bingyao Zhang, Long Jiang, Yan Tang, Bingan Lu, Siyu Tian\* and Jiang Zhou\*

1522

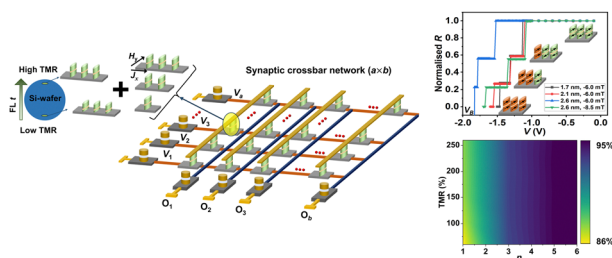

### Bimodal alteration of cognitive accuracy for spintronic artificial neural networks

Anuj Kumar, Debasis Das, Dennis J. X. Lin, Lisen Huang, Sherry L. K. Yap, Hang Khume Tan, Royston J. J. Lim, Hui Ru Tan, Yeow Teck Toh, Sze Ter Lim, Xuanyao Fong\* and Pin Ho\*



1532

### Insight into mechanism for remarkable photocatalytic hydrogen evolution of Cu/Pr dual atom co-modified TiO<sub>2</sub>

Hongshun Zheng, Baoye Zi, Tong Zhou, Guoyang Qiu, Zhongge Luo, Qingjie Lu, Alain Rafael Puente Santiago, Yumin Zhang, Jianhong Zhao, Jin Zhang, Tianwei He\* and Qingju Liu\*

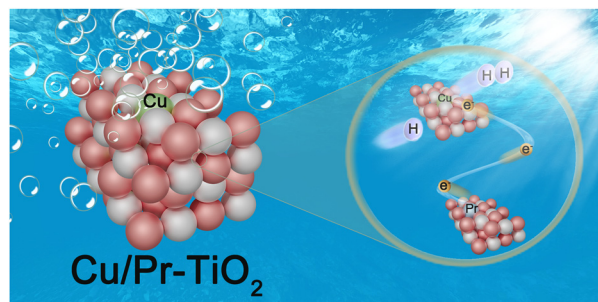

1543

### Biomimetic laser-induced graphene fern leaf and enzymatic biosensor for pesticide spray collection and monitoring

Nathan M. Jared, Zachary T. Johnson, Cicero C. Pola, Kristi K. Bez, Krishangee Bez, Shelby L. Hooe, Joyce C. Breger, Emily A. Smith, Igor L. Medintz, Nathan M. Neihart and Jonathan C. Claussen\*

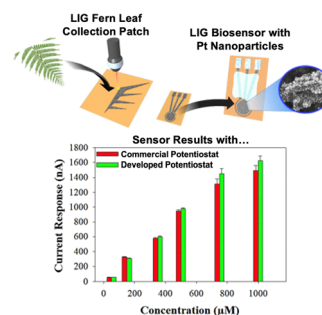

1557

### Mechanical regulation to interfacial thermal transport in GaN/diamond heterostructures for thermal switch

Xiaotong Yu, Yifan Li, Renjie He, Yanwei Wen, Rong Chen, Baoxing Xu\* and Yuan Gao\*

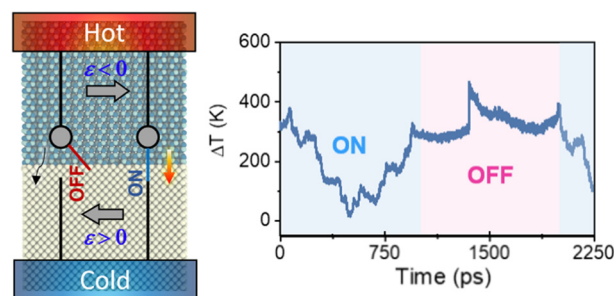

1568

### Colloidal TiO<sub>2</sub> nanocrystals with engineered defectivity and optical properties

Julia J. Chang, Bin Yuan, Sandro Mignuzzi, Riccardo Sapienza, Francesco Mezzadri and Ludovico Cademartiri\*

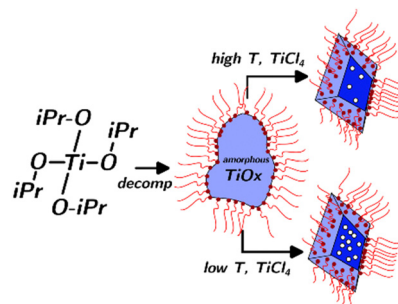

1574

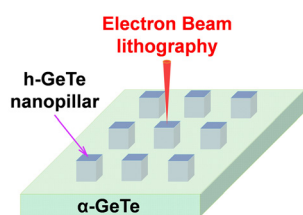
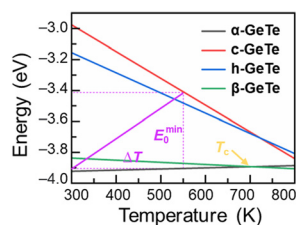

### Electron beam lithography of GeTe through polymorphic phase transformation

Hu Zhang, Meng Li, Shao-Bo Mi,\* Shao-Dong Cheng, Lu Lu and Zhi-Gang Chen\*

1582

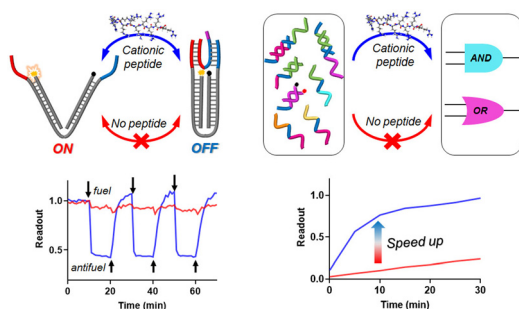

### Enhancing DNA-based nanodevices activation through cationic peptide acceleration of strand displacement

Xianxue Zhang, Ruikai Du, Shichao Xu, Xinyue Wang and Zhen-Gang Wang\*

1587

### Correction: Supramolecular nanocapsules as two-fold stabilizers of outer-cavity sub-nanometric Ru NPs and inner-cavity ultra-small Ru clusters

Ernest Ubasart, Irene Mustieles Marin, Juan Manuel Asensio, Gabriel Mencia, Ángela M. López-Vinasco, Cristina García-Simón, Iker del Rosal, Romuald Poteau,\* Bruno Chaudret\* and Xavi Ribas\*

