

IN THIS ISSUE

ISSN 0267-9477 CODEN JASPE2 40(1) 1–316 (2025)



Cover

See Yuzhu Liu, Jozef Lengyel *et al.*, pp. 114–121. Image reproduced by permission of Jun Feng, Yihui Yan and Yuzhu Liu from *J. Anal. At. Spectrom.*, 2025, **40**, 114. Image partly generated using BRIA AI.

ATOMIC SPECTROMETRY UPDATES

11

Atomic spectrometry update – a review of advances in environmental analysis

Warren R. L. Cairns, Owen T. Butler,* Olga Cavoura, Christine M. Davidson, José-Luis Todolí-Torró and Marcus von der Au



Atomic Spectrometry Updates



TUTORIAL REVIEW

70

Insights into the role of transition and noble metals mediating photochemical vapor generation

Ralph E. Sturgeon,* Enea Pagliano, Gisele S. Lopes, Renato S. A. Neto and Jane K. S. Brito

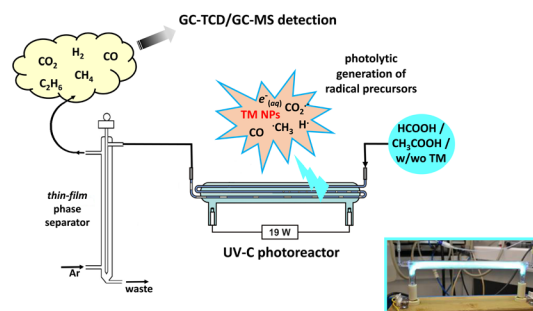

RSC Applied Polymers

GOLD
OPEN
ACCESS

The application of polymers,
both natural and synthetic

Interdisciplinary and open access

rsc.li/RSCApplPolym

Fundamental questions
Elemental answers

98

Chemical analysis of Chang'e-5 lunar soil using LA-ICP-MS in highly diluted fused glass discs

Shitou Wu,* Dingshuai Xue, Yueheng Yang, Hao Wang, Chunlai Li and Fuyuan Wu

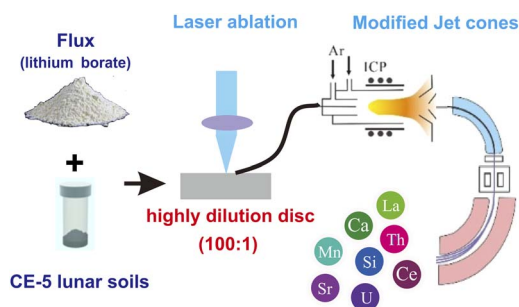

104

A new calcite reference material for *in situ* oxygen isotope analysis using secondary ion mass spectrometry: development and application constraints

Xuna Yin, Miaohong He,* Le Zhang,* Wenfeng Deng, Yangrui Guo, Zexian Cui, Qing Yang, Yanqiang Zhang and Gangjian Wei

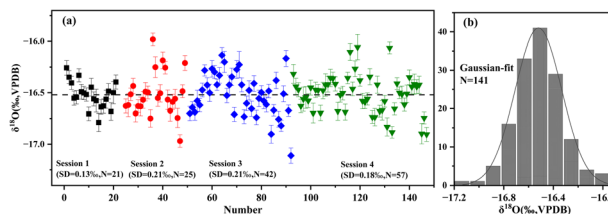

110

Ultra-trace elemental determination of Si by means of graphite furnace-atomic absorption spectrometry

Annika Schulze, Maximilian von Bremen-Kühne,* Philipp Albert, Christoph Krösche and Cornel Venzago

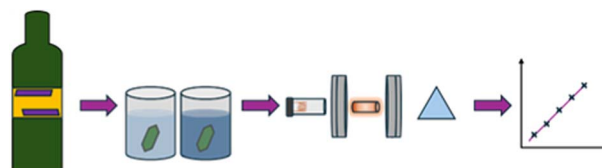

Si, leached from coated glass into food contact simulants, analyzed by GF-AAS. LOQ = 0.2 µg/L.

114

A simple method for elemental analysis of liquids in sprayed microdroplets by laser-induced breakdown spectroscopy

Jun Feng, Yihui Yan, Yuzhu Liu* and Jozef Lengyel*

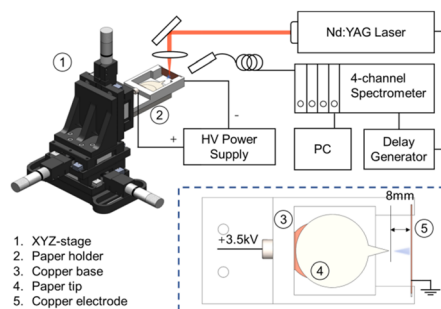

1. XYZ-stage
2. Paper holder
3. Copper base
4. Paper tip
5. Copper electrode



122

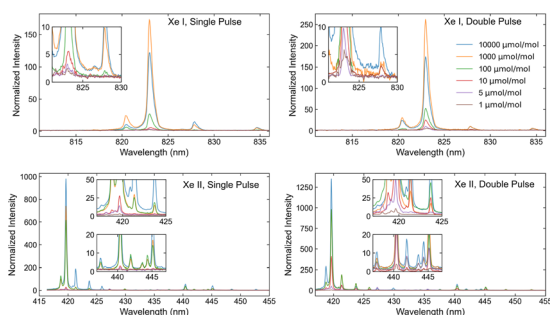

Trace xenon detection in ambient helium by double-pulse laser-induced breakdown spectroscopy

L. Garrett,* M. Burger, Y. Lee, H. Kim, P. Sabharwall, S. Choi and I. Jovanovic

130

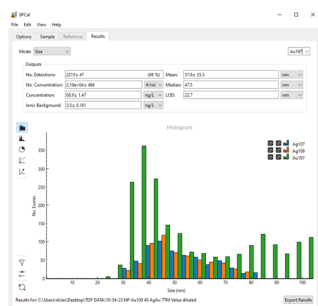

SPCal – an open source, easy-to-use processing platform for ICP-TOFMS-based single event data

Thomas E. Lockwood, Lukas Schlatt and David Clases*

137

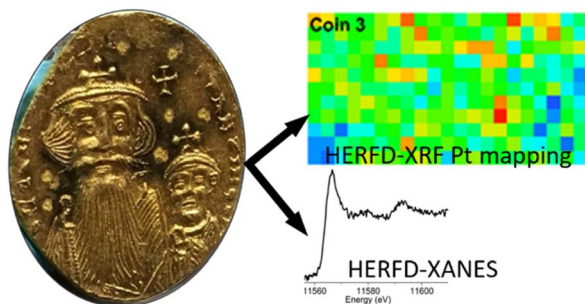

Finding a needle in a haystack: quantitative HERFD-XRF imaging and HERFD-XANES characterization of trace platinum in gold solidi from the Late Roman and Byzantine Empires

Lisa L. Van Loon,* Y. Zou Finfrock, Debora M. Meira, R. W. Burgess, George Bevan and Neil R. Banerjee

146

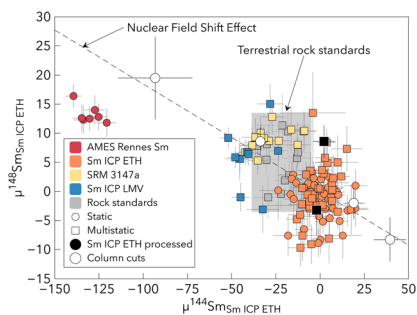

High-precision Sm isotope analysis by thermal ionisation mass spectrometry for large meteorite samples (>1 g)

Paul Frossard,* James M. J. Ball and Maria Schönbacher



162

A Gaussian spot overlap ablation model for prediction of aluminium alloy spectral peak intensity in high pulse repetition frequency LIBS

Dongming Qu, Bohao Su, Zhongshu Bai, Biye Liu, Xueying Jin, Guanyu Chen, Yuting Fu, Tingwen Gu, Guang Yang* and Qingkai Li*

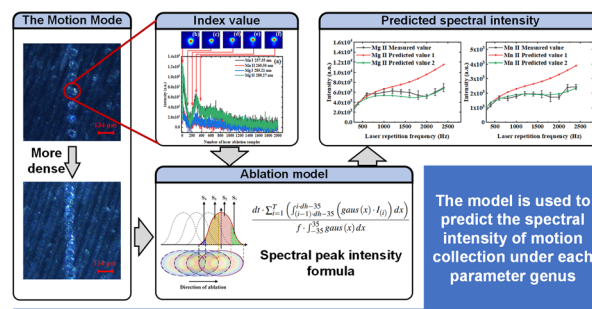

173

Development of a selective methodology for methylmercury quantification and evaluation of its accumulation in hippocampus

Marcelo Verdugo,* Ferdinand Ávila, Jhoel Ruiz, Constanza Vásquez, Nicole Roldán, M. Gabriela Lobos and Álvaro O. Ardiles

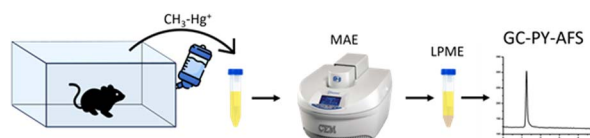

186

External electric field assisted laser-induced plasma and bubble dynamics for optimizing Mn₂O₃ nanoparticles as UV emitters

Sanchia Mae Kharphanbuh and Arpita Nath*

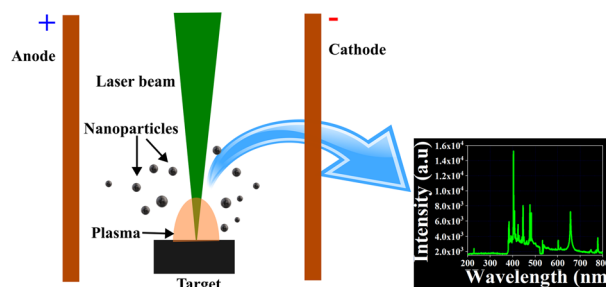

195

Rapid ²³⁵U/²³⁸U determination by matrix assisted ionization–time-of-flight mass spectrometry

Shelby Bowden,* Kyle M. Samperton, Elizabeth D. LaBone, Haley B. Lawton, Abigail M. Waldron, Joseph M. Mannion, Matthew S. Wellons and Danielle R. Mannion

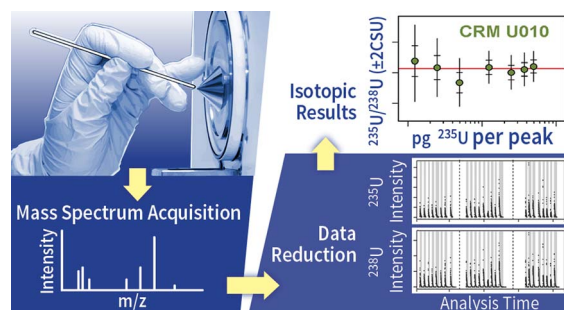

202

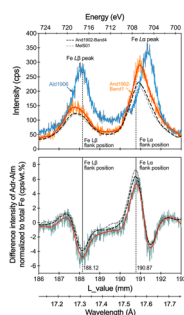

New natural garnet reference materials for determining the oxidation state of iron in garnet using the electron microprobe flank method

Yonghua Cao, Chang-Ming Xing,* Christina Yan Wang, Xianquan Ping and Xiaoju Lin

216

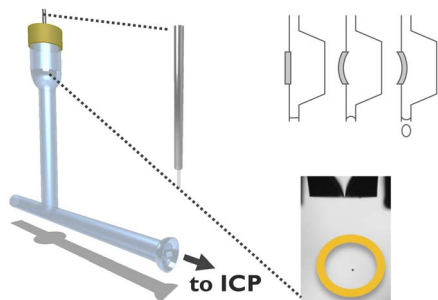

Quantitative elemental analysis of human leukemia K562 single cells by inductively coupled plasma mass spectrometry in combination with a microdroplet generator

Yu-ki Tanaka,* Hinano Katayama, Risako Iida and Yasumitsu Ogra

226

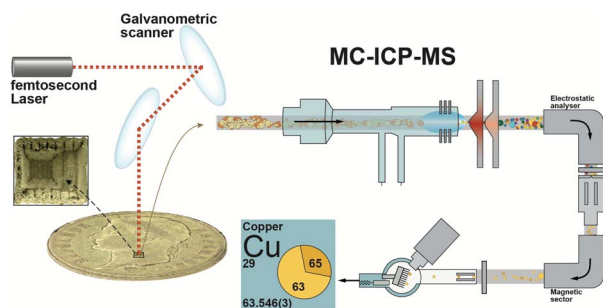

In situ copper isotope analysis by femtosecond laser ablation multicollector inductively coupled plasma mass spectrometry (fs-LA-MC-ICP-MS) on historical gold coins

Louise de Palaminy,* Franck Poitrasson, Christophe Pécheyran, Gaëlle Barbotin, Pascale Louvat, Sylvain Bérail, Anne-Laure Ronzani, Luc Robbiola and Sandrine Baron

238

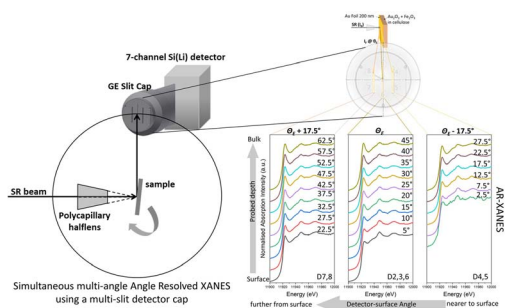

Simultaneous multi-angle AR-XANES for surface-sensitive chemical speciation of gold nanolayers in wall painting replica

Maram Na'es,* Lars Lühl, Daniel Grötzsch, Ioanna Mantouvalou, Jonas Baumann and Birgit Kanngießer



248

Vacuum degree detection performance improvement of vacuum switches based on NELIBS

Jiaqi Liu, Xiaokang Ding, Feilong Zhang, Huan Yuan,*
Xiaohua Wang,* Aijun Yang, Jifeng Chu and Mingzhe Rong

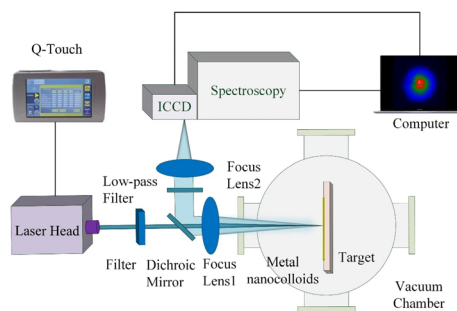

259

Bulk analysis of columbite ores by LA-ICP-MS: development of reference materials and investigation into matrix effects

Subramaniyan Balachandar, Wen Zhang,* Yongsheng Liu,
Zhaochu Hu, Haihong Chen, Tao Luo, Tao He
and Xianli Zeng

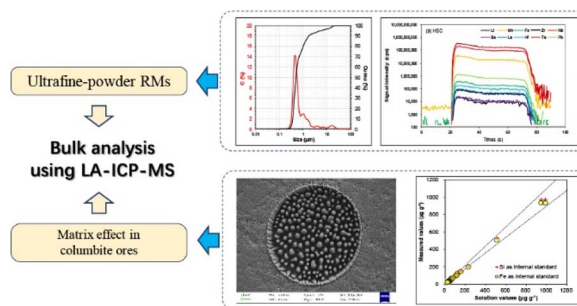

276

Quantitative sizing of microplastics up to 20 μm using ICP-TOFMS

Fazzolari Sandro, Hattendorf Bodo and Günther Detlef*

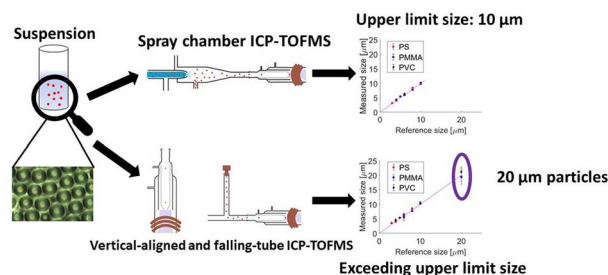

286

High-precision coal classification using laser-induced breakdown spectroscopy (LIBS) coupled with the CST-PCA-based ISSA-KELM

Shuaijun Li, Xiaojian Hao,* Biming Mo, Junjie Chen,
Hongkai Wei, Junjie Ma, Xiaodong Liang and Heng Zhang

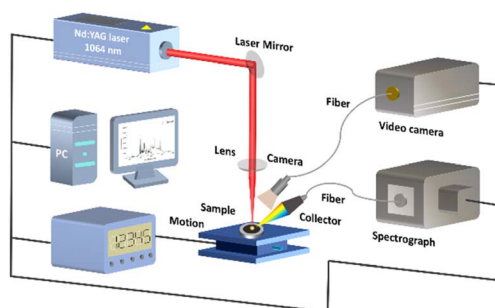

297

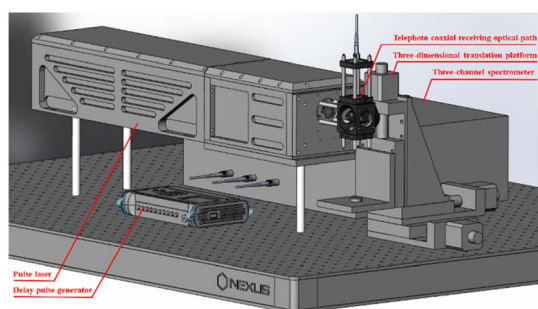

An accurate quantitative method for NdFeB magnetism based on laser-induced breakdown spectroscopy

Guanyu Chen, Jing Chen, Dongming Qu, Guang Yang* and Huihui Sun*

306

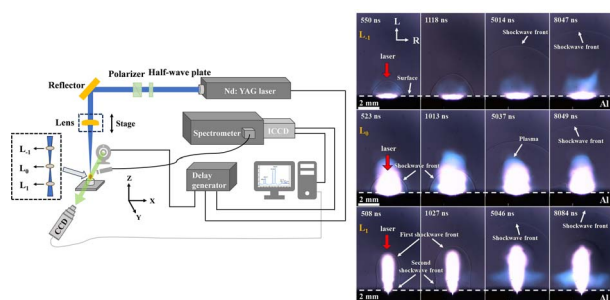

Influence of the distance between the focused point and Al surface on atomic and molecular emission spectra in air

Huihui Zhu, Bowen Fan, Yubo Zhang, Zhuo Wu, Fuli Chen, Xiaohui Su and Tao Lü*

