

Nanoscale Horizons

The home for rapid reports of exceptional significance in nanoscience and nanotechnology

rsc.li/nanoscale-horizons

The Royal Society of Chemistry is the world's leading chemistry community. Through our high impact journals and publications we connect the world with the chemical sciences and invest the profits back into the chemistry community.

IN THIS ISSUE

ISSN 2055-6756 CODEN NHAOAW 10(1) 1-192 (2025)



Cover

See Paolo Bergese *et al.*, pp. 104–112. Image reproduced by permission of Paolo Bergese and Annalisa Radeghieri from *Nanoscale Horiz.*, 2025, 10, 104.



Inside cover

See Taegyun Park, Cheol Seong Hwang *et al.*, pp. 113–123. Image reproduced by permission of Cheol Seong Hwang from *Nanoscale Horiz.*, 2025, 10, 113.

EDITORIALS

9

Understanding the relationship between nanosheet thickness and piezoresistivity in graphene strain sensors

Sara Domenici

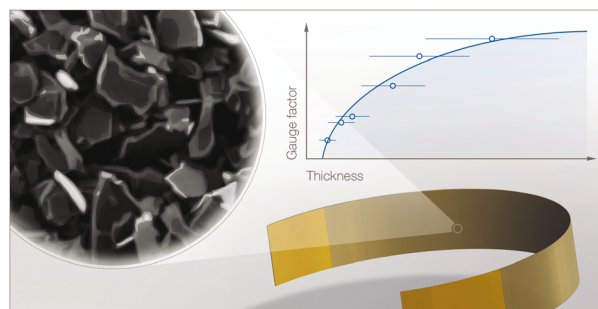

11

Reflecting on *Nanoscale Horizons* in 2024



Royal Society of Chemistry approved training courses

Explore your options.
Develop your skills.
Discover learning
that suits you.

**Courses in the classroom,
the lab, or online**

Find something for every
stage of your professional
development. Search our
database by:

- subject area
- location
- event type
- skill level

Members **get at least 10% off**

Visit rsc.li/cpd-training



**SAVE
10%**



16

Development of supported intermetallic compounds: advancing the Frontiers of heterogeneous catalysis

Yuan-Jun Song, Sijie Guo, Peng Xia, Fei Sun, Ze-Xian Chen, Shi-Han Yang, Xiao-Yang Zhang and Tong Zhang*

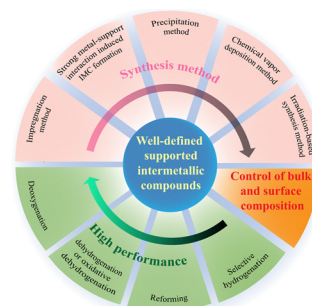

38

On the design of cell membrane-coated nanoparticles to treat inflammatory conditions

Andreia Marinho, Salette Reis and Cláudia Nunes*

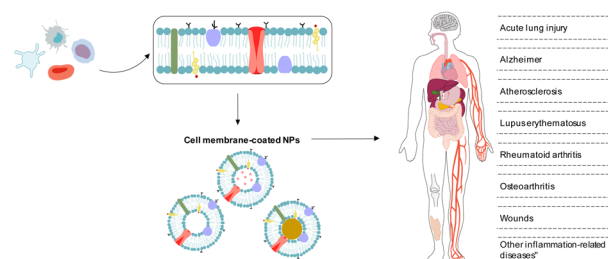

56

Semiconductor nanowire heterodimensional structures toward advanced optoelectronic devices

Xin Yan, Yao Li and Xia Zhang*

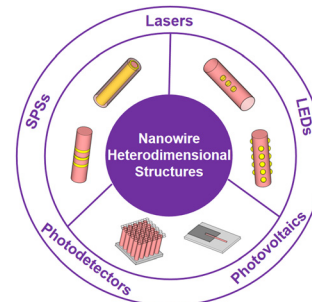

78

Theoretical insights and design of MXene for aqueous batteries and supercapacitors: status, challenges, and perspectives

Jun Zhao, Ninggui Ma, Tairan Wang, Yuhang Wang, Bochun Liang, Yaqin Zhang, Shuang Luo, Yu Xiong, Qianqian Wang and Jun Fan*

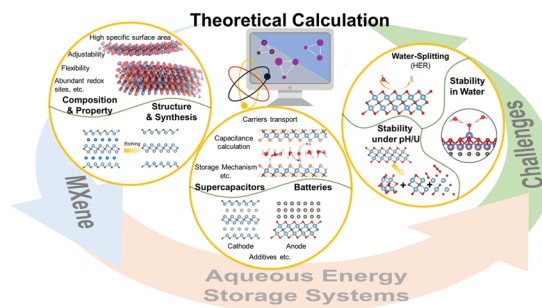

104

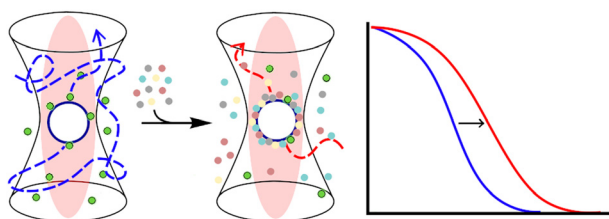

Extracellular vesicles of different cellular origin feature distinct biomolecular corona dynamics

Angelo Musicò, Andrea Zandrini, Santiago Gimenez Reyes, Valentina Mangolini, Lucia Paolini, Miriam Romano, Andrea Papait, Antonietta Rosa Silini, Paolo Di Gianvincenzo, Arabella Neva, Marina Cretich, Ornella Parolini, Camillo Almici, Sergio E. Moya, Annalisa Radeghieri and Paolo Bergese*

113

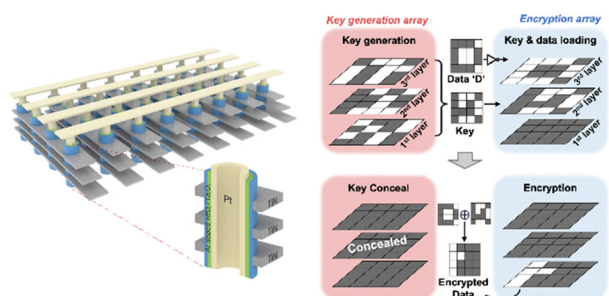

Concealable physical unclonable function generation and an in-memory encryption machine using vertical self-rectifying memristors

Jea Min Cho, Seung Soo Kim, Tae Won Park, Dong Hoon Shin, Yeong Rok Kim, Hyung Jun Park, Dong Yun Kim, Soo Hyung Lee, Taegyun Park* and Cheol Seong Hwang*

124

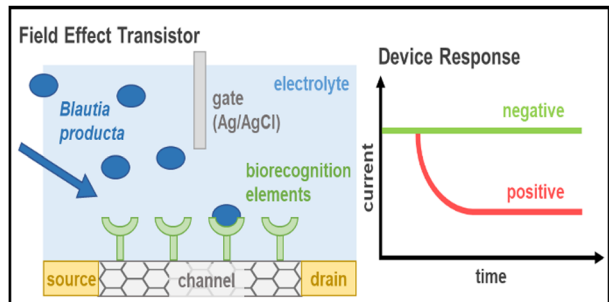

A *Blautia producta* specific gFET-based aptasensor for quantitative monitoring of microbiome quality

Hu Xing, Yiting Zhang, Runliu Li, Hans-Maximilian Ruzicka, Christopher Hain, Jakob Andersson, Anil Bozdogan, Marius Henkel, Uwe Knippschild, Roger Hasler, Christoph Kleber, Wolfgang Knoll, Ann-Kathrin Kissmann* and Frank Rosenau*

135

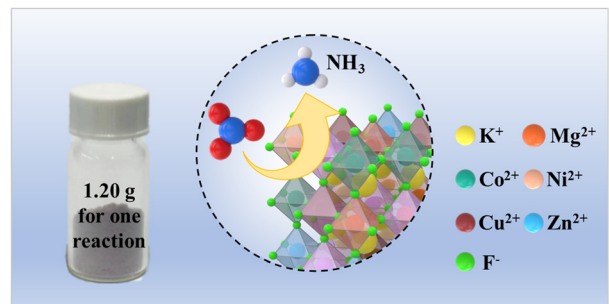

Polymer-confined synthesis of gram-scale high-entropy perovskite fluoride nanocubes for improved electrocatalytic reduction of nitrate to ammonia

Guohao Xue, Tianlu Wang, Hele Guo,* Nan Zhang, Claire J. Carmalt, Johan Hofkens, Feili Lai* and Tianxi Liu*



142

Lasing in an assembled array of silver nanocubes

Mindaugas Juodėnas,* Nadzeya Khinevich, Gvidas Klyvis, Joel Henzie, Tomas Tamulevičius and Sigitas Tamulevičius

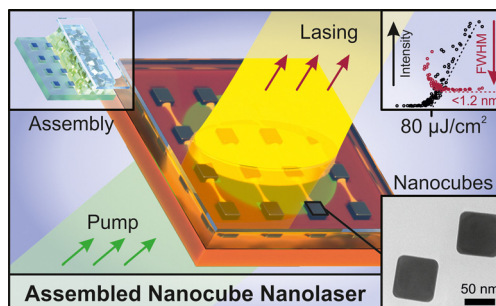

150

Correlated excitonic signatures of individual van der Waals NiPS₃ antiferromagnet nanoflakes

Vigneshwaran Chandrasekaran,* Christopher R. DeLaney, Cong Tai Trinh, David Parobek, Christopher A. Lane, Jian-Xin Zhu, Xiangzhi Li, Huan Zhao, Marshall A. Campbell, Laura Martin, Edward F. Wyckoff, Andrew C. Jones, Matthew M. Schneider, John Watt, Michael T. Pettes, Sergei A. Ivanov, Andrei Piryatinski, David H. Dunlap and Han Htoon*

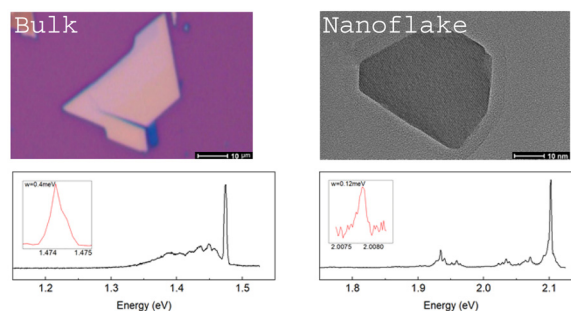

158

Full-color peptide-based fluorescent nanomaterials assembled under the control of amino acid doping

Yuhe Shen, Yulin Sun, Yaoyu Liang, Xiaojian Xu, Rongxin Su, Yuefei Wang* and Wei Qi*

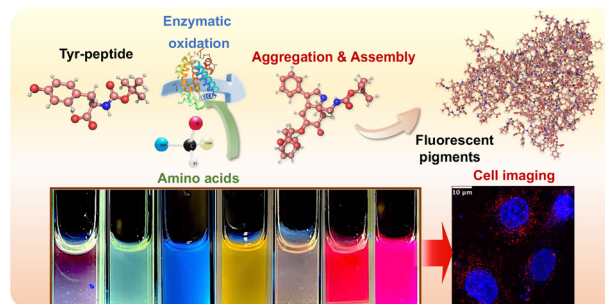

165

The near field response of molecules coupled with plasmons at atomistic resolution

Huijie He, Xueyang Zhen, Shuang Li, Sibing Chen and Xing Chen*

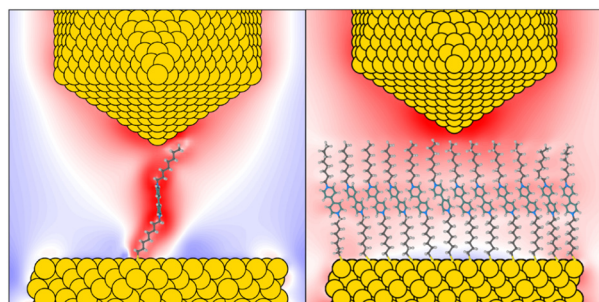

172

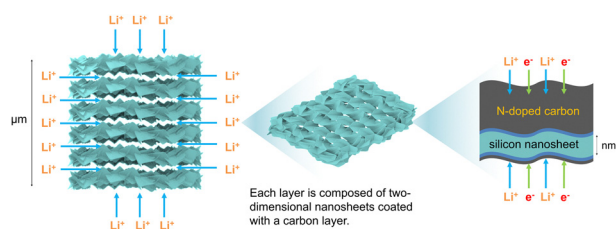

The well-defined three-dimensional matrix of a micro-sized silicon/carbon composite promoting lithium-ion transportation

Denghui Wang, Minghao Ma, Wenqiang Xu, Yingjie Ma,*
Lidong Li* and Xianglong Li*

179

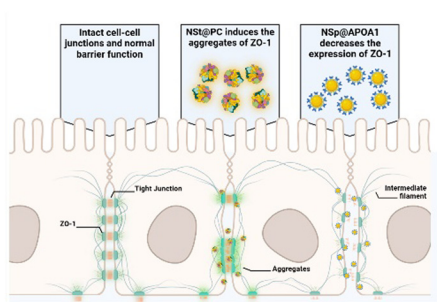

Protein corona potentiates the recovery of nanoparticle-induced disrupted tight junctions in endothelial cells

Muhammad Daniyal Ghouri, Ayesha Tariq,
Jabran Saleem, Abdul Muhaymin, Rong Cai* and
Chunying Chen*

