

Analytical Methods

Accepted Manuscript



This is an *Accepted Manuscript*, which has been through the Royal Society of Chemistry peer review process and has been accepted for publication.

Accepted Manuscripts are published online shortly after acceptance, before technical editing, formatting and proof reading. Using this free service, authors can make their results available to the community, in citable form, before we publish the edited article. We will replace this *Accepted Manuscript* with the edited and formatted *Advance Article* as soon as it is available.

You can find more information about *Accepted Manuscripts* in the [Information for Authors](#).

Please note that technical editing may introduce minor changes to the text and/or graphics, which may alter content. The journal's standard [Terms & Conditions](#) and the [Ethical guidelines](#) still apply. In no event shall the Royal Society of Chemistry be held responsible for any errors or omissions in this *Accepted Manuscript* or any consequences arising from the use of any information it contains.

COMMUNICATION

Portable and Amplicon Contamination Prevention Cartridge for DNA Amplification Coupled to Lateral Flow Detection

Cite this: DOI: 10.1039/x0xx00000x

Rui Wang,^a Fang Zhang,^a Zunzhong Ye,^a Jian Wu,^{a*} Liu Wang,^a Yuan Chen,^a Xiaofu Wang^b and Junfeng Xu^b

Received 00th January 2012,
Accepted 00th January 2012

DOI: 10.1039/x0xx00000x

www.rsc.org/

Right amount of oil sealed on the solution surface does not affect lateral-flow dipstick (LFD) detection. With this property, three types of enclosed and portable cartridges for DNA amplification coupled to LFD detection were realized to detect DNA amplicon specifically.

Nucleic acid detection has been increasingly important in the fields ranging from disease diagnosis to food safety inspection.^{1, 2} Currently, the DNA amplification methods include traditional PCR-based assays and emerging isothermal thermal amplification, such as cross-priming isothermal amplification (CPA), loop-mediated isothermal amplification (LAMP) and strand displacement amplification (SDA).^{3, 4} They have high amplification sensitivity and production yield. But due to the high yield of amplicon, these methods are faced with the problem of aerosol pollution seriously.

Moreover, for the detection of amplification products, traditional methods based on real-time fluorescent quantitative detection need to integrate optical equipment, which is not conducive to implementation and miniaturization.^{5, 6} Therefore, some researchers have been attempting to combine DNA amplification with many other detection means, like colorimetric detection, turbidity and electrochemical methods.⁶⁻¹⁸ Our group has developed a Pi-based colorimetric detection strip for DNA amplification. This technology is based on the color change from colorless to blue instead of color change from one to another, which made it more visible for naked eyes than traditional colorimetric means.¹⁹ Although to some extent, these approaches simplified the requirements for detection device, drawbacks still exist. For instance, some methods need uncapping operation, which is prone to cause aerosol pollution. Also some means are lack of detection sensitivity, causing the results difficult to judge.

According to our knowledge, no research up to now has reported on the DNA detection cartridge with portable and detection specificity. Recently, lateral-flow dipstick (LFD) method is popular. Its specificity is due to the design of capture probes and surface interactions of targeted molecules (see the Supporting Information, Figure S6).²⁰⁻²⁷ But current LFD cartridges for amplicon detection are complex, like commercial cartridge produced by Ustar Biotech Co. Ltd. and cartridge designed by Angelika Niemz group.²⁸ Therefore, it is pressing to develop more simple and low cost cartridges for DNA amplification coupled to LFD detection.

Here, we described three convenient and simple cartridges, in which both DNA amplification and detection can be conducted without the operation of uncapping. After DNA amplification, with only a simple reversed shake or gentle press, a visible readout can be obtained directly.

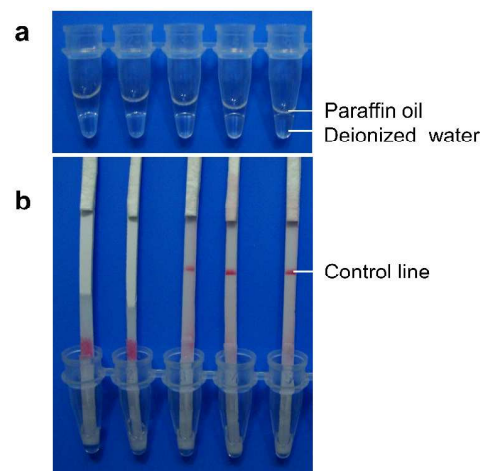

Figure 1 The effect of oil sealing on LFD detection. a) Different proportion of paraffin oil and deionized water. From left to right, respectively 2.5:1, 2:1, 1.5:1 1:1 and 0.5:1. The water volumes were all 25 µL. b) Visual results of LFD detection in 60 seconds.

For nucleic acid amplification and detection, once uncapping operation is conducted, there would be aerosol contamination. It is more serious in cross-priming isothermal amplification (CPA), in which the amplification efficiency is much higher resulting larger amounts of products.⁴ With our cartridges, the whole operation was cap-closed, which could avoid the contamination due to uncapping.

In our cartridges, oil sealing is needed to prevent water evaporation during DNA amplification. But no literature up to now has mentioned the impact of oil sealing on LFD detection. We have investigated the influence of different oil volume for sealing. As shown in figure 1, if oil was too much (image of the left two strips), it would affect the movement of reaction solution along the LFD strip. However, when reducing the quantity of oil, as the right two

strips shown, the visual read-out would appear quickly and generate deep color. It proved that appropriate quantity of oil would not affect LFD detection. While, if the oil was too little, it would not cover the reaction solution surface and fail to prevent evaporation. Before large batches of real sample detection, we have also tested the effect of sealing oil on reaction mixture detection after heating for an hour at 63 °C. The experimental results showed that, with the appropriate quantity of oil sealing, test line and control line generated quickly and clearly in positive samples, which verified the feasibility of oil sealing for nucleic acid amplification and detection (data not shown). For the appropriate volume of sealed oil, it should be as little as possible and cover the solution surface simultaneously. In this assay, the volume of sealing oil was 15 μ L for real sample detection.

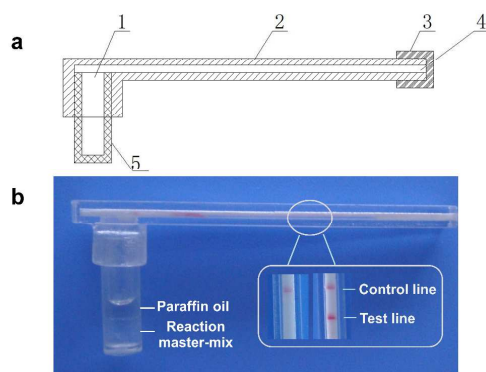

Figure 2 The horizontal type cartridge. a) 2D sketch of the cartridge structure: an interconnecting orifice (1) between the detection container (2) and reaction tube (5), an end cap (3) and a cavity for LFD strip (4). b) Cartridge for GM rice DNA detection. It contains 25 μ L reaction mixture with 15 μ L sealing paraffin oil in the reaction tube before amplification. The inset close-up showed detection results of no template control (left) and real sample of GM rice containing T-*Nos* component (right) with initial template of 750 copies.

To avoid aerosol contamination caused by uncapping operation, three types of disposable cartridges were designed. With our cartridges, the whole operation was cap-closed. Theoretically, there would be no aerosol contamination without the operation of uncapping. In fact, after three months of specific nucleic acid detection with the cartridges in our laboratory, there were no false positive results (details can be seen in supporting information, figure S5), which might prove the airtight property of our cartridges.

The cartridges were produced with 3D printing technology. Their components were low-cost and made of photosensitive resin. After printing, the components were polished with acetone vapor. For the size of cartridges, the inner diameter and height of the reaction tube were respectively 3 mm and 15 mm. In horizontal type cartridge, the volume of LFD container was 50 mm x 2 mm x 1 mm. Due to the small size of cartridges, integration of amplification and detection, it realized portable and miniaturization.

For the horizontal type cartridge, as shown in figure 2, it contains only three parts, including a reaction tube, a detection container (LFD container) on the top and an end cap (more details in Supporting Information, Figure S1). Before DNA amplification, LFD strip has been inserted to the LFD container and covered with the end cap. Then, 25 μ L prepared reaction solution is added to the reaction tube with 15 μ L paraffin oil sealing on the surface. The cartridge is completely sealed after assembled. Next, DNA amplification is carried out, like PCR or isothermal amplification. When amplification reaction is completed, turn the cartridge upside down and shake for several times. The reaction mixture will get in

touch with the LFD. Then it will migrate along the strip based on passive capillary action and produce a visual readout.^{24, 25, 29} All fluid remains sealed within the cartridge, eliminating possible amplicon carry-over contamination.

Besides the horizontal type cartridge, another LFD disposable cartridge looks like “injector” has also been designed. This cartridge consists of three parts including a reaction tube, a syringe outer tube wall and a syringe piston (more details in Supporting Information, Figure S3). LFD strip has been glued to the syringe piston. Similarly, 25 μ L DNA reaction mixture is prepared and added into reaction tube with right amount of paraffin oil for sealing. Then, assemble the cartridge and ensure it is fully sealed. During the reaction process, the dipstick should be hanging over the reaction mixture. After DNA amplification, press the syringe piston lightly and let the end of dipstick immerse into the DNA reaction mixture. According to the LFD detection theory (see the Supporting Information, Figure S5), a visible readout will be obtained directly.^{26, 27, 30-34}

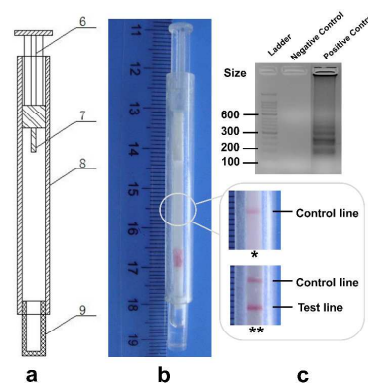

Figure 3 The “injector” cartridge. a) Perspective of the cartridge composition. 6, syringe piston; 7, small bulge for LFD strip gluing; 8, syringe outer tube wall; 9, reaction tube. b) Actual cartridge image and close-up results of initial T-*Nos* templates of 750 copies (**). c) Corresponding gel electrophoresis image of amplicon products. The ladder size was 50 bp.

Both of the two cartridges are feasible for DNA detection. But their operations are different, one is by the injection of LFD strip, the other is to let the solution flow to the test strip by reversed shaking operation. To test the performance of LFD cartridges, an isothermal thermal amplification method of CPA was employed for DNA detection.^{4, 35} In the CPA system, DNA amplification is conducted through strand displacements reaction. It is catalyzed by strand displacing DNA polymerase (Gsp Fast DNA polymerase) at a constant temperature. Particularly, because of the structure of primer sets, it will form intramolecular hairpin-like structures, which greatly contribute to the isothermal displacement of strands.^{4, 36} The practical sample was genetically modified (GM) rice Huahui 1 provided by Zhejiang Academy of Agricultural Sciences (Hangzhou, China). The cartridges were tested with initial template of 750 copies. The concentration of initial DNA template was estimated by spectrophotometry. A set of primers were designed to target *Agrobacterium tumefaciens* nopaline synthase terminator (T-*Nos*) gene in GM rice.³⁵ The primers comprised two displacement primers, two cross primers and two detector primers designed by Ustar Biotech Co., Ltd (see the Supporting Information, Figure S4).³⁶ The two detector primers were respectively labeled with fluorescein isothiocyanate (FITC) and biotin at 5' end of the sequence. Then, CPA reaction was carried out in assembled cartridges at 63 °C for 60 min in a thermal block (MSC-100 Thermo shaker, Hangzhou Allsheng Instruments CO. Ltd., Hangzhou, China). After amplification, LFD detection was conducted in different operation as

mentioned above. The visual readouts were shown in figure 2b and figure 3b. Then, the amplification products were also tested by gel electrophoresis (details can be seen in Supporting Information). As shown in figure 3c, the gel electrophoresis results were consistent with that in figure 3b. According to the results, it proved that DNA detection can be conducted in the two cartridges successfully without uncapping process.

Furthermore, we have found that non-oil sealed cartridge can be realized through reducing the interconnecting orifice between reaction tube and detection container in horizontal type cartridge (see the Supporting Information, Figure S2). Optimally, the shape of the orifice is round and the diameter is around 1.5 mm. To test the sensitivity of the cartridge, a batch of non-oil sealed cartridges were respectively injected with 50 μL prepared identical mixture and arranged to amplify simultaneously in a thermal block at 63 $^{\circ}\text{C}$ with no DNA template as control. The initial DNA template was 750 copies. Then, three replicates were carried out every time after amplification for respectively 10 min, 20 min, 40 min, 60 min and cooled in the refrigerator of 4 $^{\circ}\text{C}$ at the same time. After the whole amplification, shake the cartridges and make comparison of the detection results. As shown in figure 4, after amplification for 20 min, light positive readout was appeared. In comparison with fluorescent amplification curve of 750 copies (green triangle) in figure 5, we can see that the *T-Nos* gene can be detected by the non-oil sealed cartridge as soon as amplification happened. This result displayed the high sensitivity of the cartridge.

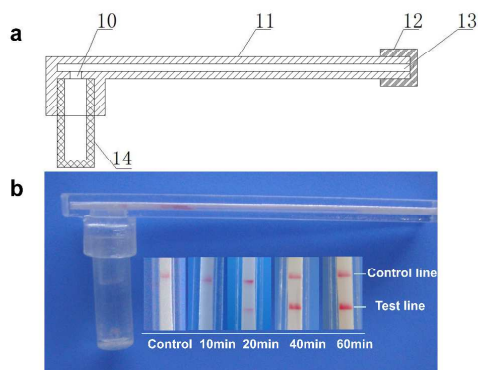

Figure 4 Non-oil sealed LFD cartridge. a) Cross-sectional schematic view of the cartridge. It is almost identical with the horizontal cartridge except for the smaller orifice (10). b) Actual cartridge image. Before DNA amplification, it contains 50 μL reaction mixture in the reaction tube. The close-up showed cartridges for real sample detection with initial template of 750 copies after amplification for respectively 10 min, 20 min, 40 min, 60 min with no template as control.

To further test the detection limitation of the cartridges, different copies of initial DNA templates were used to carry out CPA reaction in 63 $^{\circ}\text{C}$ for an hour with the three types of cartridges. SYTO 9-based real-time fluorescent CPA was employed as control. (details can be seen in Supporting Information). The experimental results showed that after detection for real samples with initial templates of 15, 150, 750, 1500 copies, the detection limitation of the three cartridges was all 150 copies, which was consistent with the results of real-time fluorescent CPA. Representatively, figure 5 showed the detection images of horizontal type cartridge for different initial templates ranging from 15 copies to 1500 copies. From figure 5, we could see that the cartridge detection results were consistent with that of fluorescent detection and further identified the detection reliability of the cartridges. Furthermore, from the melt curve in real-

time florescent CPA, the peak position was consistent in different positive samples, which proved that there was no nonspecific amplification and further verified the credibility of LFD cartridge detection (details can be seen in supporting information, figure S5).

Above all, the three cartridges were all feasible for DNA detection. For the optimal parameter, after comparing, the horizontal type cartridge was the best due to the reasons as following: 1) Oil sealing avoided water evaporation in the reaction tube, which made the amplification reaction be more complete. 2) Its operation was really simple, with only a reversed shaking operation.

In addition, this method is good for qualitative DNA detection because LFD has the advantage of high sensitivity and specificity. Non-specific results can be avoided during visual read-out detection. *T-Nos* gene can be tested once DNA is amplified, which shortens the whole detection time by one third. Combining this property of LFD with our enclosed cartridge, DNA can be tested specifically without the generation of cross-contamination.

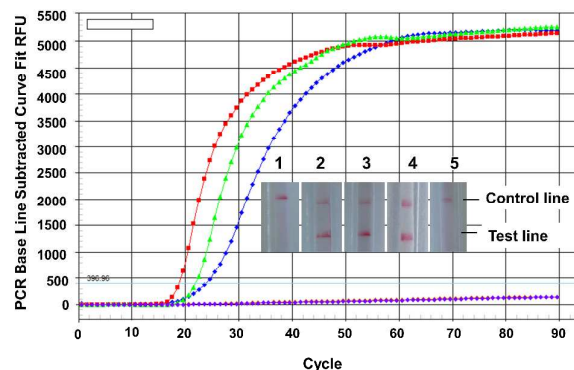

Figure 5 Detection limitation of the horizontal type cartridge for *T-Nos* detection with real-time fluorescent quantitative CPA as control. The initial *T-Nos* templates were respectively: red square (accordingly inset image 4), 1500 copies; green triangle (inset image 3), 750 copies; blue diamond (inset image 2), 150 copies; purple diamond (inset image 1), 15 copies; orange diamond (overlapped with purple diamond) (inset image 5), no template control.

In conclusion, the proposed cartridges have special advantages for their enclosed and portable properties. Specific DNA detection can be conducted with only a simple reversed shake or gentle press. Additionally, these cartridges can be used for many DNA amplification methods ranging from PCR-based assays to isothermal amplifications. Combining these cartridges with portable heating block, point-of-care detection can be achieved, especially in resource-limited area.

Acknowledgements

This work was supported by Synergistic Innovation Center of Modern Agricultural Equipment and Technology (NZXT01201402) and the Special Fund for Agro-Scientific Research in the Public Interest (Grant No. 201003008-5).

Notes and references

^a College of Biosystems Engineering and Food Science, Zhejiang University, Hangzhou 310058, China.

^b Institute of Agriculture Quality and Standard for Agro-products, Zhejiang Academy of Agricultural Sciences, Hangzhou 310021, China.

* (J.Wu) E-mail: wujian69@zju.edu.cn.

Tel.: 0086-571-88982180

†Electronic Supplementary Information (ESI) available: Experimental details and additional figures. See DOI: 10.1039/c000000x/

1. M. A. Dineva, L. Mahilum-Tapay and H. Lee, *Analyst*, 2007, **132**, 1193-1199.
2. T.-H. Kim, J. Park, C.-J. Kim and Y.-K. Cho, *Analytical chemistry*, 2014, **86**, 3841-3848.
3. L. Cui, Y. Ge, X. Qi, G. Xu, H. Li, K. Zhao, B. Wu, Z. Shi, X. Guo, L. Hu, Q. You, L.-H. Zhang, A. N. Freiberg, X. Yu, H. Wang, M. Zhou and Y.-W. Tang, *Journal of Clinical Microbiology*, 2012, **50**, 3881-3885.
4. R. Fang, X. Li, L. Hu, Q. You, J. Li, J. Wu, P. Xu, H. Zhong, Y. Luo and J. Mei, *Journal of clinical microbiology*, 2009, **47**, 845-847.
5. S. Tanriverdi, L. Chen and S. Chen, *Journal of Infectious Diseases*, 2010, **201**, S52-S58.
6. F. Zhang, J. Wu, R. Wang, L. Wang and Y. Ying, *Chemical Communications*, 2014, **50**, 8416-8419.
7. M. U. Ahmed, S. Nahar, M. Safavieh and M. Zourob, *Analyst*, 2013, **138**, 907-915.
8. T. Defever, M. Druet, D. Evrard, D. Marchal and B. Limoges, *Analytical Chemistry*, 2011, **83**, 1815-1821.
9. T. Defever, M. Druet, M. Rochelet-Dequaire, M. Joannes, C. Grossiord, B. Limoges and D. Marchal, *Journal of the American Chemical Society*, 2009, **131**, 11433-11441.
10. M. Goto, E. Honda, A. Ogura, A. Nomoto and K.-I. Hanaki, *Biotechniques*, 2009, **46**, 167-172.
11. D. K. Kampouris, R. O. Kadara, N. Jenkinson and C. E. Banks, *Analytical Methods*, 2009, **1**, 25-28.
12. D. C. Lee, S. P. Yip and T. M. H. Lee, *Electroanalysis*, 2013, **25**, 1310-1315.
13. Y. Mori, M. Kitao, N. Tomita and T. Notomi, *Journal of Biochemical and Biophysical Methods*, 2004, **59**, 145-157.
14. Y. Mori, K. Nagamine, N. Tomita and T. Notomi, *Biochemical and Biophysical Research Communications*, 2001, **289**, 150-154.
15. A. E. Musa, M. Asuncion Alonso-Lomillo, F. Javier del Campo, N. Abramova, O. Dominguez-Renedo, M. Julia Arcos-Martinez and J. P. Kutter, *Talanta*, 2012, **99**, 737-743.
16. N. Nagatani, K. Yamanaka, M. Saito, R. Koketsu, T. Sasaki, K. Ikuta, T. Miyahara and E. Tamiya, *Analyst*, 2011, **136**, 5143-5150.
17. C. Toumazou, L. M. Shepherd, S. C. Reed, G. I. Chen, A. Patel, D. M. Garner, C.-J. A. Wang, C.-P. Ou, K. Amin-Desai, P. Athanasiou, H. Bai, I. M. Q. Brizido, B. Caldwell, D. Coomber-Alford, P. Georgiou, K. S. Jordan, J. C. Joyce, M. La Mura, D. Morley, S. Sathyavathan, S. Temelso, R. E. Thomas and L. Zhang, *Nature Methods*, 2013, **10**, 641-646.
18. D. Ulahannan, M. B. Kovac, P. J. Mulholland, J. B. Cazier and I. Tomlinson, *British Journal of Cancer*, 2013, **109**, 827-835.
19. F. Zhang, R. Wang, L. Wang, J. Wu and Y. Ying, *Chemical communications (Cambridge, England)*, 2014, **50**, 14382-14385.
20. W. Jaroenrama, W. Kiatpathomchai and T. W. Flegel, *Molecular and Cellular Probes*, 2009, **23**, 65-70.
21. T. Nimitphak, W. Kiatpathomchai and T. W. Flegel, *Journal of Virological Methods*, 2008, **154**, 56-60.
22. T. Puthawibool, S. Senapin, W. Kiatpathomchai and T. W. Flegel, *Journal of Virological Methods*, 2009, **156**, 27-31.
23. R. Wang, J. Wu, F. Zhang, L. Wang and F. Ji, *Analytical Methods*, 2014, **6**, 9198-9201.
24. P. Chaivisuthangkura, C. Srisuk, S. Rukpratanporn, S. Longyant, P. Sridulyakul and P. Sithigorngul, *Journal of Virological Methods*, 2009, **162**, 188-193.
25. T. Nimitphak, W. Meemetta, N. Arunrut, S. Senapin and W. Kiatpathomchai, *Molecular and Cellular Probes*, 2010, **24**, 1-5.
26. T. Puthawibool, S. Senapin, T. W. Flegel and W. Kiatpathomchai, *Molecular and Cellular Probes*, 2010, **24**, 244-249.
27. S.-M. Tsai, H.-J. Liu, J.-H. Shien, L.-H. Lee, P.-C. Chang and C.-Y. Wang, *Journal of Virological Methods*, 2012, **181**, 117-124.
28. K. Roskos, A. I. Hickerson, H. W. Lu, T. M. Ferguson, D. N. Shinde, Y. Klaue and A. Niemz, *PLoS One*, 2013, **8**, 1-7.
29. X. Wang, D. Teng, Q. Guan, F. Tian and J. Wang, *Food Control*, 2013, **29**, 213-220.
30. Z. K. Njiru, *Diagnostic microbiology and infectious disease*, 2011, **69**, 205-209.
31. T. Nimitphak, W. Meemetta, N. Arunrut, S. Senapin and W. Kiatpathomchai, *Molecular and cellular probes*, 2010, **24**, 1-5.
32. N. Arunrut, P. Prombun, V. Saksmerprome, T. W. Flegel and W. Kiatpathomchai, *Journal of virological methods*, 2011, **171**, 21-25.
33. W. Ding, J. Chen, Y. Shi, X. Lu and M. Li, *Archives of virology*, 2010, **155**, 385-389.
34. N. Arunrut, Y. Seetang-Nun, J. Phromjai, W. Panphut and W. Kiatpathomchai, *Journal of virological methods*, 2011, **177**, 71-74.
35. L. Cui, Y. Ge, X. Qi, G. Xu, H. Li, K. Zhao, B. Wu, Z. Shi, X. Guo and L. Hu, *Journal of clinical microbiology*, 2012, **50**, 3881-3885.
36. F. Zhang, L. Wang, K. Fan, J. Wu and Y. Ying, *Analytical and Bioanalytical Chemistry*, 2014, **406**, 3069-3078.

1
2
3
4
5
6
7
8
9
10
11
12
13
14
15
16
17
18
19
20
21
22
23
24
25
26
27
28
29
30
31
32
33
34
35
36
37
38
39
40
41
42
43
44
45
46
47
48
49
50
51
52
53
54
55
56
57
58
59
60

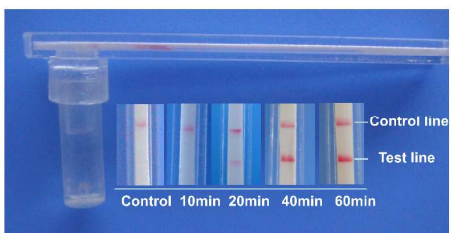
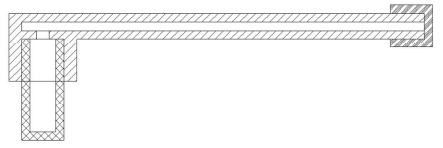

With the enclosed and portable LFD cartridge, GMO can be tested specifically without the generation of cross-contamination.