



**Recent Developments in the Synthesis and Utilization of  
Chiral  $\beta$ -Aminophosphine Derivatives as Catalysts or  
Ligands**

Journal:	<i>Chemical Society Reviews</i>
Manuscript ID	CS-SYN-06-2015-000469.R2
Article Type:	Review Article
Date Submitted by the Author:	23-Dec-2015
Complete List of Authors:	Zhang, Junliang; East China Normal University, Department of Chemistry Li, Wenbo; East China Normal University, School of Chemistry and Molecular Engineering

## ARTICLE

# Recent Developments in the Synthesis and Utilization of Chiral $\beta$ -Aminophosphine Derivatives as Catalysts or Ligands

Cite this: DOI: 10.1039/x0xx00000x

Wenbo Li,<sup>a</sup> Junliang Zhang<sup>\*a,b</sup>Received 00th January 2012,  
Accepted 00th January 2012

DOI: 10.1039/x0xx00000x

www.rsc.org/

In the last years, the research area of chiral  $\beta$ -aminophosphines capable of promoting a wide range of diverse organic transformations has attracted many attentions. Their derivatives constitute attractive reagents towards this end, due to their stability, low toxicity and ease of handling. These novel  $\beta$ -aminophosphine derivatives are potentially useful as organocatalysts and ligands in metal-catalysed reactions. In particular, chiral  $\beta$ -aminophosphines have recently emerged as powerful phosphine catalysts in asymmetric synthesis and catalysis. The asymmetric transformations to which metal complexes of these ligands have been applied include palladium-catalysed allylic substitutions and copper-catalysed 1,4-additions to enones among others. This review summarizes the most significant developments in the area of synthesis and application of chiral  $\beta$ -aminophosphine derivatives, providing a detailed overview of the current state of the art and including future aspects.

## 1. Introduction

Catalytic asymmetric transformations mediated by bio-, transition-metal, and organic catalysts have served as a powerful means to access a wide range of optically pure compounds.<sup>1</sup> These stoichiometric approaches usually rely on the successful design and synthesis of chiral catalysts and ligands. Due to the dual capacity of phosphine serves as either ligands or as catalysts in the absence of metals, it has been well established that chiral  $\beta$ -aminophosphine derivatives as ligands or catalysts play important roles in the areas of coordination chemistry and catalysis.

Because of the significance of this scaffold both from synthetic and applied points of view, tremendous progress has been achieved in this field. The continual renewal of interest in the chemistry of this framework is mainly due to its versatile reactivity, making it a very useful and efficient chiral catalyst or ligand with a valuable impact in modern asymmetric synthesis. Hence, the development of new, more efficient synthetic methodologies for preparation of chiral  $\beta$ -aminophosphine derivatives is receiving broad attention from many groups all over the world. Such compounds are typically prepared using enantiopure starting materials, chiral auxiliaries or by resolution of the racemic compound (Scheme 1). With few exceptions, most of these  $\beta$ -aminophosphines were obtained from natural amino acids, which are valuable structural motifs for efficient chiral induction in asymmetric preparations. Indeed, the design of structurally novel and

readily accessible chiral  $\beta$ -aminophosphines remains a huge challenge.

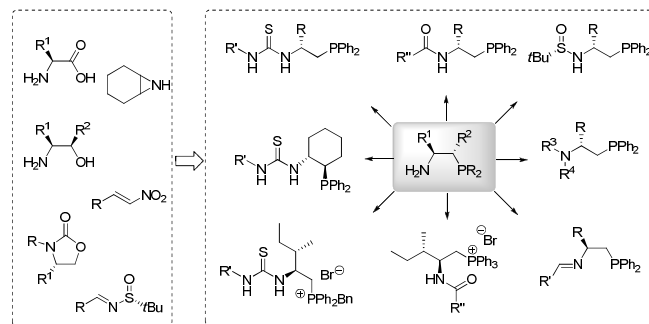

**Scheme 1** Design and Synthesis of chiral  $\beta$ -aminophosphine derivatives.

Over the past decade, nucleophilic phosphine catalysis has emerged as a powerful approach to structurally diverse and synthetically valuable building blocks in organic chemistry.<sup>2</sup> Recent development of bi- and multi-functional chiral phosphine catalysts represents an exciting advance in the nucleophilic catalysis.<sup>3</sup> The bifunctional organocatalysts provide synergic activation to nucleophile and electrophile with two activating sites, either through hydrogen bonding or Brønsted acid-Lewis/Brønsted base activation.<sup>4</sup> *N*-monosubstituted  $\beta$ -aminophosphines as a class of valuable bi- or multi-functional catalysts have been found to be highly efficient for a variety of useful asymmetric transformations.<sup>5</sup> These tertiary phosphines serve as a Lewis base in combination with chiral urea/thiourea derivatives, amides including sulfonamides and sulfinamides, as a hydrogen bonding unit. It

Shanghai Key Laboratory of Green Chemistry and Chemical Processes, Department of Chemistry, East China Normal University, 3663 N. Zhongshan Road, Shanghai 200062, China  
E-mail: [jlzhang@chem.ecnu.edu.cn](mailto:jlzhang@chem.ecnu.edu.cn)

is well-known that changing the side chain and substitution on the nitrogen atom can drastically affect catalyst performance.

Several stereoselective routes using transition-metal catalysts have been developed and provided enantiopure products. An alternative significant application of chiral  $\beta$ -aminophosphine derivatives is as  $N,P$ -ligands for transition-metal-mediated processes, generating electronic asymmetry on the metal centre through the presence of different donor atoms. The  $\pi$ -acceptor character of the phosphine can stabilise a metal centre in a low oxidation state, while the nitrogen  $\sigma$ -donor ability makes the metal more susceptible to oxidative addition reactions. Such ligands have been proven to be effective for obtaining high enantioselectivities through electronic and steric differentiations. In contrast to the  $N,P$ -ligands built on the binaphthalene and biphenyl backbones,<sup>6</sup> chiral  $\beta$ -aminophosphine derivatives were much easier to prepare and modify using established methods.

This field of research continues to grow, and the quest for new organic molecules which efficiently catalyse reactions in a highly enantioselective manner has no end in sight. Taking into consideration the enormous potential of chiral  $\beta$ -aminophosphine derivatives as catalysts and ligands, we decided to summarize the recent methods in the literature involving preparation and their utilization in asymmetric catalysis.

## 2. Synthesis of $\beta$ -aminophosphine derivatives

In designing practical chiral catalysts or ligands, the readily availability of starting chiral sources is crucial. Several natural building blocks have been widely used for the development of chiral ligand libraries. The most established protocol for the preparation of  $\beta$ -aminophosphines involves nucleophilic phosphide substitution of tosylates or mesylates derived from aminoalcohols, which are in turn derived from natural or unnatural chiral aminoacids and their derivatives. A particularly useful property of these ligands is significant oxidative stability of the phosphorus centre. For simplicity in presentation as well as understanding, this review has been classified into three major classes, based on the chiral scaffold of the catalysts or ligands: 1)  $N$ -unsubstituted aminophosphine derivatives; 2)  $N$ -monosubstituted  $\beta$ -aminophosphine derivatives; 3)  $N,N$ -disubstituted  $\beta$ -aminophosphine derivatives.

### 2.1 $N$ -unsubstituted $\beta$ -aminophosphine derivatives

Saitoh and Achiwa established the starting point for the development of  $\beta$ -aminophosphine ligand/catalyst. The phosphinobutanamine was easily accessible in four steps from  $L$ -valinol prepared by the reduction of a commercially available  $\alpha$ -amino acid,  $L$ -valine (Scheme 2).<sup>7</sup>  $L$ -valinol was converted into  $N$ -Boc-valinol by protection of the amino group with *tert*-butyl dicarbonate. Subsequent esterification with *p*-toluenesulfonyl chloride in pyridine gave tosylate **3**. The phosphinylation of **3** with potassium diphenylphosphide was conducted in THF at  $-35$  °C, giving  $N$ -Boc aminophosphine **4** which was converted into (2*S*)-2-amino-1-diphenylphosphinyl-3-methylbutane **5a** by the deprotection of the amino moiety using trifluoroacetic acid. Since then, chiral amino acids bearing different side chains had served as a rich source for catalyst design to accommodate a broad range of substrates.

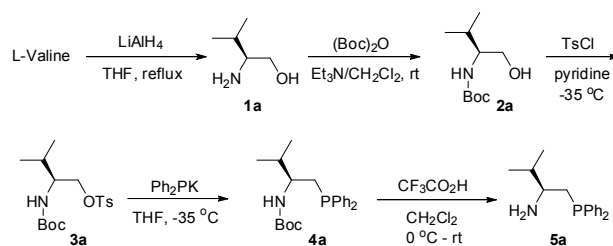

**Scheme 2** Preparation of  $N$ -unsubstituted  $\beta$ -aminophosphines from chiral aminoalcohols via nucleophilic phosphide substitution.

Guo and Abdur-Rashid reported an efficient alternative route for the synthesis of  $N$ -unsubstituted  $\beta$ -aminophosphines with multiple chiral centres by nucleophilic ring-opening of  $N$ -protected cyclic sulfamidates **9** with metal phosphides, followed by hydrolysis and deprotection (Scheme 3).<sup>8</sup> This method broadens the scope of the use of chiral aminoalcohols as precursors for the synthesis of aminophosphines. It should be mentioned that aminophosphine backbones **15a-15c** with another chiral centre have been successfully prepared in good overall yields through the ring-opening of cyclic  $N$ -protected sulfamidates **8** with the chiral phosphide **12** derived from the reaction of butyllithium and the respective phosphepine-borane, followed by hydrolysis and  $N$ -deprotection (Scheme 4).



Wenbo Li was born in Heilongjiang Province, China. She received her B.S. degree in Chemistry from East China of Normal University in 2008. Then she obtained her PhD at East China of Normal University under the supervision of Professor Junliang Zhang in 2013. Her current research includes the discovery of a hydrohalogenation reaction of

deficient conjugated enynes and the development of new enantioselective organocatalysed reactions.



Prof. Junliang Zhang obtained his PhD from the Chinese Academy of Sciences in 2002 under the supervision of Prof. Shengming Ma. Then he worked as a postdoctoral fellow successively in University of Cologne (Humboldt Fellowship) and then University of Chicago. In 2006, he joined East China Normal University as a full professor. His research interests include developing novel synthetic methodology, asymmetric catalysis. He has published more than 90 papers in international journals and three book chapters.

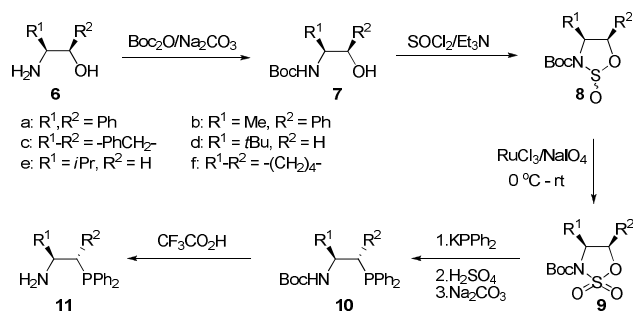

**Scheme 3** Preparation of  $\beta$ -aminophosphines from chiral aminoalcohols via cyclic sulfamidates.

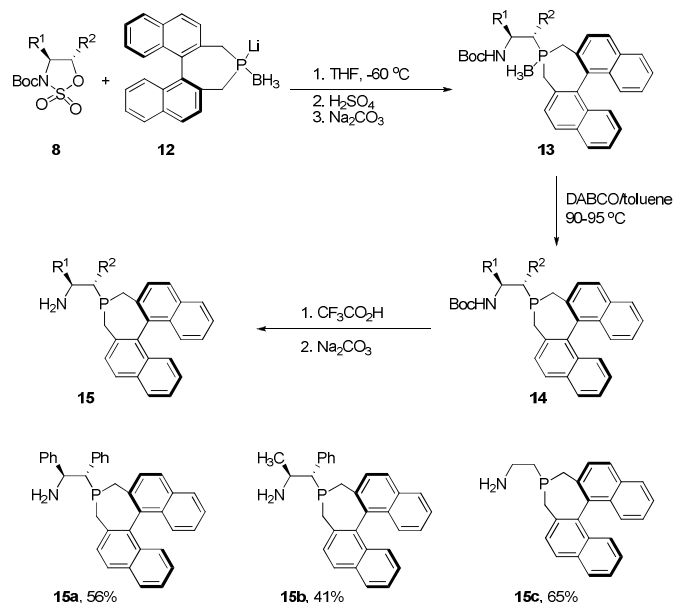

**Scheme 4** Preparation of  $\beta$ -aminophosphines **15** with multiple chiral centres.

Lu et al. first used *N*-Boc 2,2-dimethyl oxazolidine **18** as a convenient masked modified amino acid to prepare L-threonine-derived  $\beta$ -aminophosphines **20** (Scheme 5).<sup>9</sup> The syntheses of precursor **18** began from commercially available L-threonine **16** over four steps.<sup>10</sup> L-threonine **16** was protected to provide *N*-Boc amino acid methyl ester **17**, which was then converted into the corresponding alcohol **18** through protection as oxazolidine and followed by reduction with  $\text{LiAlH}_4$ .

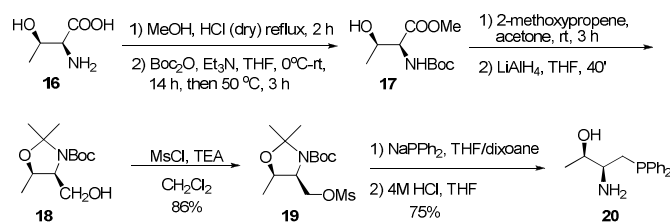

**Scheme 5** Preparation of L-threonine-derived  $\beta$ -aminophosphines **20**.

Yudin described the synthesis of a new class of cyclohexane-based P,N-ligands **23** by reaction of 7-azabicyclo[4.1.0]heptane with suitable phosphorus nucleophiles under acidic conditions (Scheme 6).<sup>11</sup> *Trans*-1-Amino-2-diphenylphosphino-cyclohexane **22** was resolved with D-tartaric acid via the

formation of the tartrate salt, which was filtered and recrystallized from water. The enantiomerically pure *N,P*-ligand **23** was then recovered by dissolving the tartrate salt in 10% sodium hydroxide solution and extracting the mixture with  $\text{CH}_2\text{Cl}_2$ .

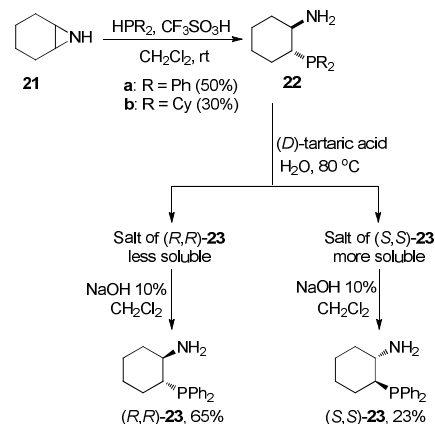

**Scheme 6** Preparation of  $\beta$ -aminophosphines **23** by resolution of racemic ligands.

An alternative route via an organocatalytic Michael addition as key step was also developed. Tan reported a catalytic asymmetric phospho-Michael reaction between diaryl phosphine oxide and nitroalkenes to synthesize chiral  $\alpha$ -substituted  $\beta$ -phosphine oxides **26**, which can be further reduced to  $\beta$ -aminophosphines **28** selectively (Scheme 7).<sup>12</sup> This catalytic method for the synthesis of optically active  $\beta$ -aminophosphines has shown to be an alternative for modulating the structures of bifunctional phosphines.

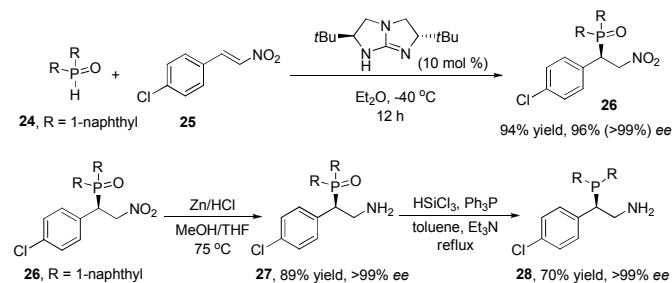

**Scheme 7** Synthesis of chiral  $\beta$ -aminophosphines **28** via a phospho-Michael reaction.

## 2.2 *N*-monosubstituted $\beta$ -aminophosphine derivatives

*N*-Monosubstituted phosphine derivatives have a wider applied range than chiral protic aminophosphines, which have been utilized as bifunctional organocatalysts or as *N,P*-ligands for asymmetric synthesis. Such compounds are typically prepared using enantiopure starting materials, such as amino acids or amino alcohols (route A, Scheme 8). The direct functionalization of *N*-unsubstituted aminophosphines with isothiocyanates or acyl chloride is clearly powerful process, providing a step and atom economical route to secondary *N,P*-ligands/catalysts with different hydrogen bond donors (route B, Scheme 8). Alkylation is an efficient route to modify aminophosphines and access their alkyl derivatives. In addition, treatment of 2-oxazolidinones and secondary phosphines using

an acid-promoted decarboxylative C-P bond formation reaction furnished a variety of *N*-monosubstituted  $\beta$ -aminophosphines (route C, Scheme 8). Asymmetric inductions by pre-existing stereogenic centres (chiral sulfinamide) also provide a reliable method for the facile construction of *N*-monosubstituted  $\beta$ -aminophosphines (route D, Scheme 8). The addition of  $R_2PCH_2Li$  to chiral sulfinimines constitutes one of the most important relevant methods for C-C<sub>P</sub> bond formation, and chiral sulfinimines could be easily prepared from commercially available *tert*-butylsulfonamide and aldehyde.

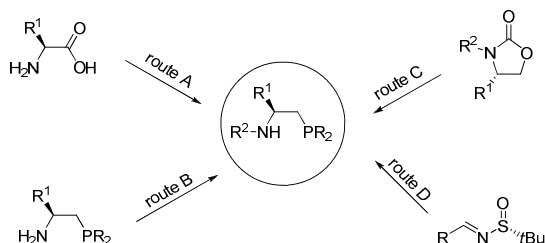

**Scheme 8** General methods for preparation of chiral *N*-monosubstituted  $\beta$ -aminophosphines.

A set of phosphine sulfonamide ligands **30a-e** can be prepared in two steps from amino alcohols (Scheme 9). Treatment of either valinol or *tert*-leucinol with *p*-toluenesulfonyl chloride (TsCl), methane-sulfonyl chloride (MsCl), or trifluoromethanesulfonyl anhydride (Tf<sub>2</sub>O) produced sulfonyl aziridines **29a-e**. Then treatment of aziridines with LiPPh<sub>2</sub> produced the ligands in good overall yield for the straightforward two-step sequence.<sup>13</sup>

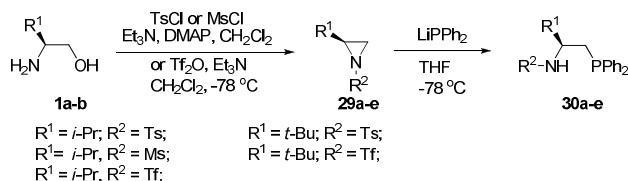

**Scheme 9** Preparation of sulfonamide phosphine **30a-e**.

Considering the sensitive nature of the phosphination, Hilmersson developed an alternative robust and scalable route to chiral 1-isopropylamino-2-(diphenylphosphino)ethanes **35a-c** via the nucleophilic ring opening of chiral cyclic sulfamidates **34** (Scheme 10).<sup>14</sup> The key to the success of the phosphination is the use of the cyclic sulfamidate, avoiding aziridine formation, as well as a rapid, clean and *in-situ* hydrolysis of the sulfamic acid intermediate in the presence of wet acidic silica gel.

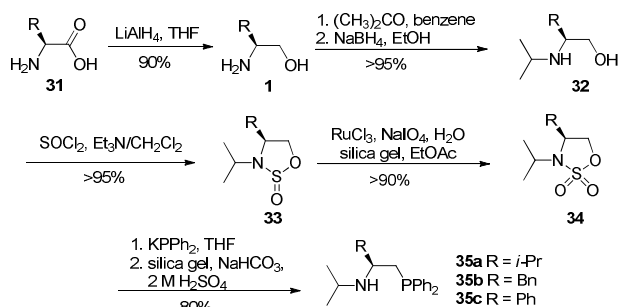

**Scheme 10** Preparation of *N*-alkyl aminophosphines **35a-c** via the ring-opening of sulfamidates with KPPh<sub>2</sub>.

It is noteworthy that bifunctional chiral  $\beta$ -aminophosphine derivatives have been widely used in organic chemistry, and the synergistic interactions of two functionalities have been proven to be extremely powerful in asymmetric catalysis. In 2008, Jacobsen designed a series of bifunctional phosphine-thiourea catalysts derived from readily accessible *trans*-2-amino-1-(diphenylphosphino)cyclohexane and applied them to the enantioselective imine-allene annulations.<sup>15</sup> The synthesis of this class of  $\beta$ -aminophosphine derivatives **91** begins with commercially available *N*-Boc-protected alanine **36**, which was coupled to dibenzylamine and followed by *N*-deprotection (Scheme 11). The primary amine **39** was treated with CSCl<sub>2</sub> in the presence of DCC to give the desired isothiocyanate **40** without further purification. Then, the reaction of isothiocyanate intermediate **40** and (*1R,2R*)-2-(diphenylphosphino)-cyclohexanamine **23** provided the desired phosphinothiourea derivative **41** with a tunable additional amino acid residue.

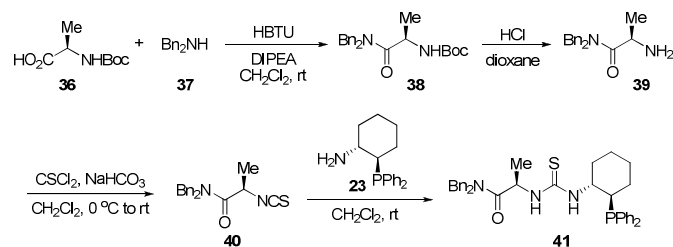

**Scheme 11** Preparation of phosphinothiourea derivative **41**.

In order to develop efficient catalysts for a series of asymmetric [3+2] annulation reactions, Shi group<sup>16</sup> designed and synthesized a series of multifunctional thiourea-phosphine catalyst (**TP**) derived from natural amino acids. Thiourea-based organocatalysts have caught significant attention due to their ability to activate substrates through hydrogen-bonding. Usually, **TPs-43** have been readily synthesized in one step from compound **5** and isothiocyanate in 77~>99% yield (method A, Scheme 12). As it is well known, the steric and electronic nature of the thiourea group can be easily tuned by reacting the corresponding amine with different isothiocyanates. Another approach involved the treatment of the compound **5** with CS<sub>2</sub> in the presence of DCC to give the desired isothiocyanate **42**, following by its reaction with amines (method B, Scheme 12).

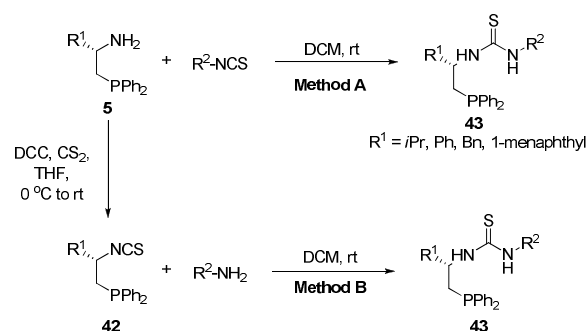

**Scheme 12** Preparation of multi-functional thiourea-phosphines **43**.

Advancements in acylation procedures between chiral  $\beta$ -aminophosphines **5/20** and carboxylic acid or acyl chloride offer new routes to functionalized *N*-acyl  $\beta$ -aminophosphine derivatives **44** (Scheme 13).<sup>17</sup> The corresponding structures of

these catalysts **44** mentioned in this review are shown in Scheme 14.

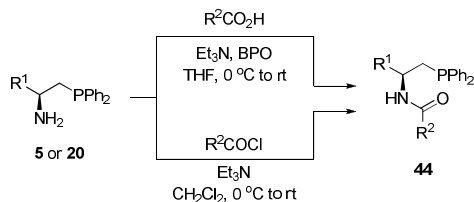

**Scheme 13** Typical preparation of *N*-acyl  $\beta$ -aminophosphine derivatives **44**.

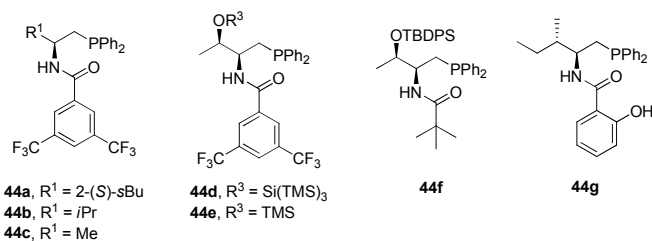

**Scheme 14** *N*-acyl  $\beta$ -aminophosphine derivatives **44** as organocatalysts used in the reactions described in this review.

Using phosphinobutanamine as a key substrate, Saitoh group synthesized a series of chiral diphosphine ligand **45a–c** with *C*<sub>2</sub>-symmetry elements.<sup>7a</sup> Treatment of phosphinobutanamine and phthaloyl chloride in the presence of diisopropylethylamine in toluene at reflux was carried out to prepare the preferable production of **45a** in 53% yield (Scheme 15). The system also gave the ligands **45b** and **45c** with different backbones to connect the two amide groups in 77% and 44%, respectively (Scheme 15). Börner achieved the analogous ligand **45d** by two synthetic routes in common with the use of HO-protected tartaric acid dichlorides (Scheme 16).<sup>18</sup>

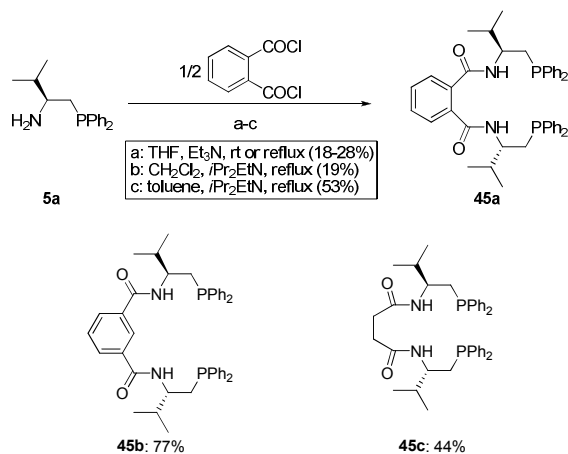

**Scheme 15** Preparation of multi-dentate aminophosphines **45**.

A recent report by Lu et al. described an approach to versatile dipeptide-based chiral  $\beta$ -aminophosphine derivatives, which were easily accessed in several steps from two amino acids.<sup>9</sup> For example; D-Thr-L-*tert*-Leu-derived  $\beta$ -aminophosphine **47a** was synthesized by choosing threonine as the first amino acid residue and engaging *tert*-leucine as the second amino acid residue (Scheme 17). The readily accessible D-Thr-L-*tert*-Leu-derived **47a** provided *O*-TBDPS-D-Thr-L-*tert*-Leu-

derived **48a** by varying the siloxy groups on the OH of threonine. Such dipeptide-based  $\beta$ -aminophosphine derivatives are highly reactive, and their structures are easily tunable.

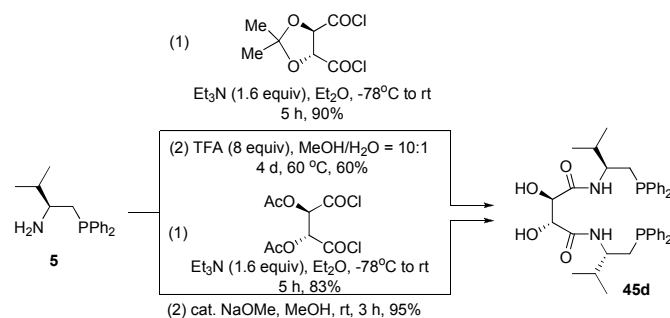

**Scheme 16** Preparation of tartaric amide bisphosphine **45d**.

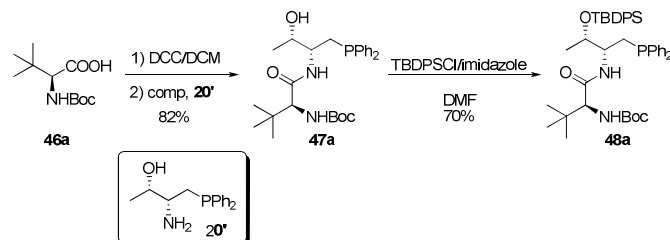

**Scheme 17** Preparation of dipeptide-based  $\beta$ -aminophosphine derivative **48a**.

A variety of 2-(tertiary phosphino)-1-amines **50** have been prepared from 2-oxazolidinones **49** and secondary phosphines using an acid-promoted decarboxylative C–P bond formation reaction (Scheme 18).<sup>19</sup> The initial molar ratio of **49**, HP(C<sub>6</sub>H<sub>5</sub>)<sub>2</sub> and TfOH is set to 1:2:3. A 3-fold excess of TfOH is required to fully protonate **49** to generate **49**•TfOH, since HP(C<sub>6</sub>H<sub>5</sub>)<sub>2</sub> possibly serves as a competing proton acceptor. And also, a 2-fold excess of HP(C<sub>6</sub>H<sub>5</sub>)<sub>2</sub> is necessary to maintain a sufficient concentration of the nonprotonated molecules, which undergo nucleophilic attack at 5-position of **49**•TfOH. This procedure also offers a complementary approach to generate *N*-unsubstituted  $\beta$ -aminophosphines **5**, when the substituent R<sup>1</sup> was hydrogen. Unfortunately, this method cannot be applied in the reaction of dialkylphosphines.

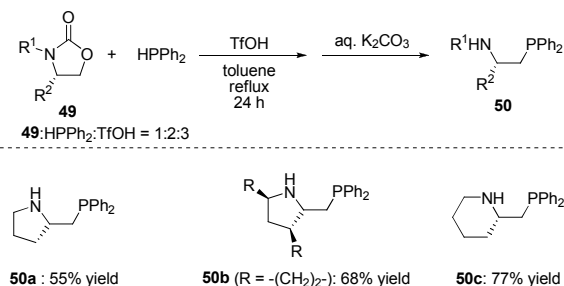

**Scheme 18** Preparation of 2-(Diarylphosphino)-1-amines **50** from 2-Oxazolidinones.

Methods that do not rely on natural amino acids as basic chiral backbone have become increasingly important. Very recently, we have developed a concise approach to a series of multifunctional sulfinamide phosphines **52**, which could be easily prepared from commercially available Ph<sub>2</sub>PCH<sub>3</sub>, *tert*-butylsulfinamide and aldehyde (Scheme 19).<sup>20</sup> Treatment of

$\text{Ph}_2\text{PCH}_3$  with BuLi in the presence of TMEDA at room temperature produced a solution of  $\text{Ph}_2\text{PCH}_2\text{Li}$  in THF. Then  $\text{Ph}_2\text{PCH}_2\text{Li}$  undergoes nucleophilic addition to chiral (*RS*)-sulfinimines, thereby furnishing the corresponding sulfinamide-phosphines **52** (named Xiao-Phos) in good yield with moderate to high diastereoselectivity. It is noteworthy that the method showed great potential utility in synthesis of *N*-unsubstituted  $\beta$ -aminophosphines **5** and various *N*-monosubstituted  $\beta$ -aminophosphine derivatives **43/44**.

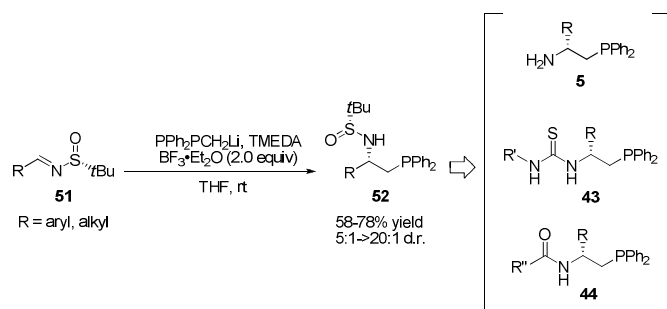

Oshima et al. reported a radical phosphination reaction to provide *trans*-aminophosphine derivative **54** (Scheme 20).<sup>21</sup> Tetraphenylbiphosphine would approach the radical, generated by decomposition of carbothioate, from the opposite side of the amino group.

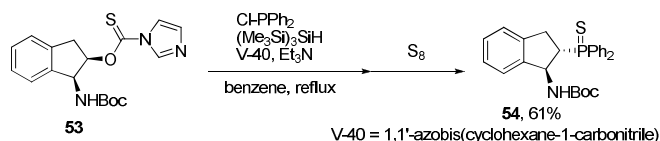

Phosphine-containing amino acid is a special class of  $\beta$ -aminophosphine derivatives, which can be placed into short peptide sequences possessing stable secondary structures. The original approach to the desired amino acids was through Evans chiral oxazolidone strategy (Scheme 21).<sup>22</sup> This method has proved to be very versatile, allowing for the synthesis of a number of different phosphine-containing amino acids via diastereo-selective reactions, which are critically dependent upon reaction conditions and work-up procedures. Phosphine sulfides are excellent surrogates for the phosphine group can be converted to the phosphine by reaction with Raney nickel<sup>22</sup> or methylation followed by transfer of the methylated sulfur to HMPT.<sup>23</sup>

The same compound **59** can be synthesized through a second route, which has been successfully used to synthesize a number of phosphine-containing amino acids (Scheme 22).<sup>24</sup> Primary and secondary iodo amino acids were converted to zinc iodides. The resulting organozinc iodides were reacted with copper, and then coupled with aryl or alkyl phosphine chlorides. The phosphine was then protected as the phosphine sulphide **62**. Ester hydrolysis and exchange of Boc for Fmoc protection provided the desired amino acid **59** in high yield. Stelzer also achieved the phosphino derivatives of serine **63** by nucleophilic phosphination of *N*-(*tert*-butoxycarbonyl)-3-iodo-*L*-alanine methylester **60** with secondary phosphines  $\text{R}_2\text{PH}$  in DMF using potassium carbonate as the base (Scheme 23).<sup>25</sup>

The same compound **59** can be synthesized through a second route, which has been successfully used to synthesize a number of phosphine-containing amino acids (Scheme 22).<sup>24</sup> Primary and secondary iodo amino acids were converted to zinc iodides. The resulting organozinc iodides were reacted with copper, and then coupled with aryl or alkyl phosphine chlorides. The phosphine was then protected as the phosphine sulphide **62**. Ester hydrolysis and exchange of Boc for Fmoc protection provided the desired amino acid **59** in high yield. Stelzer also achieved the phosphino derivatives of serine **63** by nucleophilic phosphination of *N*-(*tert*-butoxycarbonyl)-3-iodo-*L*-alanine methylester **60** with secondary phosphines  $\text{R}_2\text{PH}$  in DMF using potassium carbonate as the base (Scheme 23).<sup>25</sup>

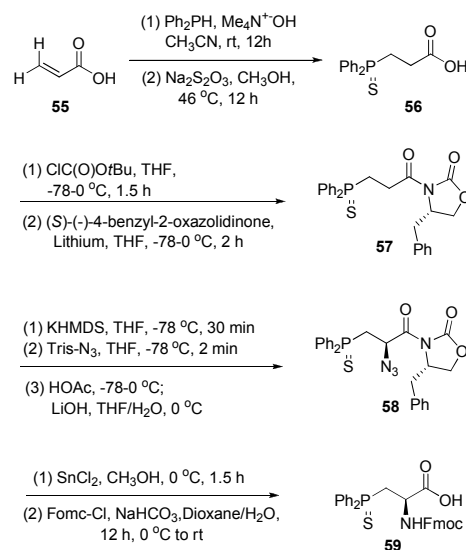

**Scheme 22** Preparation of phosphine-containing amino acid **59** via an organozinc iodide intermediate.

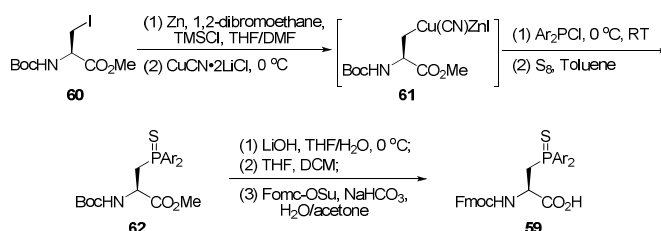

**Scheme 23** Preparation of phosphine-containing amino acid **63** via a substitution reaction.

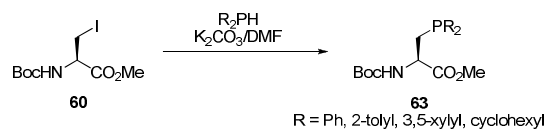

**Scheme 24** Preparation of phosphine sulphide-containing amino acid **68** from serine.

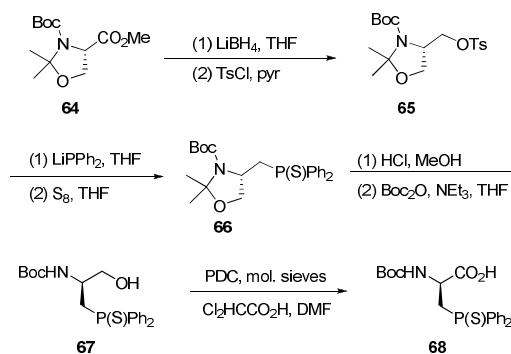

An alternative procedure to the phosphine sulfide from serine involved reduction of the ester and tosylation, a nucleophilic displacement using phosphide, cleaving the oxazolidine, and oxidation of alcohol (Scheme 24).<sup>26</sup> This method can give optically pure product via a protocol amenable to scale-up.

A proline derived phosphine **74** was synthesized through substitution of *trans*-hydroxyproline **69** by a phosphorus nucleophile. The original method required conversion of the acid to a protected alcohol and then nucleophilic substitution followed by reoxidation of the phosphine sulfide alcohol.<sup>27</sup> Then, Gilbertson discovered that the oxazoline group is an excellent group for the protection of the acid moiety during the nucleophilic addition (Scheme 25).<sup>28</sup> Depending on the care taken with the phosphide addition, some epimerization of the proline  $\alpha$ -carbon can take place. However, the two diastereomers were easily separated by chromatography.

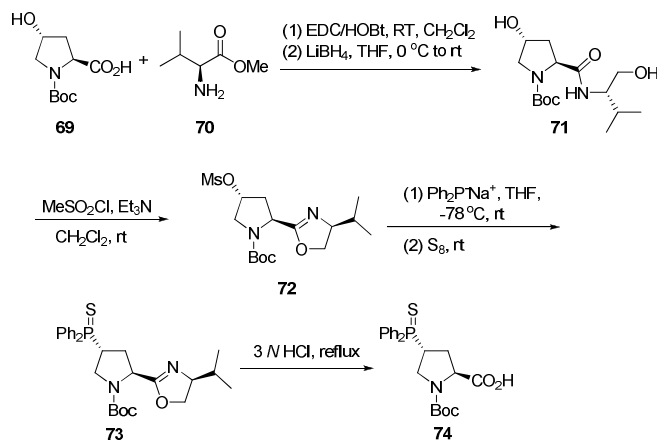

**Scheme 25** Preparation of proline derived phosphine **74**.

### 2.3 *N,N*-disubstituted $\beta$ -aminophosphine derivatives

The conformationally flexible tertiary amide group placed between the source of chirality and phosphine atom has been shown to effectively convey the chiral information, especially in the metal catalysed asymmetric reactions.

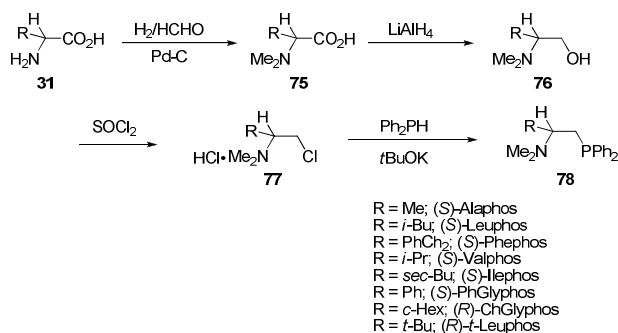

**Scheme 26** Preparation of a series of *N,N*-dimethyl  $\beta$ -dimethylaminophosphines **78**.

In order to minimize problems associated with oxidation, Kumada and co-workers introduced the phosphine group in late stage (Scheme 26).<sup>29</sup> In this strategy, generating the hydrochloride salt of *N,N*-dimethyl amino alcohol **77** before conversion of the hydroxyl function to a chloride leaving group for displacement with potassium diphenylphosphine successfully avoided the formation of aziridinium ions. A similar sequence of reactions starting with (*S*)-proline gave the chiral phosphine with the pyrrolidine five membered ring.

As the Kumada type synthesis of ligands **79** and **84** were unsuccessful, the *N*-iso-propyl group was introduced by reductive alkylation of the (*S*)-valine methyl ester and followed

by selective formylation to give *N*-iso-propyl-*N*-methyl aminophosphine **79** (Scheme 27).<sup>30a</sup> Anderson achieved *N*-phenyl-*N*-methyl aminophosphine **84** using an *N*-formyl group as a latent methyl group, subsequent introduction of the diphenylphosphine group and reduction to the *N*-methyl derivative with borane-dimethylsulfide (BMS) complex (Scheme 28).<sup>30b</sup> Malkov reported a similar method for synthesis of *N*-alkyl-*N*-acyl aminophosphines **90** from *N*-formyl alcohol **85** via acylation (Scheme 29).<sup>31</sup>

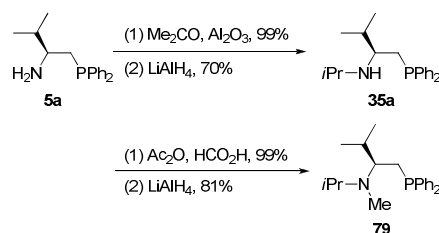

**Scheme 27** Preparation of *N*-phenyl-*N*-methyl  $\beta$ -amino phosphines **79**.

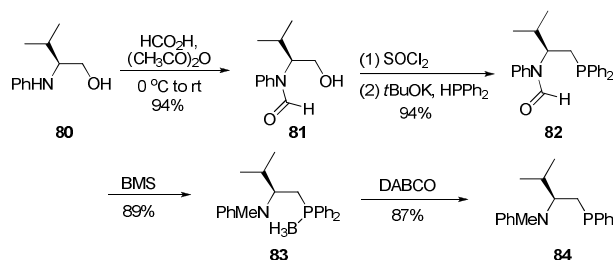

**Scheme 28** Preparation of *N*-phenyl-*N*-methyl  $\beta$ -amino phosphines **84**.

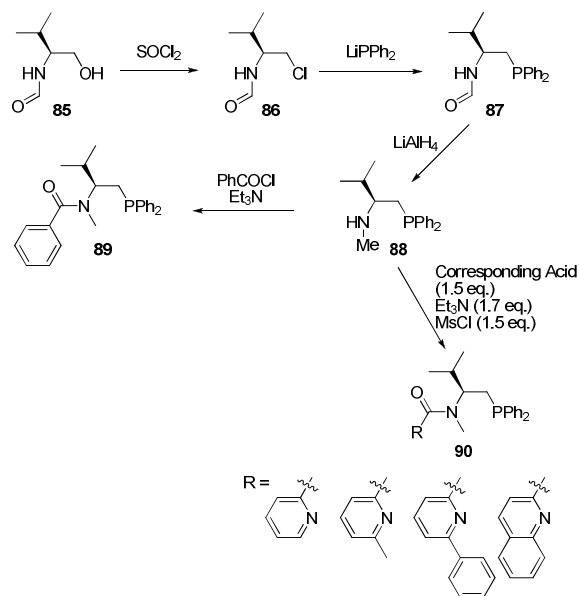

**Scheme 29** Preparation of *N*-alkyl-*N*-acyl  $\beta$ -aminophosphines **90**.

### 3. Asymmetric Organocatalytic Reactions

The development of nucleophilic phosphine organocatalysis has made remarkable progress in recent years, and phosphine-mediated reactions have emerged as a powerful tool for the



rapid generation of enantiomerically enriched compounds with complex molecular structures. In a general mode of activation, a tertiary phosphine adds to activated alkenes, allenes, or alkynes to form a zwitterion, which then gets trapped by a suitable electrophile. In the following, the most salient specific examples appeared in the literatures, mostly in the last ten years timeframe, are described.

### 3.1 Cycloadditions of allenates to activated olefins, imines and pyrazolones

For the construction of five-membered ring systems, phosphine-mediated [3+2] annulation represents one of the most efficient strategies. In recent years, a regioselective and stereoselective approach to cyclopentene formation using a chiral phosphine-catalysed [3+2] cycloaddition between electron-deficient olefins, imines and allenates has been developed. Miller and co-workers pioneered the use of multifunctional  $\alpha$ -amino acid derived phosphines **63** as efficient catalysts for allenate-enone cycloadditions (Scheme 30)<sup>32</sup>. Notably, it was found that in whether or not racemic allene substrates could be subjected to “dynamic kinetic asymmetric transformations” with a set of chalcones.

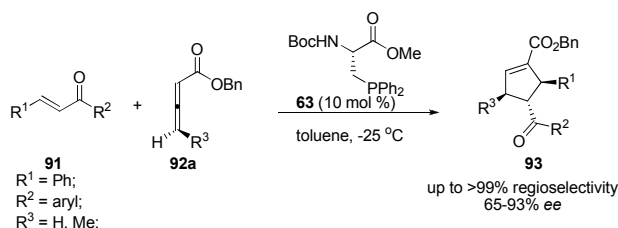

**Scheme 30** Asymmetric [3+2] cycloadditions of allenates and olefins catalysed by bifunctional *N*-acyl aminophosphines.

Later, Zhao and co-workers applied a novel bifunctional *N*-acyl amino-phosphine catalyst **44a** for the catalytic asymmetric [3+2] cycloaddition of allenates **92b** and dual activated olefins **94**, providing the corresponding cyclopentenes **95** in excellent yields and enantioselectivities (Scheme 31).<sup>17</sup> In addition to the high *ee* values achieved, this system also provided regioselectivity opposite to those obtained with monodentate phosphine catalysts in similar reactions.

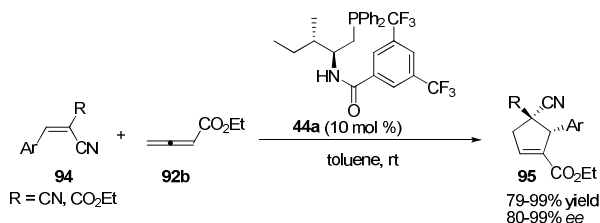

**Scheme 31** Asymmetric [3+2] cycloadditions of allenates and dual activated olefins catalysed by bifunctional *N*-acyl aminophosphines.

Lu et al. utilized dipeptide-based chiral phosphine **48b** as a catalyst for the synthesis of functionalized cyclopentenes **97** with quaternary stereogenic centres in high yields and with excellent enantioselectivities (Scheme 32(a)).<sup>9</sup> This is the first time to employ  $\alpha$ -substituted acrylates in the enantioselective cycloaddition reactions. Besides  $\alpha$ -aryl substituted acrylates,  $\alpha$ -alkyl substituted acrylates resulted in the formation of the desired product in high yield, but only with moderate

enantioselectivity. D-Threonine-*L*-tert-leucine derived bifunctional phosphine **48b** were further applied to the asymmetric [3+2] cycloadditions of allenates with acrylamides **98** and maleimides **100**, affording a series of functionalized cyclopentenes **99**, **101** in high yields and with moderate to excellent enantioselectivities (Scheme 32(b),32(c)).<sup>33</sup>

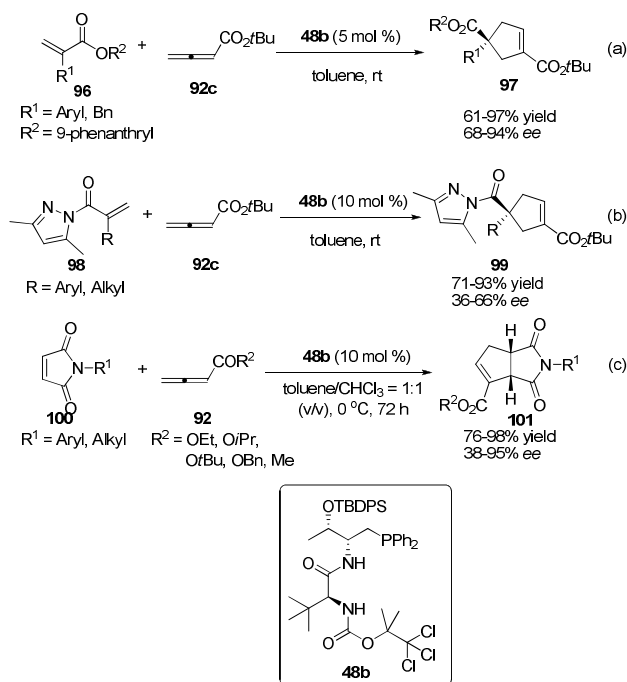

**Scheme 32** Enantioselective [3+2] cycloadditions of allenates and less activated olefins catalysed by dipeptide-derived aminophosphines **48b**.

Importantly, the functionalized cyclopentenes represent a family of valuable building blocks for construction of biologically potential chiral heterocycles. For example, further elaboration of the cycloaddition product **97** would afford a spiral oxindole **102**, an agent displaying interesting cytotoxic activities (Scheme 33). According to Ung's procedure, reduction of the nitro group in **97** resulted in a spontaneous lactam formation and yielded spiral oxindole core **102**, which was transferred to **103** through hydrolysis and coupling.<sup>34</sup>

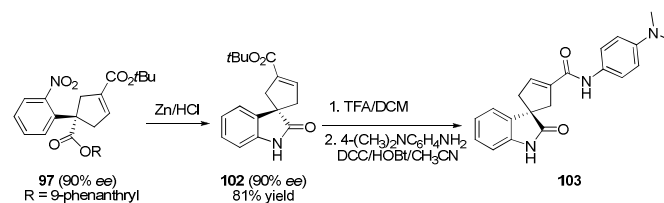

**Scheme 33** Preparation of a spiral oxindole derivative **103** from cycloaddition product **97**.

Jacobsen and co-workers demonstrated bifunctional phosphine-containing thioureas **41** catalysed allenolate-imine cycloadditions with excellent enantioselectivities (Scheme 34).<sup>15</sup> The beneficial effect of  $\text{Et}_3\text{N}$  and  $\text{H}_2\text{O}$  on the rate of the cycloaddition reaction is accompanied by negligible effects on enantioselectivity. Recently in 2012, Lu and co-workers developed a similar enantioselective imine-allene [3+2] cycloaddition with the dipeptide phosphine catalyst **48a**

(Scheme 35).<sup>35</sup> It should be noted that alkyl imines could be utilized in this reaction for the first time and the method could be used as a key step in the concise formal synthesis of (+)-trachelanthamidine (Scheme 36).

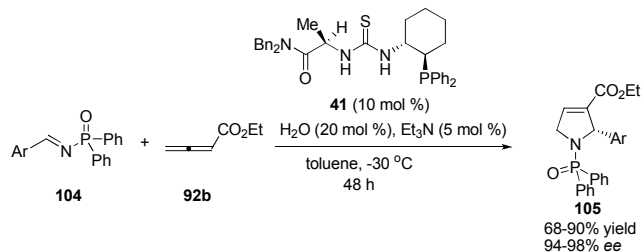

**Scheme 34** Asymmetric [3+2] cycloadditions of allenates and imines catalysed by thiourea-phosphines **41**.

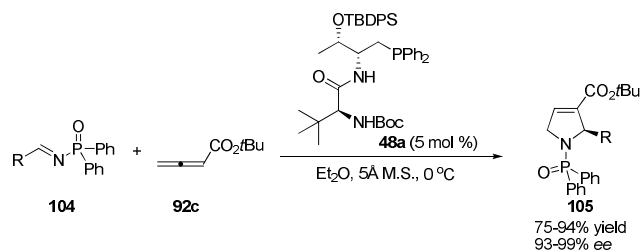

**Scheme 35** Asymmetric [3+2] cycloadditions of allenates and imines catalysed by dipeptide phosphines **82b**.

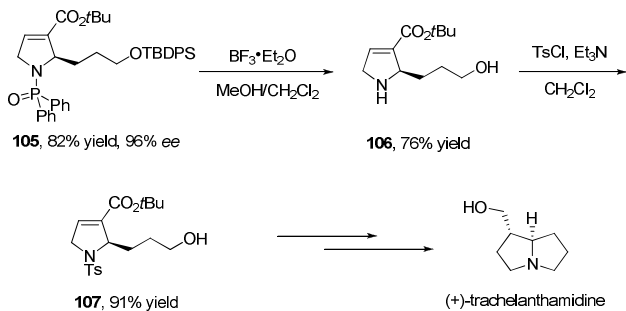

**Scheme 36** A formal synthesis of (+)-trachelanthamidine.

The scope of this type of reaction has been broadened by the group of Guo *et al.* by using bifunctional chiral phosphine **44a** as catalyst.<sup>36</sup> The [3+2] cycloaddition reaction of sulfamate-derived cyclic imines **108** with allenate **92a** afforded sulfamate-fused dihydropyrroles **109** in good yields with moderate to excellent enantiomeric excesses (Scheme 37).

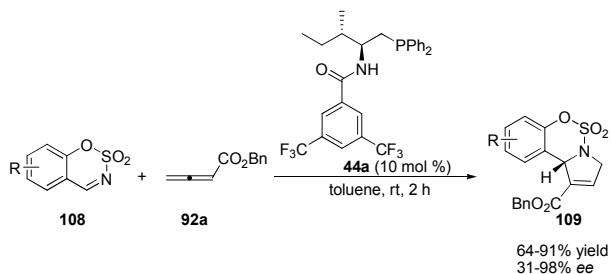

**Scheme 37** Asymmetric [3+2] cycloadditions of allenates and cyclic imines **108**.

Besides [3+2] cycloaddition reactions of allenates, asymmetric [4+2] cycloadditions by a chiral bifunctional  $\beta$ -aminophosphine were also developed. In 2011, Zhao *et al.* described a highly diastereoselective and enantioselective [4+2] cycloaddition between  $\alpha$ -substituted allenates **111** and tosylaldimines **110** catalysed by bifunctional *N*-acyl aminophosphines **44a**, which provided a facile access to optically active tetrahydropyridines **112** (Scheme 38).<sup>37</sup> Later, Lu *et al.* also disclosed highly enantioselective [4+2] cycloaddition of activated alkenes **94** with  $\alpha$ -substituted allenates **113** catalysed by amino acid-based bifunctional phosphines **44d** (Scheme 39).<sup>38</sup> In particular, 3-spirocyclohexene-2-oxindoles **116** were prepared in high yields and with excellent enantioselectivities (Scheme 40).

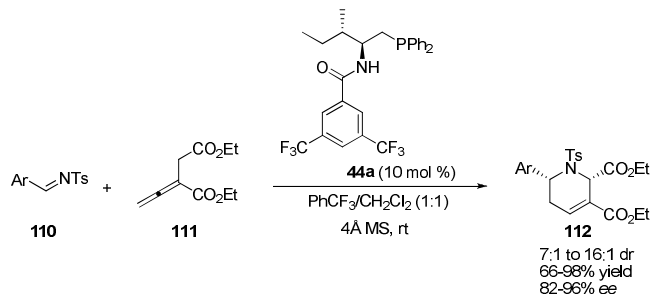

**Scheme 38** Asymmetric [4+2] cycloadditions of allenates and tosylaldimines **110** catalysed by *N*-acyl aminophosphines **44a**.

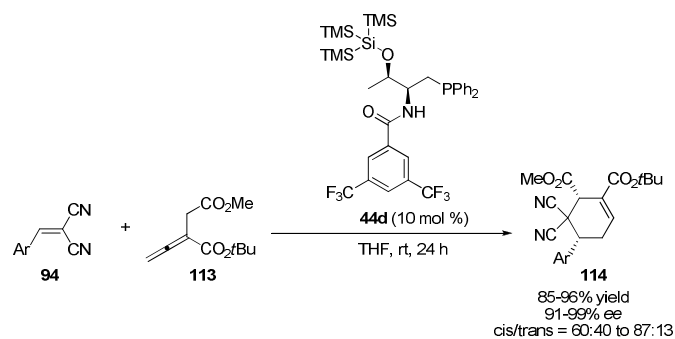

**Scheme 39** Asymmetric [4+2] cycloadditions of allenates and alkenes **94** catalysed by *N*-acyl aminophosphines **44d**.

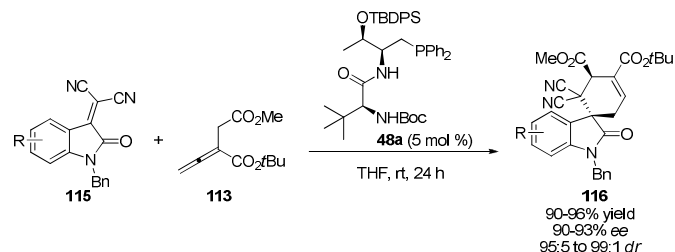

**Scheme 40** Asymmetric [4+2] cycloadditions of allenates and alkenes **115** catalysed by *N*-acyl aminophosphines **48a**.

Very recently, the same group reported the utilization of  $\alpha$ -substituted allene ketones **118** in phosphine-catalysed [4+2] annulation reactions with  $\beta,\gamma$ -unsaturated  $\alpha$ -keto esters **117** to construct dihydropyran architectures, and allene ketone was used as  $\text{C}_2$  synthon in these studies (Scheme 41).<sup>39</sup> Surprisingly, bifunctional aminophosphines containing an amide terminal **48c** preferentially gave the (*S*)-enantiomer **119** ( $\geq 99\%$  ee in most cases). In fact, the presence of  $\alpha\text{-R}^4$  group in allene ketones suppressed [3+2] cycloaddition by preventing enolate

C-attack at the carbonyl  $\alpha$ -position. However,  $\alpha$ -methyl allenoate failed to react with keto ester. Furthermore, the optically enriched [3+2] cycloaddition product **119** can be readily derived into chiral dihydropyranones, anti-hypercholesterolemic agent **123** (Scheme 42).

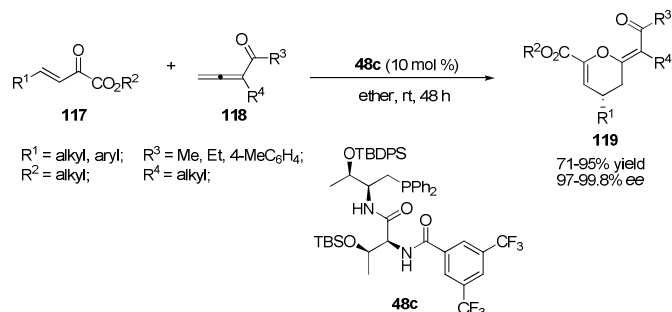

**Scheme 41** Asymmetric [4+2] cycloadditions of allene ketones and highly activated alkenes **117** catalysed by *N*-acyl aminophosphines **48c**.

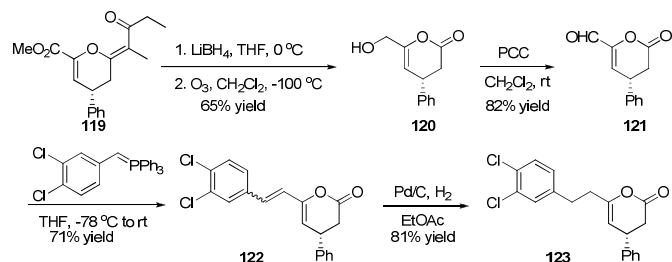

**Scheme 42** Synthesis of *anti*-hypercholesterolemic agent **123**.

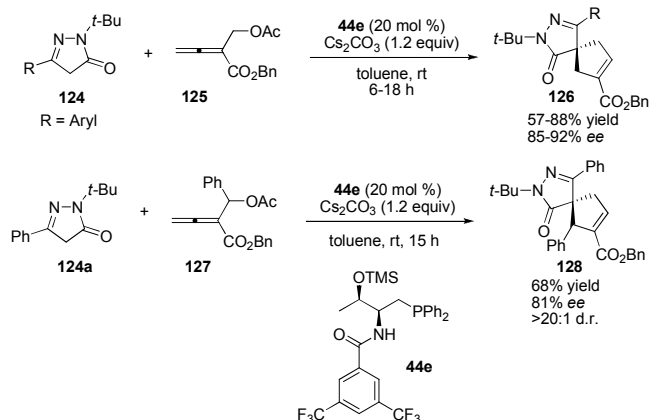

**Scheme 43** Asymmetric [4+1] cycloadditions of allenoates and pyrazolones catalysed by L-threonine-derived *O*-silylated phosphine **44e**.

For developing new types of asymmetric [m+n] annulations, Lu et al. achieved the highly enantioselective [4+1] annulation between allenoate-derived MBH acetates **124** and pyrazolones **124** catalysed by L-threonine-derived *O*-silylated phosphine **44e** (Scheme 43, up).<sup>40</sup> The scope of the reaction was extended to a variety of pyrazolones with aryl rings and heteroaromatic rings substituents, which did not vary significantly with their electronic properties. Most notably,  $\alpha$ -substituted allenoate **127** was successfully applied to [4+1] annulation for the first time to provide optically enriched 4-spiro-5-pyrazolones **128** (Scheme 43, down). The organocatalytic asymmetric [4+1] annulation of

pyrazolones and allenoate-derived MBH acetates has been applied to the concise synthesis of a structural analogue of spiro-pyrazolone, which provided an entry to chiral inhibitors of type-4 phosphodiesterase (Scheme 44). This result further highlights the practical utility of this method.

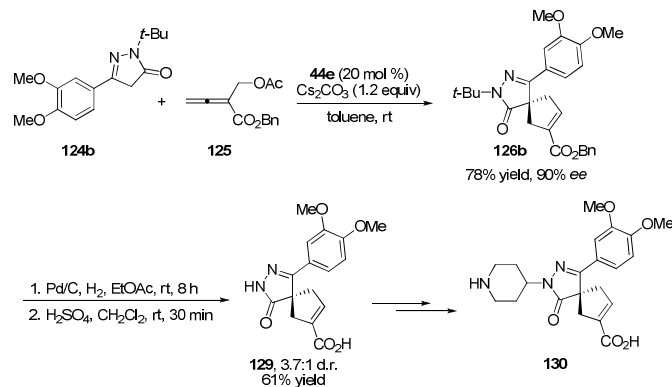

**Scheme 44** Synthesis of potential inhibitors of type-4 phosphodiesterase.

### 3.2 Cycloadditions of the MBH Adducts

Similar with allenoates, the readily available MBH adducts were shown to be able to act as a  $C_3$ -synthon in [3+2] cycloaddition and other annulations. Due to the distinct steric environment, their [3+2] annulations prefer to give the corresponding cyclic products with different regioselectivities compared to those employing allenoates. Lu and coworkers reported a stereoselective [3+2] cycloaddition between the MBH carbonates **132** and isatin-derived tetrasubstituted alkenes **131** catalysed by threonine-derived thiourea-phosphine **43a** for the first time (Scheme 45, up).<sup>41a</sup> This system offers a facile access to biologically imported 3-spirocyclopentene-2-oxindoles **133** with two contiguous quaternary centres with high regioselectivity and enantioselectivity. Additionally, a one-pot protocol proved to be equally effective, which made this method more synthetically appealing (Scheme 45, down).

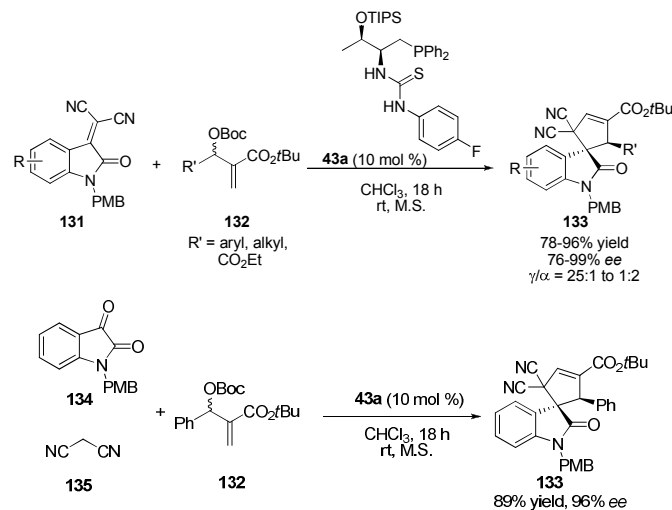

**Scheme 45** Enantioselective [3+2] cycloadditions of MBH adducts **132** with isatin-derived activated alkenes **131** mediated by L-threonine-derived phosphines **43a**.

Furthermore, the chiral dipeptide-based phosphine **48d** was found to be successfully application to the asymmetric [3+2] annulation of MBH carbonates **136** and maleimides **100**, which afforded diastereomerically pure and highly enantiomerically enriched bicyclic imides **137** in excellent yields (Scheme 46).<sup>41b</sup>

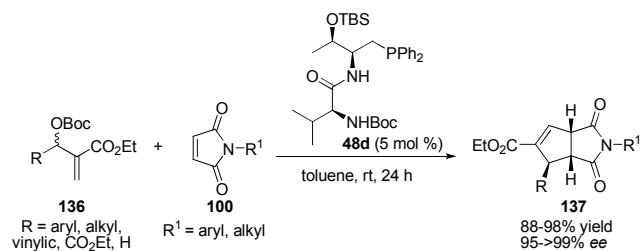

**Scheme 46** Enantioselective [3+2] cycloadditions of MBH adducts **136** with maleimides **100** mediated by dipeptide-based phosphines **48d**.

Shi group has done seminal contribution in asymmetric phosphine catalysed reactions. They demonstrated that the natural amino acid derived thiourea-phosphine **43b** exhibits the high catalytic performance in asymmetric [3+2] annulation of MBH carbonates **136** or **140** with various activated alkenes including 2-arylideneindane-1,3-diones **138**, maleimides **100** and trifluoroethylidenemalonates **142** (Scheme 47).<sup>16,42</sup> In these systems, the phosphine served as a nucleophile to initiate the reaction and the thiourea group or amide hydrogen served as a hydrogen-bonding donor to stabilize the in situ generated intermediate. Subsequently, Shi group has also developed an asymmetric [4+1] annulation of MBH adducts with dicyano-2-methylenebut-3-enoates using BINOL-derived multifunctional chiral phosphine as catalyst to give highly functionalized cyclopentenes in good yields with excellent enantioselectivities, in which the MBH adducts served as a new kind of 1,1-dipolar synthon.<sup>43</sup>

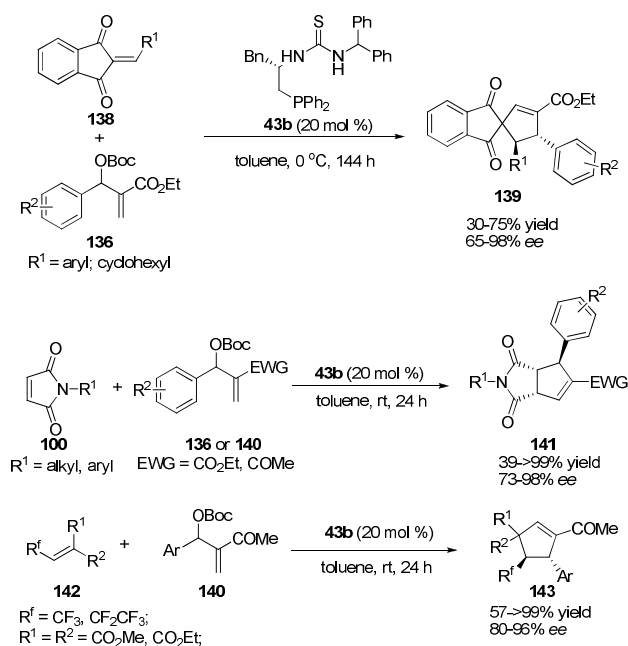

**Scheme 47** Enantioselective [3+2] cycloadditions of MBH adducts with activated alkenes mediated by chiral thiourea-phosphines **43b**.

### 3.3 (aza)-Morita-Baylis-Hillman Reactions

The Morita-Baylis-Hillman reaction has been one of the most important methods for converting simple starting materials to densely functionalized products in a catalytic and atom economic way.<sup>44</sup> The enantioselective versions of the MBH reactions have evolved dramatically over the past decade, with most of the significant advancements achieved by chiral amine catalysts. Besides, a series of bifunctional phosphine catalysts have been developed for the asymmetric MBH/aza-MBH reaction to achieve high enantioselectivity.

Wu showed that the enantioselective intramolecular MBH reactions of  $\omega$ -formyl- $\alpha,\beta$ -unsaturated carbonyl compounds **144** was catalysed by chiral phosphinothiourea **43c** and the cyclic MBH adducts **145** were obtained in up to 84% *ee* with good to excellent yields in dichloromethane at room temperature (Scheme 48).<sup>45</sup> The catalytic and chiral efficiency of L-valine derived phosphinothiourea **43d** was appreciated in the asymmetric MBH reaction of acrylates **146** with aldehydes **147**, affording the MBH adducts **148** in good enantioselectivities (up to 83% *ee*) and in moderate to excellent yields (up to 96%) (Scheme 49).<sup>46</sup> In this progress, only electron-poor aldehydes could be utilized.

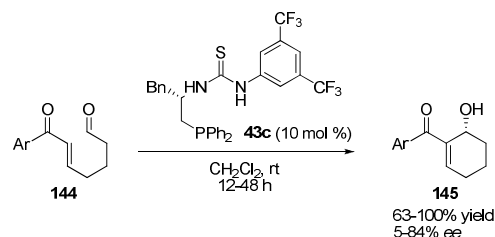

**Scheme 48** Enantioselective intramolecular Morita-Baylis-Hillman reaction mediated by phosphinothiourea **43c**.

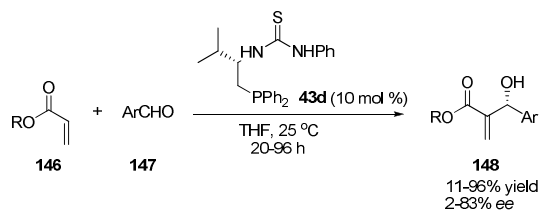

**Scheme 49** Enantioselective Morita-Baylis-Hillman reaction of acrylates with aldehydes mediated by phosphinothiourea **43d**.

Later, Lu group designed and prepared a series of phosphinothiourea organic catalysts based on the structural scaffolds of natural amino acids. In particular, L-threonine-derived bifunctional phosphine **43e** was prepared for the first time and found to be an effective catalyst for the enantioselective MBH reaction of acrylates with aldehydes (Scheme 50).<sup>47</sup> The corresponding adducts were obtained in high yield and with good *ee* values (up to 90% *ee*). The reaction was applicable to a wide range of aromatic aldehydes with different substitution patterns and electronic properties at the aryl rings.

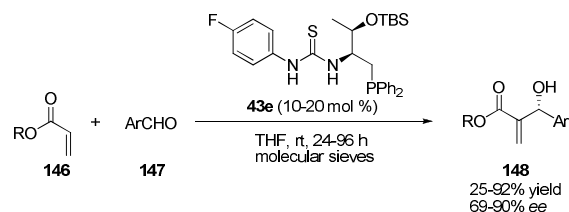

**Scheme 50** Enantioselective Morita-Baylis-Hillman reaction of acrylates with aldehydes mediated by phosphinothiourea **43e**.

Lu expanded an enantioselective aza-MBH reaction between *N*-(*p*-methoxybenzenesulfonyl) imines **149** and acrylates **146** by using a novel L-threonine-derived phosphine-sulfoamide catalyst **30f**, affording the products in good yields (76-96%) and with good to excellent *ee* (88-97%) (Scheme 51).<sup>48a</sup> Density functional theory (DFT) studies were carried out to elucidate the origin of the observed enantioselectivity.<sup>48b</sup> The importance of the intramolecular N-H...O hydrogen bonding interaction between the sulfonamide and enolate groups was identified to be crucial in inducing a high degree of stereochemical control in both enolate addition to imine and the subsequent proton transfer step.

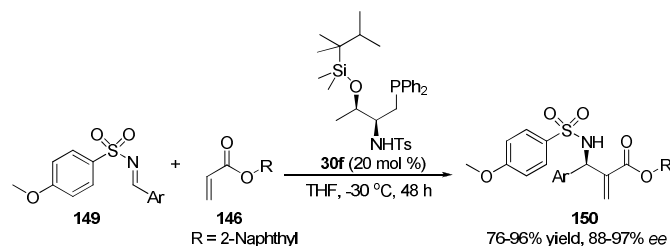

**Scheme 51** Asymmetric aza-Morita-Baylis-Hillman reaction of various imines **149** with acrylate **146** mediated by **30f**.

Shi and co-workers also devoted their efforts for the development of the catalytic asymmetric aza-Morita-Baylis-Hillman reaction of *N*-sulfonated imines with vinyl ketones using chiral BINOL-derived bifunctional phosphines as catalysts.<sup>49</sup> Recently, they have reported the asymmetric aza-MBH reaction of 2-indolyl sulfonated imines **151** with electron-deficient olefins **146** in the presence of thiourea-phosphine catalyst **43b** (Scheme 52).<sup>50</sup> These multifunctional MBH adducts **152** were obtained in good yields and *ee* values, which could be applied to synthesize enantiomerically enriched dihydropyrido[1,2-*a*]-indole and dihydropyrazino[1,2-*a*]indole derivatives.

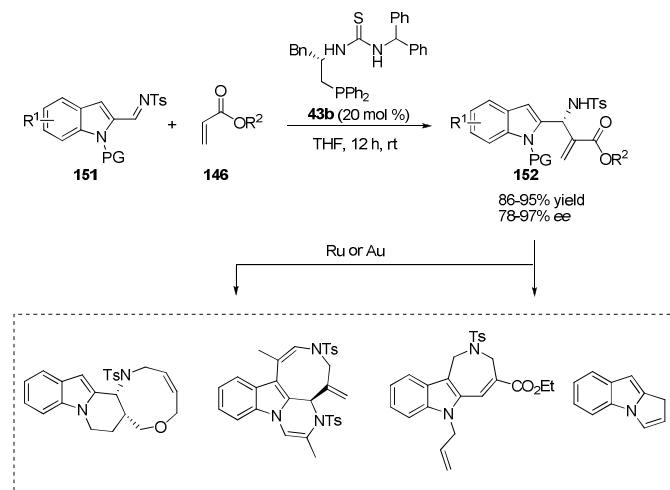

**Scheme 52** Catalytic Asymmetric aza-MBH reaction of 2-indolyl sulfonated imines **151** with acrylate **146** mediated by **43b**.

### 3.4 Rauhut-Currier reactions and related cycloadditions

The Rauhut-Currier (RC) reaction, also known as the vinylogous Morita-Baylis-Hillman reaction, involves coupling of one active alkene/latent enolate to a second Michael acceptor, creating a new C-C bond between the  $\alpha$ -position of one activated alkene and the  $\beta$ -position of a second alkene under the influence of a nucleophilic catalyst.<sup>51</sup> Much pioneering work were made to develop the enantioselective (aza)-Rauhut-Currier reaction using chiral catalysts. L-valine-derived phosphinothiourea **43f** was used in the intramolecular Rauhut-Currier reaction of bis(enones) **153** as the catalyst for the first time by Wu.<sup>52</sup> The catalytic system was highly efficient and the desired products were obtained in good yields (up to 99%) with excellent enantioselectivities (up to 99.4% *ee*) (Scheme 53).

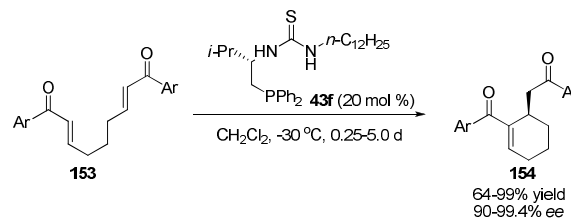

**Scheme 53** Asymmetric intramolecular Rauhut-Currier reaction of symmetrical bis(enone) **153**.

In 2012, Sasai reported an interesting desymmetrization reaction of the prochiral dienones **155** (Scheme 54).<sup>53</sup> Catalyst **30a** has been shown useful in this intramolecular Rauhut-Currier reaction giving rise to  $\alpha$ -methylene- $\gamma$ -butyrolactones **156** as a single diastereomer in *ee*'s up to 98%. Notably, the proton-transfer step from the  $\alpha$  position of a carbonyl group of the lactone to the enolate anion is supposed to be the rate determining step.

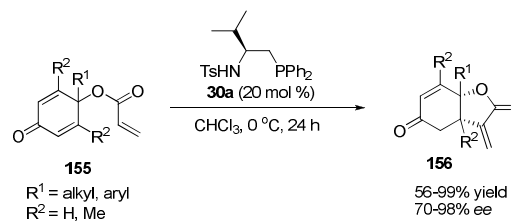

**Scheme 54** Asymmetric intramolecular Rauhut-Currier reaction of the prochiral dienone **155** mediated by **30a**.

Using chiral sulfinamide phosphine catalyst (Xiao-Phos), our group recently reported the same intramolecular Rauhut-Currier reaction of 4-oxocyclohexa-2,5-dienyl acrylate **155**, generating  $\alpha$ -methylene- $\gamma$ -butyrolactones **156** in good yields with up to 99% *ee* (Scheme 55).<sup>20</sup> Importantly, this method provides an efficient access to synthesis of both (+) and (-)-**156** by simply switching the geometry of the catalyst **52a**. Furthermore, a nice kinetic resolution process with a high *s* factor (*s* = 95) was observed in the reaction of *rac*-**157**, furnishing the desired (+)-**158** in 46% yield with 96% *ee* and the (*S*)-**157** could be recovered in 51% yield with 90% *ee* (Scheme 56, up). Notably, an exciting parallel kinetic resolution of *rac*-**155** was realized and enantioenriched (+)-**156** and (+)-**159** could be obtained in satisfied yield and with high enantioselectivity (Scheme 56, down). This is the first successful example of a parallel kinetic resolution in the Rauhut-Currier reaction.

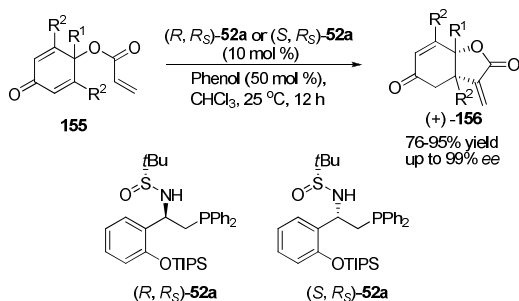

**Scheme 55** Asymmetric intramolecular Rauhut-Currier reaction of 4-oxocyclohexa-2,5-dienyl acrylate **155** mediated by Xiao-Phos **52a**.

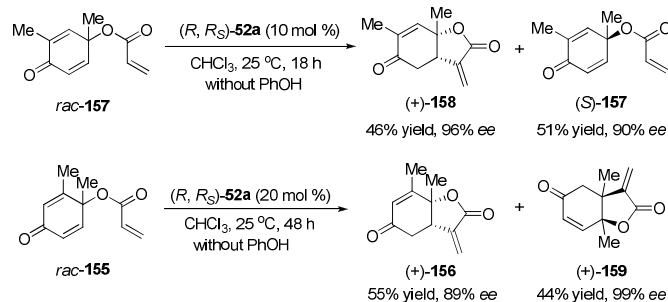

**Scheme 56** Kinetic resolution of *rac*-**157** and parallel kinetic resolution of *rac*-**155**.

It is not surprising that new instances are continuing to appear in the literature, in particular, application chiral aminophosphine organocatalysts in the more challenging intermolecular Rauhut-Currier reaction. Huang's group first developed a highly enantioselective intermolecular cross RC reaction of different active olefins to produce the desired products **162** in high yields (51-98%) and with excellent enantioselectivities (69-96% *ee*) (Scheme 57).<sup>54</sup> With the new catalyst **44g**, the zwitterion formed by the phosphine and vinyl ketone is stabilized by the hydrogen bonding between the phenolic hydroxyl group and the acid amide group (Scheme 58). The reaction could be performed on a gram scale using 1 mol % of the multifunctional aminophosphine catalyst **44g**. Very recently, Zhao, Zhang and co-workers applied their developed the novel chiral sulfinamide bisphosphine (*S,R,S*)-**52b** to the similar highly enantioselective intermolecular cross RC reactions of vinyl ketone **160** and 3-acyl acrylates **161**.<sup>55</sup> Notably, this chiral phosphine-catalysed asymmetric RC reaction was not only suitable for 3-acyl acrylates, but also for 2-ene-1,4-diones. The corresponding RC products were gained in high yields with up to 99% *ee* under 2.5 mol% catalyst loading.

Merging an intermolecular RC reaction with subsequent reactions in a cascade reaction could form a series of optically active heterocycles. Chi demonstrated the power of chiral amino phosphine catalyst by the application to intramolecular aza formal [2+4] reaction between  $\alpha,\beta$ -unsaturated imines and electron-deficient alkenes through a tandem Rauhut-Currier/ $S_N2$ -substitution sequence.<sup>56</sup> The nitrogen-containing heterocyclic products **164** were obtained in excellent enantioselectivities as essentially single diastereomers (Scheme 59).

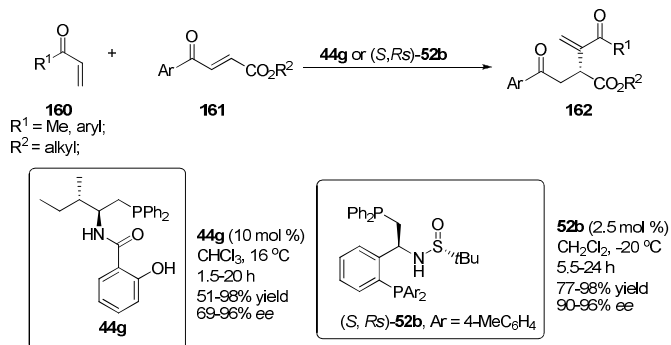

**Scheme 57** Enantioselective intermolecular Rauhut-Currier reaction of 3-aryl acrylates **161** and vinyl ketones **160**.

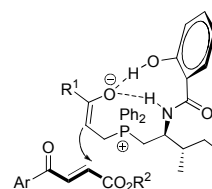

**Scheme 58** Proposed transition state model for the RC reaction.

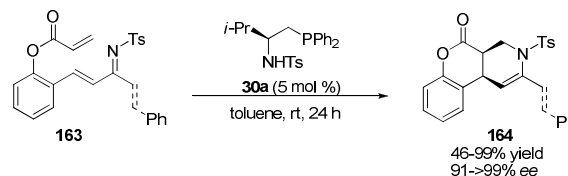

**Scheme 59** Enantioselective intramolecular formal [2+4] annulation of acrylates and  $\alpha,\beta$ -unsaturated imines.

At the same time, Zhong achieved the catalytic asymmetric intermolecular [4+2] annulation of vinyl ketone with *N*-sulfonyl-1-aza-1,3-dienes initiated by an aza-Rauhut-Currier reaction using the chiral phosphine catalyst **44f** derived from L-leucine (Scheme 60).<sup>57</sup> The resulting tetrahydropyridine adducts **166/168** were generated with exclusively *trans* diastereoselectivity and excellent enantioselectivity in good to excellent chemical yields.

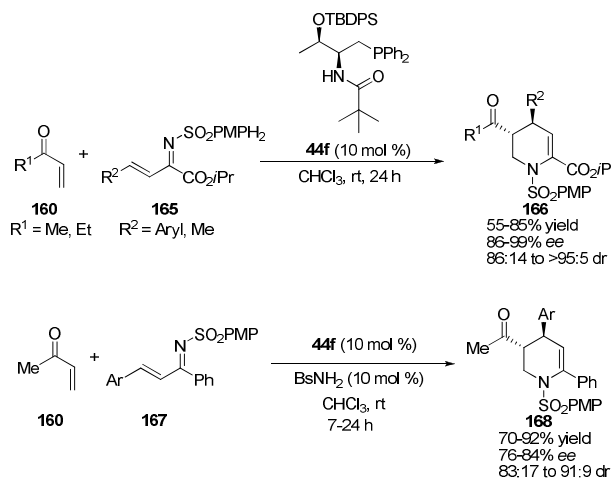

**Scheme 60** Asymmetric intermolecular [4+2] annulation of enones **160** and  $\alpha,\beta$ -unsaturated imines **165/167**.

Shi et al. utilized a similar strategy for the stereoselective synthesis of substituted six-membered heterocyclic spirooxindoles.<sup>58</sup> Their report described the detailed study of the asymmetric intermolecular [4+2] annulation of vinyl ketones with various oxindole-derived  $\alpha,\beta$ -unsaturated imines in the presence of two kinds of phosphinothiourea catalysts **43g/43h**, which provided isatin-based spiro-fused six-membered heterocycles **170/172** in moderate to good yields with high enantioselectivities (Scheme 61).

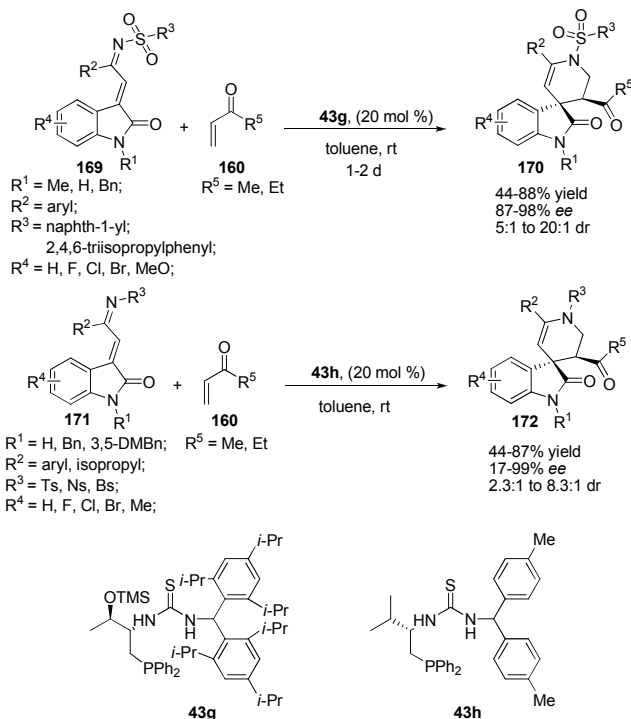

**Scheme 61** Enantioselective intramolecular formal [2+4] annulation of acrylates **160** and  $\alpha,\beta$ -unsaturated imines **169/171**.

### 3.5 Other reactions

Organocatalytic asymmetric allylic alkylations of MBH adduct with various nucleophiles have been intensively investigated using chiral phosphine based on BINOL backbone by Shi.<sup>59</sup> The reactions provided a practical access to a variety of biologically interesting substances. Recently, Lu developed the asymmetric allylic alkylations using phthalides **173** as nucleophiles for the first time to provide optically enriched 3,3-disubstituted phthalides **174** (Scheme 62).<sup>60</sup> The sterically hindered silyloxy groups and the hydrogen bonding interactions between the thiourea moiety of the catalyst **43a** and the ester group of phthalide **173** were crucial for the observed stereoselectivity.

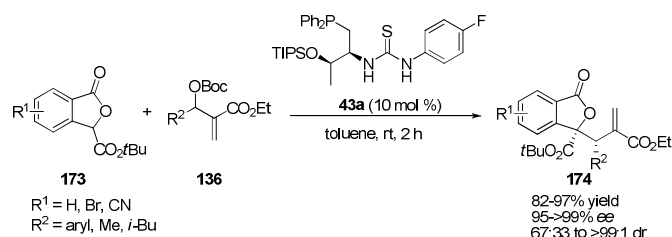

**Scheme 62** Enantioselective allylic alkylation of MBH adducts **136** and phthalides **173**.

Nucleophilic catalysis with chiral phosphines has captured considerable attention in recent years; however, very little attention was paid to the conceptually simple asymmetric Michael addition. Lu and coworkers reported the first highly enantioselective Michael additions of oxindoles **175** that were mediated by chiral phosphine catalysts **44b** derived from amino acids (Scheme 63).<sup>61</sup> They proposed that the hydrogen-bonding interaction between the amide NH and the enolate oxygen atom of the nucleophile facilitates formation of the nucleophile-phosphonium ion pair, and makes the latter more structurally defined. The presence of the 3,5- $\text{CF}_3$ -substituted phenyl ring blocks the *Re* face and makes the approach of the incoming electrophile from the *Si* face more favorable. In this context, they put forward the concept that the phosphonium enolate intermediate which was generated upon phosphine addition of an alkene or allene could be utilized for the activation of pronucleophiles.

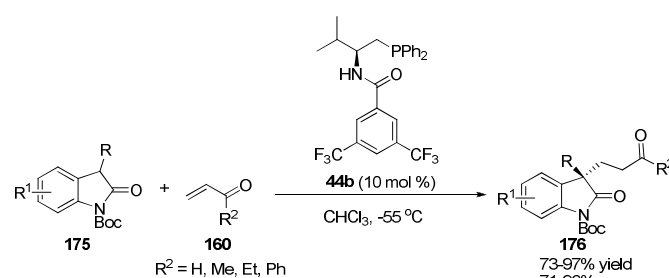

**Scheme 63** Asymmetric Michael addition of oxindoles **175** to activated alkenes **160**.

Later, they used the same concept to achieve the first phosphine-catalysed asymmetric  $\gamma$ -addition of prochiral nucleophiles to allenoates in high yields and excellent enantioselectivity (Scheme 64).<sup>62</sup> This process enabled the formation of oxindole derivatives **177** with an all-carbon quaternary stereogenic centre at the 3-position and was applied in the formal total synthesis of natural products. Adduct **177a** could be transformed into aldehyde **179** in a high yield through a few simple transformations (Scheme 65). The known aldehyde **179** can be converted into (-)-esermethole and (-)-physostigmine according to literature precedents.<sup>63</sup>

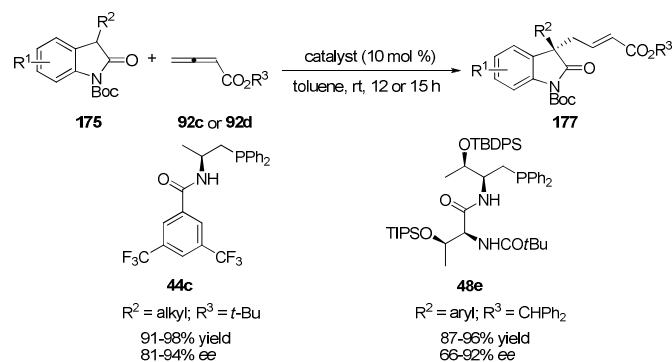

**Scheme 64** Enantioselective  $\gamma$ -addition of allenoates **92** with oxindoles **175** catalysed by bifunctional aminophosphines **44c/48e**.

In addition, the  $\gamma$ -addition adducts offer great opportunities for further structural elaborations. As shown in Scheme 66(A), the  $\gamma$ -addition adduct **177b** could be converted into amide **182**





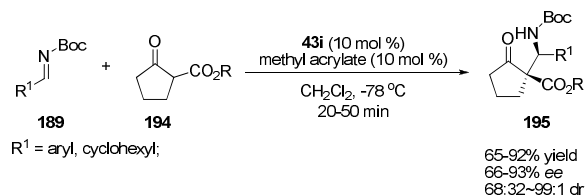

**Scheme 70** Asymmetric Mannich reaction of *N*-Boc imines **189** and cyclic  $\beta$ -ketoester **194** under the catalysis of  $\beta$ -aminophosphine **43i**.

Most recently, an efficient enantioselective cycloaddition of cyclobutenones and isatylidenemalononitriles triggered by chiral  $\beta$ -aminophosphine catalysed C-C activation has been reported by our group for the first time (Scheme 71).<sup>68</sup> Spirocyclo-oxindole derivatives **198** were synthesized in 77-98% yield with 75-87% *ee*. In this reaction, the NaI may play as the counterion to stabilize the zwitterionic intermediate formed by nucleophilic 1,2-addition of the phosphine to cyclobutenone.

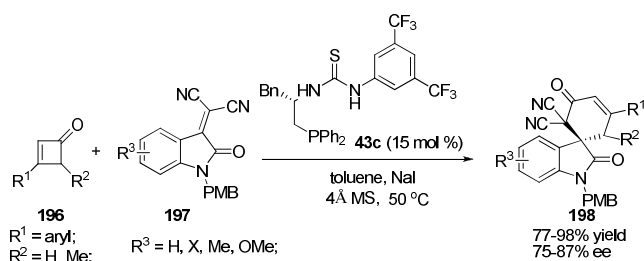

**Scheme 71** Enantioselective 1,4-dipolar spiroannulation of cyclobutenone **196** and isatylidenemalononitrile **197**.

### 3.6 Chiral phase-transfer catalysis

Chiral phase-transfer catalysis is an essential and powerful tool for the synthesis of chiral organic compounds at both academic and industrial levels. Zhao and co-workers reported an aza-Henry reaction using a novel chiral bifunctional quaternary phosphonium salts **199** based on natural amino acids as highly efficient phase-transfer catalyst (Scheme 72).<sup>69</sup> In this reaction, phosphonium salts **199** would be suitable catalysts by formation of ion pairs between the phosphonium ions and the deprotonated substrates, and interactions between amide functionality in **199** and hydrogen-bonding site in the substrates. Specifically, when R in **200** was aromatic, heteroaromatic or aliphatic groups, good to excellent yields and excellent *ee* were generally obtained. The method was applied to the synthesis of a chiral amino-substituted  $\gamma$ -lactam **204**, an important structural motif found in many physiologically active substances (Scheme 73).

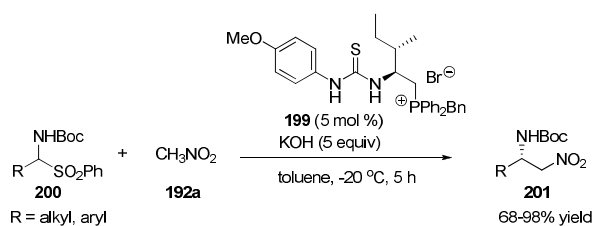

**Scheme 72** Asymmetric aza-Henry reaction catalysed by thiourea-phosphonium salts **199**.

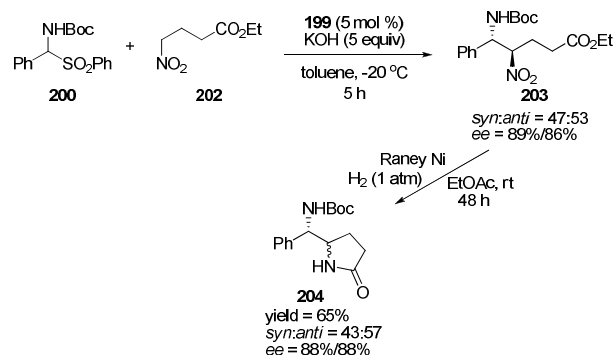

**Scheme 73** Asymmetric synthesis of amino-substituted  $\gamma$ -lactam **197** via an asymmetric aza-Henry reaction.

Following this work, the same group applied the efficient phase-transfer catalyst **205** with phosphonium centre to the asymmetric Michael additions of 3-monosubstituted oxindoles to methyl vinyl ketone or acrolein to afford 3,3-disubstituted oxindoles in good to excellent yields with moderate to excellent *ees* (Scheme 74).<sup>70</sup>

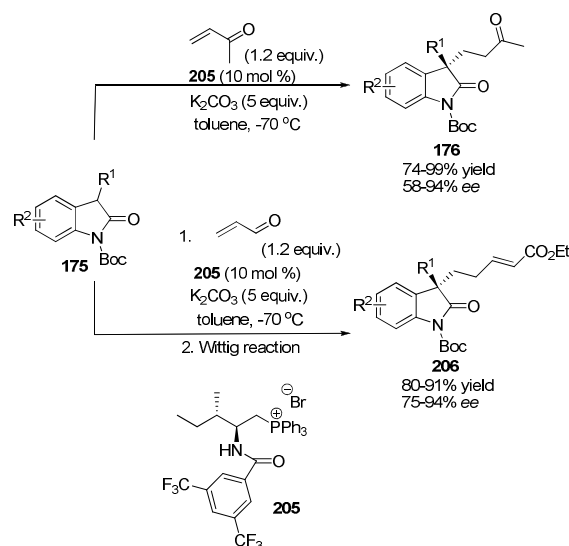

**Scheme 74** Asymmetric Michael addition of oxindoles **175** to activated alkenes catalysed by amino acid-derived phosphonium salts **205**.

## 4. Chiral *N,P*-ligand in asymmetric metal-catalysed process

Chiral phosphorus ligands have earned a prominent status, shown by their multitasking application in a large number of asymmetric catalytic reactions. Chiral amino-phosphines based on an amino acid template may be interesting as chiral ligands for metal catalysed reactions.<sup>71</sup> From the reactivity standpoint, a *N,P*-ligand contains a combination of hard (nitrogen) and soft (phosphorus) centres. Within this environment, metal ions can be stabilized in their low oxidation states by the  $\pi$ -accepting character of the softer phosphorus site. On the other hand, high oxidation states are better stabilized by the harder nitrogen site. This combination can help to stabilise intermediate oxidation states or geometries formed during a catalytic cycle.

In 1980, Hayashi and Kumada reported one of the first applications of chiral *N,P*-ligands in asymmetric catalysis.<sup>29</sup>

The use of *N,N*-dialkyl  $\beta$ -aminophosphine **78** as ligand promoted nickel-catalysed Grignard cross-coupling between 1-phenylethyl magnesium chloride **207** and vinyl bromide **208** with moderate to good enantioselectivities (Scheme 75). The asymmetric induction is thought to result from dissociation of the nitrogen from the metal during the reaction to selectively bind one enantiomer of the racemic Grignard and then direct it onto the metal.

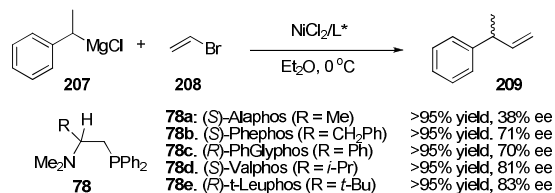

**Scheme 75** Nickel-catalysed asymmetric Grignard cross-coupling between 1-phenylethylmagnesium chloride **207** and vinyl bromide **208**.

Kellogg synthesized a variety of amino acid-derived ligands possessing different length of spacer such as **210a–210c**, which were also used in the coupling of vinyl bromide with the Grignard reagent.<sup>72</sup> The cross-coupling product from 1-phenylethylmagnesium chloride **207** and vinyl bromide **208** was formed with 88% enantiomeric excess using ligand **210c**. The chiral ligands **210a–210b** were further applied in the rhodium-catalysed hydrosilylation of acetophenone **211** by Fallor, which gave the expected *sec*-phenethyl alcohol **213** in up to 62% *ee* (Scheme 76).<sup>73</sup>

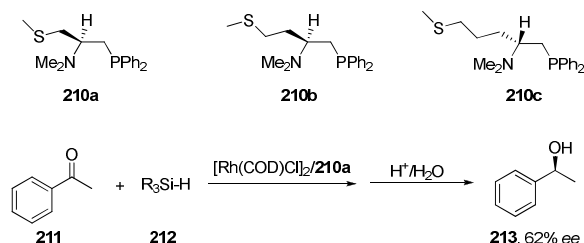

**Scheme 76** Enantioselective hydrosilylation of acetophenone **211** with **L210**/[Rh(COD)Cl]<sub>2</sub>.

Nitrogen-phosphorus chelate ligands are amongst the most successful in the palladium catalysed asymmetric allylic substitution reaction. Anderson et al. employed four nitrogen-phosphorus ligands derived from (*S*)-valine in the palladium catalysed allylic substitution reaction to give dramatically different enantioselectivities, ranging from 92% *ee* (*R*) to 83% *ee* (*S*) (Scheme 77).<sup>30</sup> An important feature of **84** and **79** is the potential for the chirality of the backbone to induce a preferential orientation of the amino substituents upon binding to the metal and hence rendering the nitrogen stereogenic.

Uenishi et al. synthesized the new *N, P*-ligands **217–218** containing 1-(2-pyridinyl)ethylamine derivatives, and applied them to the allylic alkylation of 1,3-diphenyl-2-propenyl acetate (Scheme 78).<sup>74</sup> The highest enantioselectivity (86% *ee*) was obtained with **217d**, showing that the pyrrolidine chiral centre is the major influence on the enantioselection.

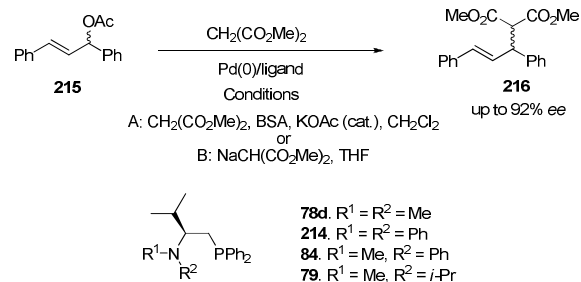

**Scheme 77** Palladium-mediated asymmetric allylic substitution with chiral *N, P*-Ligand derived from (*S*)-valine.

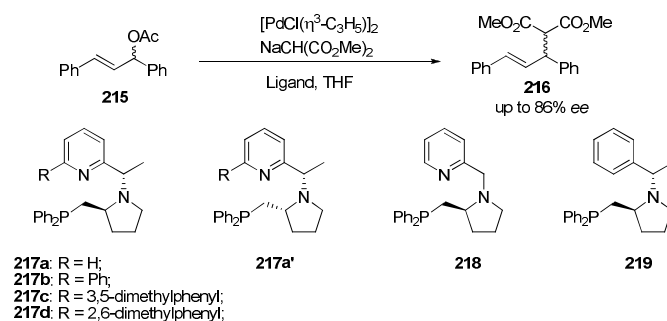

**Scheme 78** Palladium-mediated asymmetric allylic alkylation with chiral pyridine-phosphine ligands.

Saitoh et al. have prepared amino acid valine-derived ligands **220–222** with *sp*<sup>2</sup>-hybridized nitrogen atom, which provided sterically and electronically different chiral circumstances and were used for the palladium-mediated asymmetric allylic substitutions of acyclic compounds (Scheme 79).<sup>75</sup>

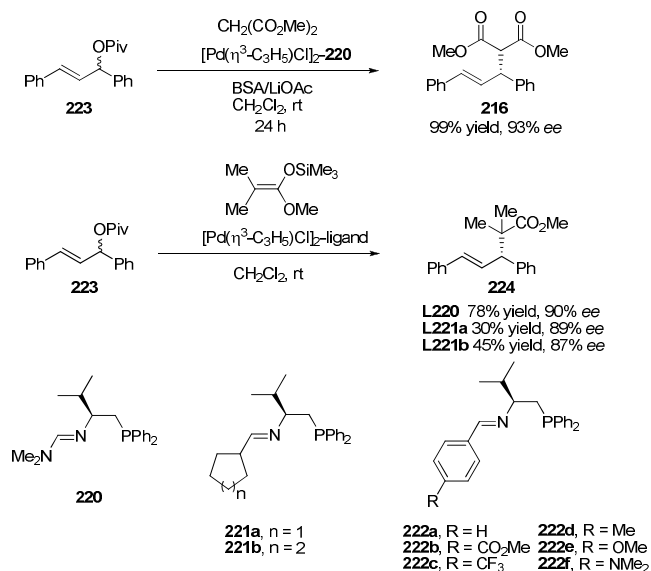

**Scheme 79** Enantioselective allylic substitutions catalysed by a palladium-chiral amidine complex.

Gilbertson group tested a series of peptide-based bisphosphine ligands **225** to promote the palladium-catalysed addition of cyclic allyl acetates **226** (Scheme 80).<sup>76</sup> The best result was obtained when using the ligand with R = 3,5-xylene in THF at 0 °C, resulting in the final product **227** (n = 1) in 91% yield and 95% *ee*.

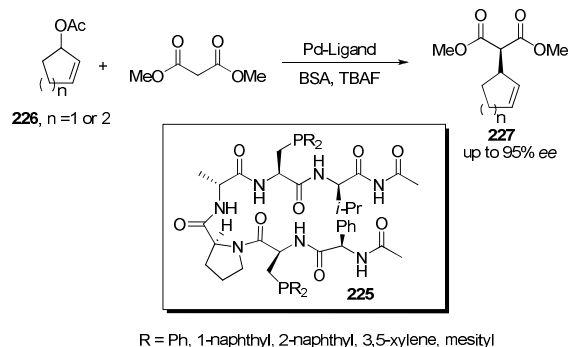

**Scheme 80** Palladium-mediated asymmetric addition of cyclic allyl acetates with peptide-based bisphosphine ligands **225**.

The 1,4-addition of organometallic reagents to  $\alpha,\beta$ -unsaturated carbonyl or related compounds is an important method for carbon-carbon bond formation. Morimoto applied *N, P*-ligands to enantioselective copper-catalysed conjugated addition of diethylzinc to cyclohexenone.<sup>77</sup> The best result (91% *ee*) was obtained with ligand **228** and the products **233** were obtained in 40% and 83% *ee* with ligands **229** and **230**, respectively (Scheme 81). For acyclic enone, the corresponding  $\beta$ -ethylation product **234** was gained in better enantioselectivity (81% *ee*) with ligand **230** reported by Malkov (Scheme 82).<sup>31</sup> Malkov considered that the coordination of the pyridine and phosphine groups to the metal would result in the formation of an eight-membered ring and the tertiary amide group could relay the chiral information from the ligand backbone to the active centre.

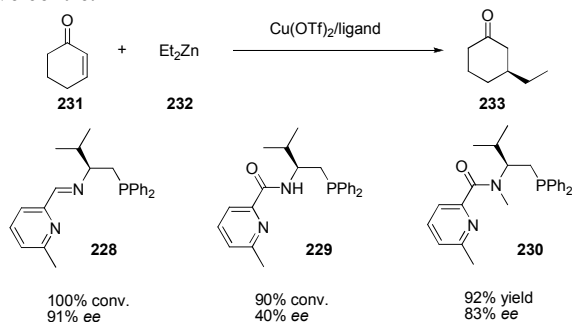

**Scheme 81** Enantioselective copper-catalysed 1,4-addition of diethylzinc to cyclohexenone.

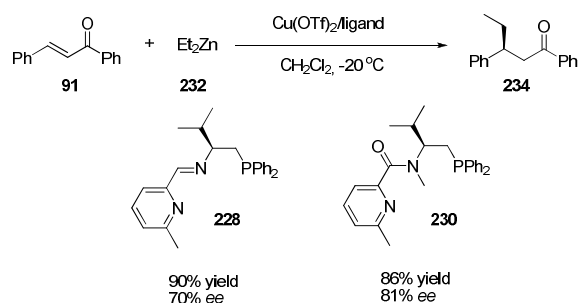

**Scheme 82** Enantioselective copper-catalysed 1,4-addition of diethylzinc to acyclic enone.

Leighton and co-workers reported the use of new ligand **30g** for Cu-catalysed enantioselective additions of dialkylzincs **236** to cyclic enones **235** with good yields and enantioselectivities (Scheme 83).<sup>13</sup> The substitution of triflamide in the ligand **30g** led to a more enantioselective reaction. 2-Cyclohexen-1-ones

were consistently engaged in highly enantioselective reactions with a range of dialkylzinc reagents, albeit not with dimethylzinc.

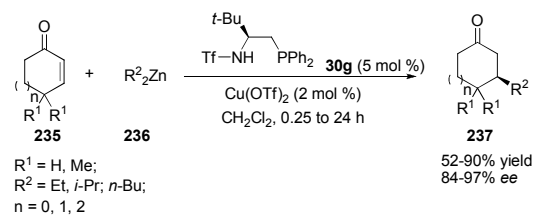

**Scheme 83** Enantioselective 1,4-addition of dialkylzinc to cyclic enones catalysed by a copper-phosphine sulfonamide complex.

Recently, the *N,N,P*-tridentate ligands **238** were also used to promote the highly enantioselective 1,4-addition of dialkylzinc to enones (up to 99% *ee*) in combination with  $\text{Cu}(\text{OTf})_2$  (Scheme 84).<sup>78</sup>

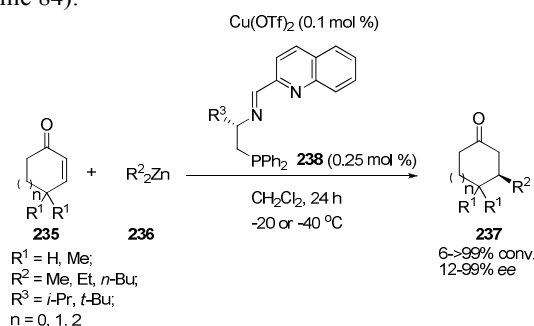

**Scheme 84** Enantioselective copper-catalysed 1,4-addition of dialkylzinc to cyclic enones with a *N,N,P*-tridentate ligands **238**.

## 5. Conclusions

The development of chiral phosphine catalysts or ligands based on the skeletons of natural amino acids has seen remarkable progress in recent years. The carboxylic acid group can be easily converted to a phosphine, which is expected to be highly nucleophilic as the phosphorus atom is connected to a primary carbon. Besides, methods such as the addition of  $\text{Ph}_2\text{PCH}_2\text{Li}$  to chiral sulfinimines and the decarboxylation of 2-oxazolidinones provide easy access to the synthesis of enantiopure  $\beta$ -aminophosphine derivatives. It is well understood that structural diversity plays a key role in catalyst design since subtle structural alterations in a catalyst might cause drastic changes in the outcome of a catalytic process.

As we have shown in this review, chiral  $\beta$ -aminophosphine derivatives participated organocatalytic, phase-transfer catalytic and organometallic reactions have been developed, including cycloadditions, (aza)-Morita-Baylis-Hillman reactions, Rauhut-Currier reaction and related reactions, aza-Henry reaction, allylic alkylations, Pd-catalysed allylic substitution reaction, Cu-catalysed 1,4-addition reactions, *etc.* Excellent enantioselectivities, regioselectivities and reactivities have been achieved in each of these processes. Clearly, the highlighted methodologies have several drawbacks, including poor structural diversity and limited group compatibility. Yet, the achievements with these methodologies have been immense. It is highly desirable to further extend the utility of amino phosphine catalysts or ligands to other important organic reactions.

## Acknowledgements

We are grateful to 973 Programs (2011CB808600), the National Natural Science Foundation of China (21372084, 21425205), and Changjiang Scholars and Innovative Research Team in University (PCSIRT) for financial supports.

## Notes and references

- (a) E. N. Jacobsen, A. Pfaltz and H. Yamamoto, *Comprehensive Asymmetric Catalysis*, Springer, New York, 1999. (b) I. Ojima, *Catalytic Asymmetric Synthesis*, 3rd ed., Wiley, Hoboken, NJ, 2010.
- For reviews on phosphine catalysis, see: (a) Y. C. Fan and O. Kwon, *Chem. Commun.*, 2013, **49**, 11588; (b) Q.-Y. Zhao, Z. Lian, Y. Wei and M. Shi, *Chem. Commun.*, 2012, **48**, 1724; (c) S.-X. Wang, X. Han, F. Zhong and Y. Lu, *Synlett*, 2011, 2766; (d) A. Marinetti and A. Voituriez, *Synlett*, 2010, 174; (e) B. J. Cowen and S. J. Miller, *Chem. Soc. Rev.*, 2009, **38**, 3102; (f) L.-W. Ye, J. Zhou and Y. Tang, *Chem. Soc. Rev.*, 2008, **37**, 1140; (g) J. L. Methot and W. R. Roush, *Adv. Synth. Catal.*, 2004, **346**, 1035; (h) X. Lu, C. Zhang and Z. Xu, *Acc. Chem. Res.*, 2001, **34**, 535.
- For a recent review on multifunctional chiral phosphine organocatalysts, see: (a) Y. Wei and M. Shi, *Acc. Chem. Res.*, 2010, **43**, 1005. (b) Y. Wei and M. Shi, *Chem. Asian J.*, 2014, **9**, 2720.
- (a) A. G. Doyle and E. N. Jacobsen, *Chem. Rev.*, 2007, **107**, 5713. (b) P. S. Bhadury, B.-A. Song, S. Yang, D.-Y. Hu and W. Xue, *Curr. Org. Synth.*, 2009, **6**, 380.
- (a) S.-X. Wang, X. Han, F. Zhong, Y. Wang and Y. Lu, *Synlett*, 2011, **19**, 2766. (b) L.-W. Xu, *ChemCatChem*, 2013, **5**, 2775.
- (a) T. P. Yoon and E. N. Jacobsen, *Science*, 2003, **299**, 1691. (b) Q.-L. Zhou, Ed. *Privileged Chiral Ligands and Catalysts*; Wiley-VCH: Weinheim, 2011.
- (a) A. Saitoh, T. Morimoto and K. Achiwa, *Tetrahedron: Asymmetry*, 1997, **8**, 3567; (b) A. Saitoh, T. Uda and T. Morimoto, *Tetrahedron: Asymmetry*, 1999, **10**, 4501.
- R. Guo, S. Lu, X. Chen, C.-W. Tsang, W. Jia, C. Sui-Seng, D. Amoroso and K. Adbur-Rashid, *J. Org. Chem.*, 2010, **75**, 937.
- X. Han, Y. Wang, F. Zhong and Y. Lu, *J. Am. Chem. Soc.*, 2011, **133**, 1726.
- G. T. Kelly, V. Sharma and C. M. H. Watanabe, *Bioorganic Chemistry*, 2008, **36**, 4.
- A. Caiazzo, S. Dalili and A. K. Yudin, *Org. Lett.*, 2002, **4**, 2597.
- X. Fu, Z. Jiang and C.-H. Tan, *Chem. Commun.*, 2007, 5058.
- I. J. Krauss and J. L. Leighton, *Org. Lett.*, 2003, **5**, 3201.
- P. Rönholm, M. Södergren and G. Hilmersson, *Org. Lett.*, 2007, **9**, 3781.
- Y.-Q. Fang and E. N. Jacobsen, *J. Am. Chem. Soc.*, 2008, **130**, 5660.
- H.-P. Deng, Y. Wei and M. Shi, *Adv. Synth. Catal.*, 2012, **354**, 783.
- H. Xiao, Z. Chai, C.-W. Zheng, Y.-Q. Yang, W. Liu, J.-K. Zhang and G. Zhao, *Angew. Chem. Int. Ed.*, 2010, **49**, 4467.
- M. Quirnbach, J. Holz, V. I. Tararov and A. Börner, *Tetrahedron*, 2000, **56**, 775.
- M. Ito, A. Osaku, C. Kobayashi, A. Shiibashi and T. Ikariya, *Organometallics*, 2009, **28**, 390.
- X. Su, W. Zhou, Y. Li and J. Zhang, *Angew. Chem. Int. Ed.*, 2015, **54**, 6874.
- A. Sato, H. Yorimitsu and K. Oshima, *J. Am. Chem. Soc.*, 2006, **128**, 4240.
- S. R. Gilbertson, G. Chen and M. McLoughlin, *J. Am. Chem. Soc.*, 1994, **116**, 4481.
- (a) J. Omelanczuk and M. Mikolajczyk, *Tetrahedron Lett.*, 1984, **25**, 2493. (b) S. R. Gilbertson and X. Wang, *J. Org. Chem.*, 1996, **61**, 434. (c) S. R. Gilbertson, X. Wang, G. S. Hoge, C. A. Klug and J. Schaefer, *Organometallics*, 1996, **15**, 4678. (d) S. R. Gilbertson and X. Wang, *Tetrahedron Lett.*, 1996, **37**, 6475.
- (a) F. Langer, K. Püntener, R. Sturmer and P. Knochel, *Tetrahedron: Asymmetry*, 1997, **8**, 715. (b) P. Knochel, M. C. P. Yeh, S. C. Berk and J. Talbert, *J. Org. Chem.*, 1988, **53**, 2390. (c) S. J. Greenfield and S. R. Gilbertson, *Synthesis*, 2001, **15**, 2337. (d) S. J. Greenfield, A. Agarkov and S. R. Gilbertson, *Org. Lett.*, 2003, **5**, 3069.
- D. J. Brauer, K. W. Kottsieper, S. Schenk and O. Z. Stelzer, *Anorg. Allg. Chem.*, 2001, **627**, 1151.
- A. M. Porte, W. A. van der Donk and K. Burgess, *J. Org. Chem.*, 1998, **63**, 5262.
- J. K. Stille, H. Su, P. Brechot, G. Parrinello and L. S. Hegedus, *Organometallics*, 1991, **10**, 1183.
- (a) S. R. Gilbertson and D. Xie, *Angew. Chem. Int. Ed.*, 1999, **38**, 2750. (b) A. Agarkov, S. J. Greenfield, D. Xie, R. Pawlick, G. Starkey and S. R. Gilbertson, *Biopolymers*, 2006, **84**, 48.
- (a) T. Hayashi, M. Fukushima, M. Konishi and M. Kumada, *Tetrahedron Lett.*, 1980, **21**, 79. (b) T. Hayashi, M. Konishi, M. Fukushima, K. Kanehira, T. Hioki and M. Kumada, *J. Org. Chem.*, 1983, **48**, 2195.
- (a) J. C. Anderson, R. J. Cubbon and J. D. Harling, *Tetrahedron: Asymmetry*, 2001, **12**, 923. (b) J. C. Anderson, R. J. Cubbon and J. D. Harling, *Tetrahedron: Asymmetry*, 1999, **10**, 2829.
- A. V. Malkov, J. B. Hand and P. Kočovský, *Chem. Commun.*, 2003, 1948.
- B. J. Cowen and S. J. Miller, *J. Am. Chem. Soc.*, 2007, **129**, 10988.
- (a) X. Han, Y. Wang, F. Zhong and Y. Lu, *Synthesis*, 2011, **12**, 1859. (b) Q. Zhao, X. Han, Y. Wei, M. Shi and Y. Lu, *Chem. Commun.*, 2012, **48**, 970.
- S. R. Yong, M. C. Williams, S. G. Pyne, A. T. Ung, B. W. Skelton, A. H. White and P. Turner, *Tetrahedron*, 2005, **61**, 8120.
- X. Han, F. Zhong, Y. Wang and Y. Lu, *Angew. Chem. Int. Ed.*, 2012, **51**, 767.
- H. Yu, L. Zhang, Z. Yang, Z. Li, Y. Zhao, Y. Xiao and H. Guo, *J. Org. Chem.*, 2013, **78**, 8427.
- H. Xiao, Z. Chai, H.-F. Wang, X.-W. Wang, D.-D. Cao, W. Liu, Y.-P. Lu, Y.-Q. Yang and G. Zhao, *Chem. Eur. J.*, 2011, **17**, 10562.
- F. Zhong, X. Han, Y. Wang and Y. Lu, *Chem. Sci.*, 2012, **3**, 1231.
- W. Yao, X. Dou and Y. Lu, *J. Am. Chem. Soc.*, 2015, **137**, 54.
- X. Han, W. Yao, T. Wang, Y. R. Tan, Z. Yan, J. Kwiatkowski and Y. Lu, *Angew. Chem. Int. Ed.*, 2014, **53**, 5643.
- (a) F. Zhong, X. Han, Y. Wang and Y. Lu, *Angew. Chem. Int. Ed.*, 2011, **50**, 7837. (b) F. Zhong, G.-Y. Chen, X. Han, W. Yao and Y. Lu, *Org. Lett.*, 2012, **14**, 3764.
- (a) F. Hu, Y. Wei and M. Shi, *Tetrahedron*, 2000, **68**, 7911. (b) H.-P. Deng, D. Wang, Y. Wei and M. Shi, *Beilstein J. Org. Chem.*, 2012, **8**, 1089.
- X. Zhang, H. Deng, L. Huang, Y. Wei and M. Shi, *Chem. Commun.*, 2012, **48**, 8664.

- 44 For recent reviews on Morita-Baylis-Hillman reaction, see: (a) D. Basavaiah, K. V. Rao and R. J. Reddy, *Chem. Soc. Rev.*, 2007, **36**, 1581. (b) C. Menozzi and P. I. Dalko, Organocatalytic Enantioselective Morita-Baylis-Hillman Reactions. In *Enantioselective Organocatalysis, Reactions and Experimental Procedures*; Dalko, P. I., Ed.; Wiley-VCH: Weinheim, 2007, 151-188.
- 45 J.-J. Gong, K. Yuan, H.-L. Song and X.-Y. Wu, *Tetrahedron*, 2010, **66**, 2439.
- 46 J.-J. Gong, K. Yuan and X.-Y. Wu, *Tetrahedron: Asymmetry*, 2009, **20**, 2117.
- 47 X. Han, Y. Wang, F. Zhong and Y. Lu, *Org. Biomol. Chem.*, 2011, **9**, 6734.
- 48 (a) F. Zhong, Y. Wang, X. Han, K. Huang and Y. Lu, *Org. Lett.*, 2011, **13**, 1310. (b) R. Lee, F. Zhong, B. Zheng, Y. Meng, Y. Lu and K. Huang, *Org. Biomol. Chem.*, 2013, **11**, 4818.
- 49 (a) Y.-L. Shi and M. Shi, *Adv. Synth. Catal.*, 2007, **349**, 2129. (b) M.-J. Qi, T. Ai, M. Shi and G. Li, *Tetrahedron*, 2008, **64**, 1181.
- 50 Y. Gao, Q. Xu and M. Shi, *ACS Catal.*, 2015, **5**, 6608.
- 51 (a) M. M. Rauhut and H. Currier, *US Patent* 307,499,919,630,122, American Cyanamid Co., 1963; *Chem. Abstr.*, 1963, **58**, 11224a. (b) For the review, see: C. E. Aroyan, A. Dermenci and S. J. Miller, *Tetrahedron*, 2009, **65**, 4069.
- 52 J.-J. Gong, T.-Z. Li, K. Pan and X.-Y. Wu, *Chem. Commun.*, 2011, **47**, 1491.
- 53 (a) S. Takizawa, T. M.-N. Nguyen, A. Grossmann, D. Enders and H. Sasai, *Angew. Chem. Int. Ed.*, 2012, **51**, 5423. (b) S. Takizawa, T. M.-N. Nguyen, A. Grossmann, M. Suzuki, D. Enders and H. Sasai, *Tetrahedron*, 2013, **69**, 1202.
- 54 X. Dong, L. Liang, E. Li and Y. Huang, *Angew. Chem. Int. Ed.*, 2015, **54**, 1621.
- 55 W. Zhou, X. Su, M. Tao, C. Zhu, Q. Zhao and J. Zhang, *Angew. Chem. Int. Ed.*, 2015, **54**, 14853.
- 56 Z. Jin, R. Yang, Y. Du, B. Tiwari, R. Ganguly and Y. R. Chi, *Org. Lett.*, 2012, **14**, 3226.
- 57 Z. Shi, P. Yu, T.-P. Loh and G. Zhong, *Angew. Chem. Int. Ed.*, 2012, **51**, 7825.
- 58 (a) X.-N. Zhang, G.-Q. Chen, X. Dong, Y. Wei and M. Shi, *Adv. Synth. Catal.*, 2013, **355**, 3351. (b) X.-N. Zhang, X. Dong, Y. Wei and M. Shi, *Tetrahedron*, 2014, **70**, 2838.
- 59 (a) Y.-Q. Jiang, Y.-L. Shi and M. Shi, *J. Am. Chem. Soc.*, 2008, **130**, 7202. (b) Y.-L. Yang, C.-K. Pei and M. Shi, *Org. Biomol. Chem.*, 2011, **9**, 3349. (c) H.-P. Deng and M. Shi, *Eur. J. Org. Chem.*, 2012, 183. (d) D. Wang, Y.-L. Yang, J.-J. Jiang and M. Shi, *Org. Biomol. Chem.*, 2012, **10**, 7158.
- 60 F. Zhong, J. Luo, G.-Y. Chen, X. Dou and Y. Lu, *J. Am. Chem. Soc.*, 2012, **134**, 10222.
- 61 F. Zhong, X. Dou, X. Han, W. Yao, Q. Zhu, Y. Meng and Y. Lu, *Angew. Chem. Int. Ed.*, 2013, **52**, 943.
- 62 T. Wang, W. Yao, F. Zhong, G.-H. Pang and Y. Lu, *Angew. Chem. Int. Ed.*, 2014, **53**, 2964.
- 63 (a) B. M. Trost, S. Malhotra and W. H. Chan, *J. Am. Chem. Soc.*, 2006, **128**, 4590. (b) T. Matsuura, L. E. Overman and D. J. Poon, *J. Am. Chem. Soc.*, 1998, **120**, 6500. (c) A. Huang, J. J. Kodanko and L. E. Overman, *J. Am. Chem. Soc.*, 2004, **126**, 14043.
- 64 C. Gautier, M. Aletru and P. Bovy, PCT Int. Appl. WO1999062900, 1999.
- 65 J. Chen, Y. Cai and G. Zhao, *Adv. Synth. Catal.*, 2014, **354**, 783.
- 66 H.-Y. Wang, K. Zhang, C.-W. Zheng, Z. Chai, D.-D. Cao, J.-X. Zhang and G. Zhao, *Angew. Chem. Int. Ed.*, 2015, **54**, 1775.
- 67 Y.-P. Lou, C.-W. Zheng, R.-M. Pan, Q.-W. Jin, G. Zhao and Z. Li, *Org. Lett.*, 2015, **17**, 688.
- 68 Y. Li, X. Su, W. Zhou, W. Li and J. Zhang, *Chem. Eur. J.*, 2015, **21**, 4224.
- 69 D. Cao, Z. Chai, J. Zhang, Z. Ye, H. Xiao, H. Wang, J. Chen, X. Wu and G. Zhao, *Chem. Commun.*, 2013, **49**, 5972.
- 70 X. Wu, Q. Liu, Y. Liu, Q. Wang, Y. Zhang, J. Chen, W. Cao and G. Zhao, *Adv. Synth. Catal.*, 2013, **355**, 2701.
- 71 P. J. Cuiry and C. P. Saunders, *Adv. Synth. Catal.*, 2004, **346**, 497.
- 72 (a) R. M. Kellogg and J. H. Griffin, *J. Org. Chem.*, 1985, **50**, 3261. (b) R. M. Kellogg and B. K. Vriesema, *Tetrahedron Lett.*, 1986, **27**, 2049. (c) G. A. Cross and R. M. Kellogg, *J. Chem. Soc., Chem. Commun.*, 1987, 1746. (d) G. A. Cross, B. K. Vriesema, G. Boven and R. M. Kellogg, *J. Organomet. Chem.*, 1989, **370**, 357.
- 73 J. W. Faller and K. J. Chase, *Organometallics*, 1994, **13**, 989.
- 74 (a) K. Hiroi, Y. Suzuki and I. Abe, *Tetrahedron: Asymmetry*, 1999, **10**, 1173. (b) J. Uenishi and M. Hamada, *Tetrahedron: Asymmetry*, 2001, **12**, 2999.
- 75 (a) A. Saitoh, K. Achiwa and T. Morimoto, *Tetrahedron: Asymmetry*, 1998, **9**, 741. (b) A. Saitoh, K. Achiwa, K. Tanaka and T. Morimoto, *J. Org. Chem.*, 2000, **65**, 4227.
- 76 (a) S. R. Gilbertson, S. E. Collibee and A. Agarkov, *J. Am. Chem. Soc.*, 2000, **122**, 6522. (b) S. J. Greenfield, A. Agarkov and S. R. Gilbertson, *Org. Lett.*, 2003, **5**, 3069.
- 77 T. Morimoto, Y. Yamaguchi, M. Suzuki and A. Saitoh, *Tetrahedron Lett.*, 2000, **41**, 10025.
- 78 K. Kawamura, H. Fukuzawa and M. Hayashi, *Org. Lett.*, 2008, **10**, 3509.