

NJC

Accepted Manuscript



This is an *Accepted Manuscript*, which has been through the Royal Society of Chemistry peer review process and has been accepted for publication.

Accepted Manuscripts are published online shortly after acceptance, before technical editing, formatting and proof reading. Using this free service, authors can make their results available to the community, in citable form, before we publish the edited article. We will replace this *Accepted Manuscript* with the edited and formatted *Advance Article* as soon as it is available.

You can find more information about *Accepted Manuscripts* in the [Information for Authors](#).

Please note that technical editing may introduce minor changes to the text and/or graphics, which may alter content. The journal's standard [Terms & Conditions](#) and the [Ethical guidelines](#) still apply. In no event shall the Royal Society of Chemistry be held responsible for any errors or omissions in this *Accepted Manuscript* or any consequences arising from the use of any information it contains.

Pd^{II}-mediated Integration of Isocyanides and Azide Ion Might Proceed via Formal 1,3-Dipolar Cycloaddition between RNCs Ligands and Uncomplexed Azide

Received 00th January 20xx,
Accepted 00th January 20xx

DOI: 10.1039/x0xx00000x

www.rsc.org/

Mikhail A. Kinzhalov,^a Alexander S. Novikov,^a Konstantin V. Luzyanin,^{a,b} Matti Haukka,^c Armando J. L. Pombeiro,^d and Vadim Yu. Kukushkin^{*a}

Reaction between equimolar amounts of *trans*-[PdCl(PPh₃)₂(CNR)][BF₄] (R = *t*-Bu **1**, Xyl **2**) and diisopropylammonium azide **3** gives the tetrazolate *trans*-[PdCl(PPh₃)₂(CN₄*t*-Bu)] (67%, **4**) or *trans*-[PdCl(PPh₃)₂(CN₄Xyl)] (72%, **5**). Complexes **4** and **5** were characterized by elemental analyses (C, H, N), HRESI⁺-MS, ¹H and ¹³C{¹H} NMR spectroscopies. In addition, the structure of **4** was elucidated by a single-crystal X-ray diffraction. DFT calculations showed that the mechanism for the formal cycloaddition (CA) of N₃⁻ to *trans*-[PdCl(PPh₃)₂(CNMe)]⁺ is stepwise. The process is both kinetically and thermodynamically favorable and occurs via the formation of the acyclic NNNCN-intermediate. The second step of the formal CA, *i.e.* cyclization, is the rate limiting. Despite the fact that the substitution of CNMe by N₃⁻ ligand is slightly thermodynamically favorable, we were unable to find paths on the potential energy surface for hypothetical CA between uncomplexed isocyanide and palladium-bound azide. Thus, we believe that the experimentally observed palladium tetrazolate complexes are, in fact, generated from the negatively charged uncomplexed azide and the positively charged metal-bound isocyanide species, and this reaction path is favorable from the viewpoint of Coulomb attraction.

Introduction

Being one of the most studied ligands in contemporary organometallic chemistry and catalysis, *N*-heterocyclic carbenes (NHCs) continue to attract a lot of attention due to their valuable characteristics, *e.g.*, high chemical and thermal stability, low toxicity, and variability of donor and steric properties.¹ Preparation of metal complexes with NHCs ligands can be achieved via either direct coordination of pre-prepared (or generated *in situ*) free NHCs to metal center,¹ or through diverse cyclizations of metal-bound isocyanides and this subject was repeatedly reviewed including recent surveys by some of us.²

Firstly (**Scheme 1, route A**), cyclic carbenes are prepared *via* two-step cascade synthesis that includes a nucleophilic attack of an amino or alcohol function of X(H)CH₂CH₂Br (XH = OH, NH₂) on a coordinated isocyanide followed by ring closure.^{2b,2d}

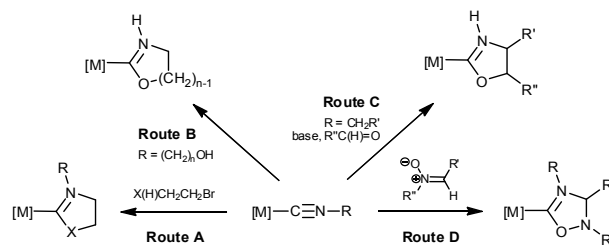

Scheme 1. Conversion of ligated isocyanides into *N*-heterocyclic carbene complexes.

Secondly (**route B**), metal-NHCs are generated *via* a spontaneous or base-promoted intramolecular cyclization of complexes featuring functionalized isocyanides, *e.g.* M–C≡N–(CH₂)_n–OH.^{2d} Thirdly (**route C**), isocyanides bearing acidic C–H bonds in the α -position to the C≡N group, *e.g.* M–C≡N–CH₂EWG (where EWG stands for an electron withdrawing moiety), being ionized with a base, react with polar double bonds (*e.g.* with RC(H)=O as a 1,3-dipolarophile) furnishing heterocycles.³

Finally, complexes with NHC ligands can be generated *via* a metal-mediated 1,3-dipolar cycloaddition (CA) of some dipoles to isocyanides (**route D**). Examples of the latter route are so far limited to CA of nitrile imines [accomplishing the carbene

^a St. Petersburg State University, 7-9, Universitetskaya nab., St. Petersburg, 199034 Russia

^b Department of Chemistry, University of Liverpool, Crown Street, Liverpool L69 7ZD United Kingdom.

^c Department of Chemistry, University of Jyväskylä, P.O. Box 35, FI-40014, Finland.

^d Centro de Química Estrutural, Instituto Superior Técnico, Universidade de Lisboa, Av. Rovisco Pais, 1049-001 Lisbon, Portugal

Electronic Supplementary Information (ESI) available: [Crystal data, calculated total energies, enthalpies, Gibbs free energies and entropies in gas phase and CH₂Cl₂ solution, calculated total activation and reaction energies, enthalpies and Gibbs free energies of activation and reaction for the gas phase and CH₂Cl₂ solution, cartesian atomic coordinates of the calculated equilibrium structures]. See DOI: 10.1039/x0xx00000x

$\{C(NR''N=C^{\sigma}R')=N^{\delta}R(C^{\sigma}-N^{\delta})\}$,⁴ nitrile ylides⁴ [yielding the $\{C(CHR''N=C^{\sigma}R')=N^{\delta}R(C^{\sigma}-N^{\delta})\}$ functionality] and, as we previously observed, acyclic and cyclic nitrones [giving the $\{C(CHR''N=C^{\sigma}R')=N^{\delta}R(C^{\sigma}-N^{\delta})\}$ moiety] to coordinated RNCs,⁵ and the metal-mediated interplay between RNC and azide leading to complexes with C-bound tetrazolate ligands, *i.e.* $\{C(NNN^{\sigma})=N^{\delta}R(N^{\sigma}-N^{\delta})\}$.^{2d, 6} The mechanisms of these processes can be concerted or stepwise; in the latter case the formal CA is completely asynchronous and occurs via formation of an acyclic intermediate followed by ring-closure.

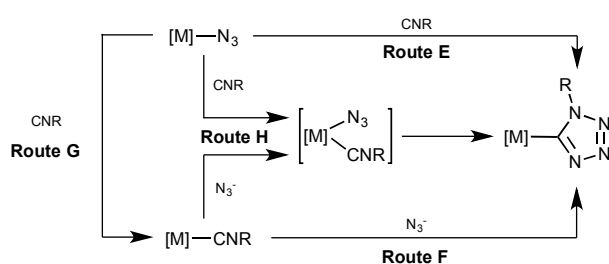

Scheme 2. Metal-mediated generation of tetrazolate species.

Inspection of literature relevant to metal-involving CA between azides and isocyanides⁶⁻⁷ indicated that up to now a substantial number of reports was devoted to reactions between *uncomplexed isocyanides* and metal-bound azides at palladium(II),⁸ platinum(II),^{8a, 8d-f, 8j, 9} gold(I),¹⁰ gold(III),^{8c, 11} and nickel(II)^{8d, 8f, 12} centers (**Scheme 2, route E**). In the vast majority of cases,^{8b-e, 8h-j, 9a, 10, 12} it is believed that CA proceeds through the attack of the free isocyanide on a complexed azide, albeit no mechanistic studies were undertaken. In one work,¹³ it is suggested that the reaction starts from the joint coordination of azide and isocyanide to a metal center giving an intermediate pentacoordinated species that is subsequently transformed into C-tetrazolates via an intramolecular CA (**route H**). However, the latter mechanism was neither supported experimentally, nor theoretically.

An alternative approach to generation of tetrazolate complexes via CA is based on the use of *metal-bound isocyanides* and uncomplexed azide ion. Until now this approach was represented by a single study where CA was conducted at a platinum(II) center (**route F**) when the isocyanide complexes $[Pt(PPh_3)_2(CNMe)_2][BF_4]_2$ and $[Pt(diphos)(CNMe)_2][PF_6]_2$ were treated with one and two equivalents NaN_3 in water, correspondingly, and CA led to the C-tetrazolate species $[Pt(PPh_3)_2(CNMe)(CN_4Me)][BF_4]$ (78%) and $[Pt(diphos)(CN_4Me)_2]$ (90%), respectively.¹³ As believed, this CA proceeds by attack of azide ion on the square-planar complex to give an intermediate five-coordinate species (**route H**), which then undergoes a facile cyclization accomplishing the tetrazolate complexes.

In principle, the mechanism of metal-mediated CA between isocyanides and azides could involve complexed azide as dipole and uncomplexed CNR as dipolarophile (Sustman III type of CA,¹⁴ **route E**), metal-bound isocyanide as dipolarophile and free azide as dipole (Sustman I type of CA,¹⁴ **route F**), and joint coordination of the reactants furnishing C-tetrazolate species (**route H**). Alternatively the reaction between metal-azides and isocyanides may proceed via the azide substitution step followed by CA (**routes G-F**).

In pursuit of our previous studies on CA to metal-bound (in particular to Pd^{II}-ligated) nitriles (see our reviews,¹⁵ recent experimental,¹⁶ and also theoretical¹⁷ works) and isocyanides (see reviews,^{2d} experimental,^{5, 18} and theoretical¹⁹ works and general interest in the metal-involving chemistry of azides (see recent review by Fehlhammer and Beck⁶) we decided to verify the most probable route for generation of palladium(II)-tetrazolates from RNCs and N_3^- . To reach this goal we, first of all, decided to find experimental evidences that the palladium-tetrazolates could be obtained not only by the known reaction between (azide)Pd^{II} species and uncomplexed RNCs,⁸ but also via yet unreported integration of some (RNC)Pd^{II} precursors and uncomplexed azide. These experimental examples should form the solid background for theoretical works – which comprise the main goal of this study – directed toward verification of a plausible reaction mechanism that may proceed via routes **E, F, H, or G-F (Scheme 2)**, establishment of driving forces of the generation of (tetrazolate)Pd^{II} complexes and identification of key intermediates of this palladium(II)-mediated integration.

Results and Discussion

Cycloaddition of Azide to Pd^{II}-bound Isocyanides. In order to verify the reactivity of palladium-isocyanide species toward N_3^- , we attempted to carry out CA of diisopropylammonium azide **3** to the isocyanide ligands in *trans*- $[PdCl(PPh_3)_2(CNR)][BF_4]$ ²⁰ (R = *t*-Bu **1**, Xyl **2**). Reaction between equimolar amounts of complex **1** (or **2**) and **3** proceeds in CH_2Cl_2 at room temperature (RT) for *ca.* 1 d giving the tetrazolate *trans*- $[PdCl(PPh_3)_2(CN_4t-Bu)]$ (**4**) or *trans*- $[PdCl(PPh_3)_2(CN_4Xyl)]$ (**5**) (**Scheme 3**) species. After evaporation of the solvent, these complexes were washed with MeOH/Et₂O mixture (1:1, v/v) and purified by recrystallization from a CH_2Cl_2 /Et₂O mixture giving **4** (67%) and **5** (72%) in good isolated yields.

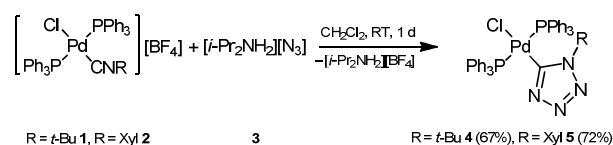

Scheme 3. Reaction between *trans*- $[PdCl(PPh_3)_2(CNR)][BF_4]$ (R = *t*-Bu **1**, Xyl **2**) and diisopropylammonium azide (**3**).

Complexes **4** and **5** were obtained as pale yellow solids and characterized by elemental analyses (C, H, N), HRESI⁺-MS, ¹H and ¹³C{¹H} NMR spectroscopies. In addition, the structure of **4** was elucidated by a single-crystal X-ray diffraction. Complexes **4** and **5** gave satisfactory C, H, and N elemental analyses, which are consistent with the proposed formulae. The ESI⁺ mass spectra demonstrated a fragmentation pattern corresponding to the loss of Cl from the molecular ion along with the characteristic isotopic distribution. CA of **3** to **1** or **2** is accompanied by a pronounced downfield $\delta^{13}C$ shift of the isocyanide quaternary C atom to the range common for tetrazolate ring Pd–CN₄R (δ_C 150–165 ppm).^{8a-f, 8k, 9a} In **4** and **5**, the CN₄R ¹³C signals were found to resonate at δ_C 151.5 and 161.9 ppm, respectively; that is *ca.* 45 ppm downfield shifted vs. **1** and **2** (*e.g.* 115 ppm for C≡N in **1**).

In **4** (Figure 1), the PPh₃ are mutually *trans* (P1–Pd1–P2 167.93(2)°) and a slightly distorted square-planar environment around the metal center is completed with one tetrazolate and one chloride ligand. Bond angles around Pd as vertex are all within 3.0° of the values for an ideal square-plane. The Pd–C distance [Pd1–C1 1.989(2) Å] is comparable to those reported for the related palladium tetrazolate complex *trans*-[Pd(PMe₃)₂(C_N₄Xyl)(N=C=NR)] (2.006(5) Å).^{8e}

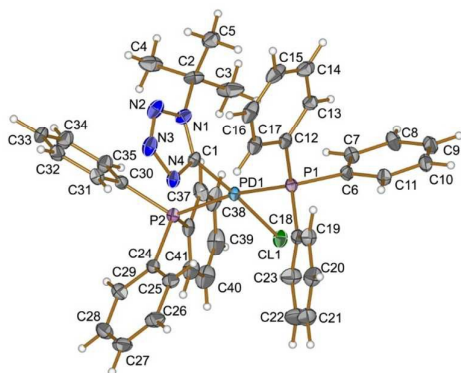
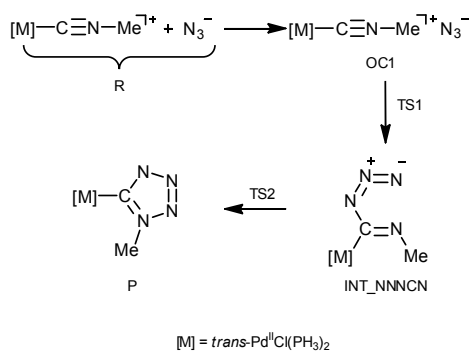

Figure 1. View of **4** with the atomic numbering schemes. Thermal ellipsoids are drawn at the 50% probability level. Hydrogen labels are omitted for simplicity.

Our little synthetic experiment proved that the integration between RNC and N₃⁻ species giving C-tetrazolate complexes might proceed via route F (Scheme 2) not only at platinum(II),¹³ but also at palladium(II) centers. These data form the background for further theoretical study aimed toward verification of plausible mechanism of this reaction and results of the study are disclosed in the next section.

Theoretical Study. In order to shed light on the mechanism of the Pd^{II}-mediated azide–isocyanide integration, a quantum chemical DFT study of this process in a model system was undertaken (CPCM-B3LYP/6-311+G(d,p)//gas-B3LYP/6-31G(d)). The route F was found the most preferred out of all possible reaction paths shown in Scheme 2. Discussion about this and other plausible reaction channels is given below.



Scheme 4. Mechanism of Pd^{II}-mediated azide–isocyanide integration.

The mechanism of the formation of (tetrazolate)Pd^{II} complexes via formal CA of N₃⁻ to *trans*-[PdCl(PH₃)₂(CNMe)]⁺ complexes (Scheme 2, route F) was found to be stepwise (Scheme 4).

The process is initiated by the formation of the orientation complex *trans*-[PdCl(PH₃)₂(CNMe)]⁺•N₃⁻ (OC1), and two transition states (TSs) were located. The first one (TS1) corresponds to the formation of the C–N bond giving the acyclic NNNCN-intermediate (INT_NNNCN) and the second one (TS2) is associated with the ring closure forming the C-tetrazolate complex *trans*-[PdCl(PH₃)₂(C_N₄Me)] (P). The second step is the rate limiting (Figure 2, Table S3). Noteworthy that we were unable to locate on the potential energy surface any TSs for the concerted pathway or other acyclic NNNCN-intermediates. Based upon our quantum chemical calculations one can state that the formation of the C-tetrazolate palladium complexes *trans*-[PdCl(PH₃)₂(C_N₄Me)] from coordinated isocyanides and free azides is quite favorable from both kinetic and thermodynamic viewpoints.

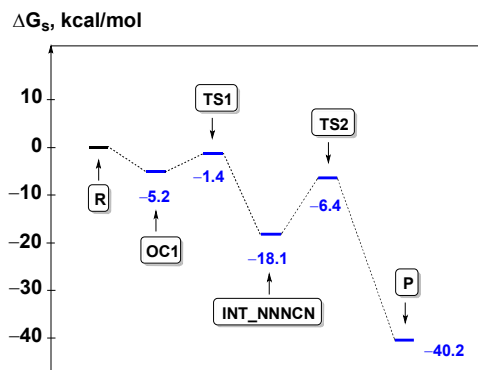

Figure 2. Energy profile of R → P transformation for Pd^{II}-mediated azide–isocyanide integration.

We estimated the relative stability of two possible types of the orientation complexes in the model reaction system, *viz.* *trans*-[PdCl(PH₃)₂(CNMe)]⁺•N₃⁻ (OC1) versus *trans*-[PdCl(PH₃)₂(N₃)]•CNMe (OC2) and found that the OC1 → OC2 transformation (Scheme 2, inverse route G) is just slightly thermodynamically favorable (ΔG_s = -1.0 kcal/mol). Taking this into account, the hypothetical reactions between uncomplexed isocyanide and metal-bound azide (Scheme 2, route E) were also inspected (Table S3) and the following conclusions can be drawn. Firstly, we were unable to locate any TSs and intermediates for the CNMe + *trans*-[PdCl(PH₃)₂(N₃)] → *trans*-[PdCl(PH₃)₂(C_N₄Me)] processes. Secondly, we found two TSs (TS3 and TS4) for the CNMe + *trans*-[PdCl(PH₃)₂(N₃)] → N₂ + *trans*-[PdCl(PH₃)₂(N=C=NMe)] (ΔG_s[‡] = 36.2 kcal/mol, ΔG_s = -62.2 kcal/mol) and CNMe + *trans*-[PdCl(PH₃)₂(N₃)] → *trans*-[PdCl(PH₃)₂(N₂)]⁺ + N=C=NMe⁻ (ΔG_s[‡] = 39.0 kcal/mol, ΔG_s = -9.0 kcal/mol) concerted transformations. Obviously that although being thermodynamically favorable these paths are not realized at room temperature due to too high activation barriers.

In order to get experimental evidences supporting generation of (isocyanide)Pd complexes from the corresponding azide precursors, we additionally conducted IR monitoring of two ligand substitution reactions, *viz.* between [PdCl(N₃)(PPh₃)₂] and CNXyl on the one

hand, and between $[\text{PdCl}(\text{PPh}_3)_2\text{CNXyl}][\text{BF}_4]$ and N_3^- on the other hand. In the former case, immediately after mixing the two reactants we detected the appearance of a new band at 2204 cm^{-1} from coordinated isocyanide (in $[\text{PdCl}(\text{PPh}_3)_2\text{CNXyl}][\text{BF}_4]$ $\nu(\text{CN})$ 2204 cm^{-1}), whereas in the latter case, only after approximately 20 min we observed the emergence of weak absorbance from the uncomplexed isocyanide (2099 cm^{-1}). These observations suggest that for the studied system the complexation equilibrium is shifter toward the isocyanide complex and, in turn, the isocyanide is a better ligand than azide. All these give an additional (but not the final) evidences that the isocyanide–azide integration might proceed via cycloaddition of N_3^- to CNXyl ligand.

In order to verify the hypothesis¹³ on formation of intermediates bearing both azide and isocyanide species bound to the metal center (**Scheme 2, route H**), we undertook an extensive search of appropriate minima on the potential energy surface with various mutual positions of these ligands in the model starting structures. However, we were unable to locate any pentacoordinated intermediates, and all attempts to fix them led to the migration of one ligand from the coordination sphere of the metal center during the geometry optimization procedure or to the collapse of the whole structure of the palladium model complex. Hence, **route H** can be excluded from consideration.

The metal-free reaction $\text{N}_3^- + \text{CNMe} \rightarrow \text{CN}_4\text{Me}^-$ is thermodynamically unfavorable ($\Delta G_s = 4.7\text{ kcal/mol}$) and we were unable to locate appropriate TSs and intermediates for both concerted and stepwise paths. However, we found TS (**TS_{metal-free}**) for the $\text{N}_3^- + \text{CNMe} \rightarrow \text{N}_2 + \text{N}=\text{C}=\text{NMe}^-$ concerted transformation and it is highly thermodynamically favorable ($\Delta G_s = -55.5\text{ kcal/mol}$), but kinetically hindered ($\Delta G_s^\ddagger = 35.2\text{ kcal/mol}$).

We checked the tendency toward decomposition of *trans*- $[\text{PdCl}(\text{PH}_3)_2(\text{CN}_4\text{Me})]$ complexes and uncomplexed tetrazolate CN_4Me^- via the paths *trans*- $[\text{PdCl}(\text{PH}_3)_2(\text{CN}_4\text{Me})] \rightarrow \text{N}_2 + \text{trans}-[\text{PdCl}(\text{PH}_3)_2(\text{N}=\text{C}=\text{NMe})]$ (by **TS5**) and $\text{CN}_4\text{Me}^- \rightarrow \text{N}_2 + \text{N}=\text{C}=\text{NMe}^-$ (by **TS5_{metal-free}**), respectively (**Table S3**). One can conclude that the tetrazolate CN_4Me^- species are very susceptible to decomposition ($\Delta G_s^\ddagger = 10.8\text{ kcal/mol}$, $\Delta G_s = -60.2\text{ kcal/mol}$), but the palladium center is excellent stabilizer for such anionic species ($\Delta G_s^\ddagger = 36.5\text{ kcal/mol}$, $\Delta G_s = -35.2\text{ kcal/mol}$).

Finally, we compared the thermodynamic stability of the tetrazolate complexes *trans*- $[\text{PdCl}(\text{PH}_3)_2(\text{CN}_4\text{Me})]$, where the CN_4Me^- ligand is coordinated to the metal by different alternative sites (**Figure 3**). The stability series is the following: *trans*- $[\text{PdCl}(\text{PH}_3)_2(\text{CN}_4\text{Me})]$ (0 kcal/mol in terms of Gibbs free energy in solution, internal standard) > **A** (24.4 kcal/mol) > **B** (33.9 kcal/mol) > **C** (42.2 kcal/mol).

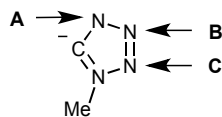

Figure 3. Alternative binding sites of the tetrazolate ligand.

Conclusions

The results of this work could be considered from the following perspectives. Firstly, in pursuit of our studies on cycloaddition to metal-bound RNCs,^{5, 18-19} we observed that the metal-mediated

reaction between equimolar amounts of the isocyanide ligand in *trans*- $[\text{PdCl}(\text{PPh}_3)_2(\text{CNR})][\text{BF}_4]$ ($\text{R} = t\text{-Bu, Xyl}$) and diisopropylammonium azide proceeds in CH_2Cl_2 at room temperature furnishing the *C*-tetrazolate complexes *trans*- $[\text{PdCl}(\text{PPh}_3)_2(\text{CN}_4\text{R})]$ (ca. 70%). Generation of *C*-tetrazolato ligands from metal-bound RNCs and uncomplexed N_3^- was previously observed only at a platinum(II) center, whereas many other synthetic routes to *C*-tetrazolato metal complexes involve reaction between metal-bound azide and uncomplexed isocyanides.

Secondly, based upon quantum chemical calculations we established that the mechanism for the formal cycloaddition of N_3^- to *trans*- $[\text{PdCl}(\text{PH}_3)_2(\text{CNMe})]^\ddagger$ is stepwise. The process is both kinetically and thermodynamically favorable and occurs via the formation of the acyclic NNCCN-intermediate. The second step of formal cycloaddition, *i.e.* cyclization, is the rate limiting. Despite the fact that the substitution of CNMe by N_3^- ligand is slightly thermodynamically favorable, we were unable to find the paths on the potential energy surface for the hypothetical cycloaddition between uncomplexed isocyanide and palladium-bound azide. Thus, we believe that the experimentally observed palladium tetrazolate complexes is, in fact, generated from the negatively charged uncomplexed azide and positively charged metal-bound isocyanide species, and this reaction path is favorable from the viewpoint of Coulomb attraction. However, the alternative mechanism that involves complexed azide and uncomplexed RNCs (**Scheme 2, route E**) can be feasible at other metal centers and the previously obtained synthetic results collaterally confirm this assumption. Previously published data⁸ on the integration between azide complexes and isocyanides may potentially require reconsideration to address the possibility that the interaction proceeds through an alternative mechanism involving the substitution of an azide ligand with isocyanide followed by cycloaddition.

Experimental Section

Materials and Instrumentation. Solvents and reagents were obtained from commercial sources and used as received, apart from chloroform, which was purified by the conventional distillation over calcium chloride. Complexes **1–2** were prepared by the known procedures.²⁰ C, H, and N elemental analyses were carried out on a Euro EA 3028HT CHNS/O analyzer. Mass spectra were obtained on a Bruker micrOTOF spectrometer equipped with electrospray ionization (ESI) source and MeCN was used as the solvents. The instrument was operated both at positive and negative ion modes using m/z range of 50–3000. The capillary voltage of the ion source was set at -4500 V (ESI⁺) or 3500 V (ESI⁻) and the capillary exit at $\pm(70\text{--}150)\text{ V}$. The nebulizer gas pressure was 0.4 bar and drying gas flow 4.0 L/min. The most intensive peak in the isotopic pattern is reported. Infrared spectra ($4000\text{--}400\text{ cm}^{-1}$) were recorded on a Shimadzu FTIR 8400S instrument in CHCl_3 solutions. 1D (¹H, ¹³C{¹H}, DEPT) NMR spectra were acquired on a Bruker Avance 400 spectrometer at ambient temperature.

Synthetic Work

Cycloaddition of 3 to $[\text{PdCl}(\text{PPh}_3)_2(\text{CNR})][\text{BF}_4]$. A solution of **3** (22 mg, 0.15 mmol) in CH_2Cl_2 (3 mL) was added to a solution of **1** or **2** (0.15 mmol) in CH_2Cl_2 (4 mL) and the reaction mixture was stirred at RT. After 1d, the solvent was evaporated at RT, the residue was

washed with a Et₂O (6 mL) and MeOH (1 mL) mixture. The products were slowly recrystallized from a CH₂Cl₂:Et₂O (1:1, v/v) mixture at RT.

4 (80 mg, 67%). Anal. Calcd. for C₄₁H₃₉N₄ClP₂Pd: C, 61.21; H, 4.97; N, 7.08. Found: C, 61.44; H, 4.98; N, 7.12. HRESI⁺-MS, *m/z*: calcd. for C₄₁H₃₉N₄P₂Pd⁺ 755.1679, found 755.1652 [M - Cl]⁺. ¹H NMR (400.13 MHz, CDCl₃, δ): 1.21 (s, 9H, CH₃), 7.32 (t, ³J_{H,H} = 7.3 Hz, 12H), 7.40 (t, ³J_{H,H} = 7.3 Hz, 6H), 7.47 (q, ³J_{H,H} = 6.2 Hz, 12H). ¹³C{¹H} NMR (100.61 MHz, CDCl₃, δ): 30.2 (CH₃), 58.0 (C(CH₃)₃), 128.4 (t, *J*_{C,P} = 5 Hz, CH, C from PPh₃), 129.8 (t, *J*_{C,P} = 24 Hz, C, C from PPh₃), 130.6 (CH, C from PPh₃), 134.5 (t, *J*_{C,P} = 6 Hz, CH, C from PPh₃), 151.5 (C, C from the tetrazolate ring).

5 (88 mg, 72%). Anal. Calcd. for C₄₅H₃₉N₄ClP₂Pd: C, 64.37; H, 4.68; N, 6.67. Found: C, 63.42; H, 4.64; N, 6.70. HRESI⁺-MS, *m/z*: calcd. for C₄₃H₃₉N₄P₂Pd⁺ 803.1679, found 803.1661 [M - Cl]⁺. ¹H NMR (400.13 MHz, CDCl₃, δ): 2.22 (s, 6H, CH₃), 6.96 (d, ³J_{H,H} = 7.3 Hz, 12H), 7.12–7.72 (m, 32H). ¹³C{¹H} NMR (100.61 MHz, CDCl₃, δ): 21.0 (CH₃), 128.0–136.2 (C from Xyl and PPh₃), 161.9 (C, C from the tetrazolate ring).

X-ray Structure Determination

The crystal of **4** was immersed in cryo-oil, mounted in a MiTeGen loop, and measured at a temperature of 123 K. The X-ray diffraction data was collected on a Bruker Axs KappaCCD diffractometer using Mo K α radiation (λ = 0.710 73 Å). The Denzo-Scalepack²¹ program package was used for cell refinement and data reduction. The structure was solved by charge flipping method using Superflip²² program with the Olex2²³ graphical user interface. A semi-empirical absorption correction (SADABS)²⁴ was applied to the data. Structural refinement was carried out using SHELXL-97.²⁵ Hydrogen atoms were positioned geometrically and constrained to ride on their parent atoms, with C–H = 0.95–1.00 and U_{iso} = 1.2–1.5 U_{eq}(parent atom). The crystallographic details are summarized in Table S1 (see ESI). CCDC-1414621 contain the supplementary crystallographic data for this paper. These data can be obtained free of charge from The Cambridge Crystallographic Data Centre via www.ccdc.cam.ac.uk/data_request/cif.

Computational Details

The full geometry optimization of all structures and transition states was carried out at the DFT/HF hybrid level of theory using Becke's three-parameter hybrid exchange functional in combination with the gradient-corrected correlation functional of Lee, Yang and Parr (B3LYP)²⁶ with the help of the Gaussian-09²⁷ program package. No symmetry operations have been applied. The geometry optimization was carried out using a quasi-relativistic Stuttgart pseudopotential that described 28 core electrons and the appropriate contracted basis sets²⁸ for the palladium atoms and the 6-31G(d) basis set for other atoms. Single-point calculations were performed on the basis of the equilibrium geometries found by using the 6-311+G(d,p) basis set for nonmetal atoms. As was shown previously,^{17a, b, 17d-f} this approach is sufficiently accurate for the description of CAs to the C≡N triple bond providing results close to those obtained by such methods as MP2, MP4, CCSD(T), CBS-Q, and G3B3.

The Hessian matrix was calculated analytically for the optimized structures in order to prove the location of correct minima (no imaginary frequencies) or saddle points (only one imaginary frequency), and to estimate the thermodynamic parameters, the latter being calculated at 25 °C. The nature of all transition states was investigated by the analysis of vectors associated with the

imaginary frequency and by the calculations of the intrinsic reaction coordinates (IRC) using the Gonzalez–Schlegel method.²⁹

The total energies corrected for solvent effects (*E*_s) were estimated at the single-point calculations on the basis of gas-phase geometries at the CPCM-B3LYP/6-311+G(d,p)//gas-B3LYP/6-31G(d) level of theory using the polarizable continuum model in the CPCM version^{30,31} with CH₂Cl₂ as solvent. The UAKS model was applied for the molecular cavity and dispersion, cavitation, and repulsion terms were taken into account. The entropic term in CH₂Cl₂ solution (*S*_s) was calculated according to the procedure described by Wertz³² and Cooper and Ziegler³³ (see eqs. 1–4), as well as enthalpies and Gibbs free energies in solution (*H*_s and *G*_s) using the expressions 5 and 6 (all equations are provided in Supplementary information)

Acknowledgements

Theoretical part of this work was conducted within Russian Science Foundation project (14-43-00017), whereas the synthetic part was done under Russian Foundation for Basic Research project (14-03-31204 mol_a) and the authors are grateful to both foundations for support of their studies. MAK and ASN acknowledge the financial support from Saint Petersburg State University (travel grant 12.42.1262.2014 and postdoctoral fellowship 12.50.1190.2014, correspondingly). Physicochemical studies were performed at the Center for Magnetic Resonance and Center for Chemical Analysis and Materials Research (both belong to Saint Petersburg State University).

References

1. a) F. E. Hahn and M. C. Jahnke, *Angew. Chem. Int. Ed.*, 2008, **47**, 3122–3172; b) W. A. Herrmann, *Angew. Chem. Int. Ed.*, 2002, **41**, 1290–1309; c) S. T. Liddle, I. S. Edworthy and P. L. Arnold, *Chem. Soc. Rev.*, 2007, **36**, 1732–1744; d) V. Cesar, S. Bellemin-Laponnaz and L. H. Gade, *Chem. Soc. Rev.*, 2004, **33**, 619–636; e) P. Arnold and S. Pearson, *Coord. Chem. Rev.*, 2007, **251**, 596–609.
2. a) R. A. Michelin, A. J. L. Pombeiro and M. F. C. Guedes da Silva, *Coord. Chem. Rev.*, 2001, **218**, 75–112; b) R. S. Chay and K. V. Luzyanin, *Inorg. Chim. Acta*, 2012, **380**, 322–327; c) V. P. Boyarskiy, K. V. Luzyanin and V. Y. Kukushkin, *Coord. Chem. Rev.*, 2012, **256**, 2029–2056; d) V. P. Boyarskiy, N. A. Bokach, K. V. Luzyanin and V. Y. Kukushkin, *Chem. Rev.*, 2015, **115**, 2698–2779.
3. a) W. P. Fehlhammer, K. Bartel and W. Petri, *J. Organomet. Chem.*, 1975, **87**, C34–C36; b) K. R. Grundy and W. R. Roper, *J. Organomet. Chem.*, 1975, **91**, C61–C64.
4. Y. Fuchita, K. Hidaka, S. Morinaga and K. Hiraki, *Bull. Chem. Soc. Jpn.*, 1981, **54**, 800.
5. K. V. Luzyanin, A. G. Tskhovrebov, M. F. C. Guedes da Silva, M. Haukka, A. J. L. Pombeiro and V. Y. Kukushkin, *Chem.-A Eur. J.*, 2009, **15**, 5969–5978.
6. W. P. Fehlhammer and W. Beck, *Z. Anorg. Allg. Chem.*, 2015, **641**, 1599–1678.
7. a) H.-W. Frühauf, *Chem. Rev.*, 1997, **97**, 523–596; b) W. Beck, K. Burger and W. P. Fehlhammer, *Chem. Ber.*, 1971, **104**, 1816–1825.

8. a) Y.-J. Kim, D.-H. Kim, J.-Y. Lee and S.-W. Lee, *J. Organomet. Chem.*, 1997, **538**, 189–197; b) Y.-J. Kim, Y.-S. Kwak and S.-W. Lee, *J. Organomet. Chem.*, 2000, **603**, 152–160; c) M. Wehlan, R. Thiel, J. Fuchs, W. Beck and W. P. Felhammer, *J. Organomet. Chem.*, 2000, **613**, 159; d) Y.-J. Kim, Y.-S. Joo, J.-T. Han, W. S. Han and S.-W. Lee, *Dalton Trans.*, 2002, 3611; e) Y.-J. Kim, Y.-S. Kwak, Y.-S. Joo and S.-W. Lee, *Dalton Trans.*, 2002, 144–151; f) Y.-J. Kim, J.-T. Han, S. Kang, W. S. Han and S. W. Lee, *Dalton Trans.*, 2003, **17**, 3357–3364; g) W. S. Han, H. K. Lee, Y.-J. Kim and S. W. Lee, *Acta Crystallogr.*, 2004, **E60**, m1813–m1814; h) Y.-J. Kim, X. Chang, J.-T. Han, M. S. Lim and S. W. Lee, *Dalton Trans.*, 2004, **21**, 3699–3708; i) Y.-J. Kim, S.-H. Lee, S.-H. Lee, S. I. Jeon, M. S. Lim and S. W. Lee, *Inorg. Chim. Acta*, 2005, **358**, 650–658; j) H. S. Huh, Y. K. Lee and S. W. Lee, *J. Mol. Struct.*, 2006, **789**, 209; k) Y.-J. Kim, K.-E. Lee, H.-T. Jeon, H. S. Huh and S. W. Lee, *Inorg. Chim. Acta*, 2008, **361**, 2159–2165.
9. a) X. Chang, K.-E. Lee, Y.-J. Kim and S. W. Lee, *Inorg. Chim. Acta*, 2006, **359**, 4436–4440; b) W. S. Kim, Y.-J. Kim and S. W. Lee, *Bull. Korean Chem. Soc.*, 2002, **23**, 1177–1180.
10. W. F. Gabrielli, S. D. Nogai, J. M. McKenzie, S. Cronje and H. G. Raubenheimer, *New J. Chem.*, 2009, **33**, 2208–2218.
11. a) W. Beck and W. P. Fehlhammer, *Angew. Chem. Int. Ed.*, 1967, **6**, 169–170; b) W. P. Fehlhammer and L. F. Dahl, *J. Am. Chem. Soc.*, 1972, **94**, 3370–3377.
12. R. Jothibasu and H. V. Huynh, *Organometallics*, 2009, **28**, 2505–2511.
13. P. M. Treichel, W. J. Knebel and R. W. Hess, *J. Am. Chem. Soc.*, 1971, **93**, 5424–5433.
14. R. Sustmann, *Tetrahedron Lett.*, 1971, **12**, 2717–2720.
15. N. A. Bokach, M. L. Kuznetsov and V. Y. Kukushkin, *Coord. Chem. Rev.*, 2011, **255**, 2946–2967.
16. a) A. S. Kritchenkov, N. A. Bokach, G. L. Starova and V. Y. Kukushkin, *Inorg. Chem.*, 2012, **51**, 11971; b) A. L. Mindich, N. A. Bokach, F. M. Dolgushin, M. Haukka, L. A. Lisitsyn, A. P. Zhdanov, K. Y. Zhizhin, S. A. Miltsov, N. T. Kuznetsov and V. Y. Kukushkin, *Organometallics*, 2012, **31**, 1716–1724; c) A. L. Mindich, N. A. Bokach, M. L. Kuznetsov, G. L. Starova, A. P. Zhdanov, K. Y. Zhizhin, S. A. Miltsov, N. T. Kuznetsov and V. Y. Kukushkin, *Organometallics*, 2013, **32**, 6576–6586; d) A. S. Kritchenkov, N. A. Bokach, M. L. Kuznetsov, F. M. Dolgushin, T. Q. Tung, A. P. Molchanov and V. Y. Kukushkin, *Organometallics*, 2012, **31**, 687–699.
17. a) M. L. Kuznetsov, V. Y. Kukushkin and A. J. L. Pombeiro, *J. Org. Chem.*, 2010, **75**, 1474–1490; b) N. A. Bokach, M. L. Kuznetsov, M. Haukka, V. I. Ovcharenko, E. V. Tretyakov and V. Y. Kukushkin, *Organometallics*, 2009, **28**, 1406–1413; c) M. L. Kuznetsov, V. Y. Kukushkin and A. J. L. Pombeiro, *Dalton Trans.*, 2008, 1312–1322; d) M. L. Kuznetsov, A. A. Nazarov, L. V. Kozlova and V. Y. Kukushkin, *J. Org. Chem.*, 2007, **72**, 4475–4477; e) M. L. Kuznetsov and V. Y. Kukushkin, *J. Org. Chem.*, 2006, **71**, 582–592; f) M. L. Kuznetsov, V. Y. Kukushkin, A. I. Dement'ev and A. J. L. Pombeiro, *J. Phys. Chem. A* 2003, **107**, 6108–6120.
18. A. S. Kritchenkov, K. V. Luzyanin, N. A. Bokach, M. L. Kuznetsov, V. V. Gurzhiy and V. Y. Kukushkin, *Organometallics*, 2013, **32**, 1979–1987.
19. a) A. S. Novikov, M. L. Kuznetsov and A. J. L. Pombeiro, *Chem.-A Eur. J.*, 2013, **19**, 2874–2888; b) A. S. Novikov, A. I. Dement'ev and Y. N. Medvedev, *Russ. J. Inorg. Chem.*, 2013, **58**, 320–330; c) A. S. Novikov and M. L. Kuznetsov, *Inorg. Chim. Acta*, 2012, **380**, 78–89.
20. R. A. Michelin, L. Zanotto, D. Braga, P. Sabatino and R. J. Angelici, *Inorg. Chem.*, 1988, **27**, 85–92.
21. Z. Otwinowski and W. Minor, in *Methods in Enzymology*, eds. J. C. W. Carter, R. M. Sweet and Eds, Academic Press, New York, 1997, vol. 276, pp. 307–326.
22. L. Palatinus and G. Chapuis, *J. Appl. Cryst.*, 2007, **40**, 786–790.
23. O. V. Dolomanov, L. J. Bourhis, R. J. Gildea, J. A. K. Howard and H. Puschmann, *J. Appl. Cryst.*, 2009, **42**, 339–341.
24. G. M. Sheldrick, *SADABS - Bruker AXS scaling and absorption correction*, Madison, Wisconsin, USA, 2012.
25. G. M. Sheldrick, *Acta Crystallogr. Sect. A*, 2007, **64**, 112–122.
26. a) A. D. Becke, *J. Chem. Phys.*, 1993, **98**, 5648–5652; b) C. Lee, W. Yang and R. G. Parr, *Phys. Rev.*, 1988, **B37**, 785.
27. M. J. Frisch, G. W. Trucks, H. B. Schlegel, G. E. Scuseria, M. A. Robb, J. R. Cheeseman, G. Scalmani, V. Barone, B. Mennucci, G. A. Petersson, H. Nakatsuji, M. Caricato, X. Li, H. P. Hratchian, A. F. Izmaylov, J. Bloino, G. Zheng, J. L. Sonnenberg, M. Hada, M. Ehara, K. Toyota, R. Fukuda, J. Hasegawa, M. Ishida, T. Nakajima, Y. Honda, O. Kitao, H. Nakai, T. Vreven, J. A. Montgomery, Jr., J. E. Peralta, F. Ogliaro, M. Bearpark, J. J. Heyd, E. Brothers, K. N. Kudin, V. N. Staroverov, R. Kobayashi, J. Normand, K. Raghavachari, A. Rendell, J. C. Burant, S. S. Iyengar, J. Tomasi, M. Cossi, N. Rega, N. J. Millam, M. Klene, J. E. Knox, J. B. Cross, V. Bakken, C. Adamo, J. Jaramillo, R. Gomperts, R. E. Stratmann, O. Yazyev, A. J. Austin, R. Cammi, C. Pomelli, J. W. Ochterski, R. L. Martin, K. Morokuma, V. G. Zakrzewski, G. A. Voth, P. Salvador, J. J. Dannenberg, S. Dapprich, A. D. Daniels, Ö. Farkas, J. B. Foresman, J. V. Ortiz, J. Cioslowski and D. J. Fox, *Gaussian 09, Revision C.01*, Gaussian, Inc., Wallingford CT, 2010.
28. D. Andrae, U. Häußermann, M. Dolg, H. Stoll and H. Preuß, *Theor. Chim. Acta*, 1990, **77**, 123–141.
29. a) C. Gonzalez and H. B. Schlegel, *J. Chem. Phys.*, 1991, **95**, 5853–5860; b) C. Gonzalez and H. B. Schlegel, *J. Chem. Phys.*, 1989, **90**, 2154–2161; c) C. Gonzalez and H. B. Schlegel, *J. Phys. Chem.*, 1990, **94**, 5523–5527.
30. V. Barone and M. Cossi, *J. Phys. Chem. A*, 1998, **102**, 1995–2001.
31. M. Cossi, G. Scalmani, N. Rega and V. Barone, *J. Comput. Chem.*, 2003, **24**, 669–681.
32. D. H. Wetz, *J. Am. Chem. Soc.*, 1980, **102**, 5316–5322.
33. J. Cooper and T. Ziegler, *Inorg. Chem.*, 2002, **41**, 6614–6622.

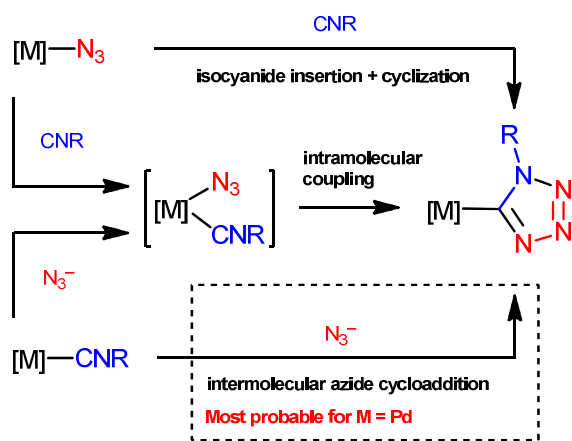

Generation of (tetrazolate)Pd^{II} complexes via integration of (isocyanide)Pd^{II} precursors with uncomplexed azides and verification of plausible reaction mechanisms.