

RSC Advances



This is an *Accepted Manuscript*, which has been through the Royal Society of Chemistry peer review process and has been accepted for publication.

Accepted Manuscripts are published online shortly after acceptance, before technical editing, formatting and proof reading. Using this free service, authors can make their results available to the community, in citable form, before we publish the edited article. This *Accepted Manuscript* will be replaced by the edited, formatted and paginated article as soon as this is available.

You can find more information about *Accepted Manuscripts* in the [Information for Authors](#).

Please note that technical editing may introduce minor changes to the text and/or graphics, which may alter content. The journal's standard [Terms & Conditions](#) and the [Ethical guidelines](#) still apply. In no event shall the Royal Society of Chemistry be held responsible for any errors or omissions in this *Accepted Manuscript* or any consequences arising from the use of any information it contains.

**Treatment of Coal Gasification Wastewater by Anaerobic SBR-Aerobic SBR Process
for Elimination of Toxic Organic Matters- A Lab Scale Study**

**Salma Tabassum ^{a,*}, Qinhong Ji^a, Sufia Hena^b, Chunfeng Chu^a, Guangxin Yu^c,
Zhenjia Zhang^{a,*}**

*^aSchool of Environmental Science and Engineering, Shanghai Jiao Tong University,
Shanghai 200240, China. E-mail: ustb456@sjtu.edu.cn*

*^bSchool of Industrial Technology, University Sains Malaysia, George Town, Penang,
11800, Malaysia*

*^cNew Energy Research Center, China National Offshore Oil Corporation Research
Institute, Beijing 100028, China*

Corresponding author Tel.: +86-15221195745; fax: +86 021-54740836

***E-mail addresses: salmazenith@gmail.com (S. Tabassum), zizhang@sjtu.edu.cn
(Z.Zhang)***

ABSTRACT

As a typical refractory industrial wastewater, coal gasification wastewater has a high toxicity and poor biodegradability. In this paper, an anaerobic SBR-aerobic SBR process was used to treat coal gasification wastewater. Average removal efficiency of COD, total phenols, volatile phenols, $\text{NH}_4^+\text{-N}$ were 65.1%, 79.6%, 99.5% and 99.39%, with final concentration in the effluent were 380 mg/L, 45.2 mg/L, 0.52 mg/L and 0.32 mg/L, respectively. There are 72 kinds of organic matters in the influent, a total of 10 categories. After biological treatment, the types and concentration of organic matters in the effluent of A(anaerobic 48 h effluent), B(anaerobic 48 h-aerobic 48h effluent), C(anaerobic 24 h effluent), D(anaerobic 24 h-aerobic 48 h effluent) has dropped significantly and the types of organic compounds were reduced to simpler 42,45,46 and 61 kinds, respectively. The process showed ascendancy in the treatment of toxic matters. Organics degradation and transformation were analysed by GC-MS. Additionally, microbial community analysis in anaerobic sludge was investigated by means of Polymerase chain reaction denaturing gradient gel electrophoresis (PCR-DGGE) along with SEM, revealed that it had a great variety of bacterial dominant species. The study demonstrated that hydrolytic acidification at SBR anaerobic 24 h+aerobic 48 h could be a technically feasible method to enhance $\text{NH}_4^+\text{-N}$, COD, TP removal and degradation of complex organic compounds in coal gasification wastewater.

Keywords: coal gasification wastewater, refractory organics, hydrolytic acidification, phenol, $\text{NH}_4^+\text{-N}$

1. Introduction

Coal gasification wastewater is a complex and toxic industrial wastewater, which is similar to coking wastewater but more recalcitrant¹⁻⁴. Coal gasification wastewater is discharged mainly from gas purification and condensing operations of coal gasifier. Due to its complex composition and high concentration of toxic pollutants contained in it², such as phenols, heterocyclic compounds, long-chain alkanes, aromatic hydrocarbons, ammonia nitrogen and cyanogens, most of which have been reported to be carcinogenic and mutative⁵⁻⁹ it is considered as the most serious environmental problem. The toxic pollutants presence in the coal gasification wastewater can be affected by coal quality, gasification process and pre-treatment section; the variation extent of its water quality is huge^{10, 11}. After the physico-chemical pre-treatment, it is usually treated by a series of biological treatment to reduce concentration of phenols and ammonium^{12, 13} followed by advanced treatment for removal of chromaticity and residual refractory organics. Usually after biological treatment, phenols, cyanides and Biochemical Oxygen Demand (BOD₅) meets emission standards, but Chemical Oxygen Demand (COD) and ammonia nitrogen are still hard to meet for example in aquatic life, ammonia in the form of free ammonia is the worst contaminants¹⁴.

In the presence of high organic content and inhibitory compounds contained in the wastewater, the removal of ammonia by autotrophic nitrification is sometimes affected severely^{15, 16} by fast growing heterogeneous bacteria¹⁷.

There are certain limitations when employing anaerobic or aerobic process individually for treating coal gasification wastewater^{18,19} as alone they cannot produce effluents that comply with the effluent discharge guidelines. Therefore, the A-O process and A²O process become the main biological treatment technology for coal gasification wastewater. Most of studies focused on the removing rate of pollutant of the whole process and the influence of operation parameters on the pollutant removal efficiency²⁰⁻²². However, there are few studies about the comparison of various reaction stages on pollutants removal effect, as well as detailed study of the domestication process of reactor.

In this present study, a lab scale sequencing batch reactors or sequential batch reactors (SBR) are used for the treatment of coal gasification wastewater. As SBRs offers an effective way to achieve lower effluent limits. Due to improvements in equipment and technology, particularly in aeration devices and computer control systems have made SBRs a practicable choice over the conventional activated sludge system²³. Previous studies showed that SBR appears to be promising option for the effective treatment of industrial wastewater^{24,25}.

This study aims to investigate the feasibility of the anaerobic SBR- aerobic SBR system to treat coal gasification wastewater by analysing its performance in each reaction section for the degradation of complex organic pollutant (qualitatively and quantitatively). They were analyzed at different hydrolytic acidification by a gas chromatography mass spectrometer (GC-MS) along with stress on absolute removal of NH₄⁺-N, COD, and total phenol (TP). A treatment system in which organic contaminants are removed

simultaneously and effectively is adopted in this study. The role of microbial phase in removal of the pollutants was investigated by Scanning electron microscopy (SEM) and Polymerase chain reaction denaturing gradient gel electrophoresis (PCR-DGGE).

2. Material and methods

2.1 Experimental setup

The schematic diagram of anaerobic SBR-aerobic SBR process used in this study is shown in Fig.1. Anaerobic and aerobic reactors are both cylindrical plexiglass jars. The walls of each jar comprises of thermal insulating material which provides for steady thermal gradients to be established throughout the walls of the jars, and temperature of the reaction can be adjusted through a temperature control device as seen in Fig. 1. Effective volume of anaerobic reactor was 5L is equipped with a stirrer having stirring rate around 100 r/min.

Dissolved Oxygen (DO) is a very necessary aspect of activated sludge operation. Anaerobic reactor was operated under mesophilic condition (35 ± 1 °C) and DO was maintained between 0-0.5 mg/L. The influent in this study was not aerated or stirred, which is important to control the DO value at low ($0 \sim 0.5$ mg/L). For instance in the practical wastewater treatment engineering, there is no aeration in the quality regulation pool of wastewater, which can keep the DO value of the wastewater at about 0mg/L. In this study, we used the dissolved oxygen meter to measure the DO value of the influent in the storage bucket. If the value of DO is more than 0.5 mg/L, and the value of DO was reduced to below 0.5 mg/L, it is adjusted by adding the sodium sulfite to the influent. As for the value

of DO in the anaerobic SBR reactor was controlled below 0.5 mg/L, it is generally believed that when $DO < 0.5$ mg/L, the anaerobic hydrolysis reaction will not be affected.

DO in the aerobic reactor was kept between 3-4 mg/L (turbine aeration units) throughout the whole experimental period. Effective volume of aerobic reactor was 4 L, equipped with aeration head operated under 25 ± 1 °C mesophilic condition. The DO of wastewater in the aerobic SBR reactor was consumed by the microbial reactions, and the microbial reactions were inhibited by the low DO. Therefore, in our study the value of DO was controlled at 3-4 mg/L. While the DO of the aerobic SBR reactor was control by adjusting the air flow rate of the blower. And we also used the dissolved oxygen meter to measure the DO value in the aerobic SBR reactor.

2.2 Coal gasification wastewater

The physico-chemical pre-treatment coal gasification wastewater was received from the Coal Long Hua Harbin Coal Chemical Industry Co. Ltd, Harbin, China. The raw wastewater had a pH of 7.62-8.14, COD concentration of 950-1200 mg/L, total nitrogen (TN) concentration of 123-140 mg/L, 190-240 mg/L total phenol (TP), 83-115 mg/L volatile phenol (VP), and an NH_4^+ -N concentration of 81-110 mg/L. In addition, the BOD/COD ratio between 0.11-0.18 which shows that it has an extremely poor biodegradability.

The wastewater had a significantly higher phenolic content (65.51%) along with other predominant organic compounds like carboxylic acids, heterocyclic compounds, long chain alkanes, ketones etc. At the same time, the trace elements were added to the anaerobic

reactor in order to provide a balance feed for microbial growth, which consisted of the following nutrients (in mg/L): $\text{FeSO}_4 \cdot 7\text{H}_2\text{O}$ 15, $\text{MgSO}_4 \cdot 7\text{H}_2\text{O}$ 50, $\text{MnCl}_2 \cdot 4\text{H}_2\text{O}$ 0.5, ZnCl_2 0.5, CuCl_2 0.5, $\text{NaBO}_2 \cdot 10\text{H}_2\text{O}$ 0.3, AlCl_3 0.5, $\text{CoCl}_2 \cdot 2\text{H}_2\text{O}$ 0.5 and $\text{NiCl}_2 \cdot 2\text{H}_2\text{O}$ 0.5.

2.3 Inoculated sludge

Granular sludge of anaerobic SBR reactor was taken from the industrial scale anaerobic reactor, which was used for treating citric acid wastewater. The raw coal gasification wastewater was used to domesticate the granular sludge. The granular sludge was domesticated for a total of 20 cycles, and the reaction time of each cycle is 64 hours. The domesticated granular sludge was inoculated into the anaerobic SBR reactor. The mixed liquor suspended solids (MLSS) and mixed liquor volatile suspended solids (MLVSS) value of the anaerobic SBR reactors were 4659 mg/L and 3489 mg/L, respectively, and the value of Volatile suspended solids (VSS) to total suspended solids (SS) ratio was 0.75

The inoculated sludge in aerobic reactor employs the activated sludge from aeration tank in the sewage treatment plant in Suzhou Industrial Park, Suzhou district, China. Before inoculation, running water was aerated for 24 hours. After inoculation, MLSS in the reactor was nearly 4350 mg/L, and MLVSS was nearly 3202 mg/L, VSS/SS ratio was about 0.74.

2.4. Experimental set-up and Operation

Determination of anaerobic hydrolytic acidification time

The raw coal gasification wastewater (220 ml) was added into 300 ml serum bottle, along with the domesticated granular sludge (30 ml) taken from the anaerobic reactor. Three serum bottles were run simultaneously. Each serum bottle contains test samples (Total volume 250 ml), and 20% volume (50 ml) of the serum bottle was left as gas space. The MLSS value of each serum bottle remains similar to the MLSS value of anaerobic SBR reactor. The serum bottles were sealed with rubber stopper. In order to discharge the residual gas in the serum bottles, such as CO₂, O₂, H₂, etc., the pure N₂ was added into the serum bottle. After the pressure within a serum bottle was balanced, the serum bottles were placed in the shaking water bath, and the temperature of the shaking bath was controlled at 35 °C.

Gas chromatographic analyses was conducted, a syringe was used to take out the gas from the serum bottle at regular intervals. The gas produced from the serum bottle was taken out by syringe at regular intervals, and the composition of the gas was analyzed by gas chromatography. The gas chromatograms of different reaction time were compared and analyzed. When the methane peak appeared in the gas chromatograms, it suggested that the anaerobic hydrolytic acidification phase was over, and the anaerobic system steps into the methanogenic phase. This reaction time (according to the gas chromatograms with the methane peak) was determined as the anaerobic hydrolytic acidification time.

Operation of the reactor

The operation mode of the anaerobic SBR reactor and aerobic SBR reactor was intermittent. Coal gasification waste water was intermittently fed into each reactor from the

top, and discharged by using the siphon method. The running cycle of the anaerobic SBR reactor and aerobic SBR reactor consists of a filling stage, reaction stage, settling stage and drainage stage²⁶, and the period of each stage is different.

In sequence, the running cycle of each stage of the anaerobic SBR reactor is as follow: 0.1 h (filling), 48 h or 24 h (reaction), 4 h (settling), and 0.1 h (drainage stage). For the period of each stage of the aerobic SBR reactor is as follow: 0.1 h (filling), 48 h (reaction), 3 h (settling), and 0.1 h (drainage stage).

In this study, the anaerobic SBR-aerobic SBR system was carried out 62 running cycles together. The total running time of the reaction stage of the anaerobic SBR-aerobic SBR system for 1-28 cycles was 96 h (anaerobic 48 h + aerobic 48 h) and for 29-62 cycles the total running time was 72 h (anaerobic 24 h + aerobic 48 h). The effluent of anaerobic SBR reactor enters in aerobic SBR reactor, 1 g/L NaHCO₃ was added to supplement alkalinity required for nitrification. After the performance of the anaerobic SBR-aerobic SBR system reached a steady state, samples were collected for analysis.

2.5 Analytical methods

After centrifugation and filtration biochemical reaction effluent, water quality analysis was conducted. COD, BOD₅, total nitrogen, NH₃-N, volatile acids, total phosphorus, SS and VSS were analysed according to standard methods²⁷. Concentrations of total phenols and volatile phenols (VP) were measured by the bromide volumetric method and predistillation-bromide volumetric method²⁷. Wastewater samples for GC/MS analysis were firstly filtered by a 0.45 µm membrane filter and extracted by CH₂Cl₂ into

neutral, basic and acid phases (repeated three times for each phase) and then concentrated by evaporating in a water bath at 40 °C. The concentrated samples with a volume of 0.2 µL were analysed by GC: SHIMADZU GC-14B and Agilent 7890-5975 GC/MS equipment. chromatographic conditions: DB-5 column (0.32mm×30m), inlet temperature 280 °C, helium carrier gas, flow rate of 1 mL/min, split ratio of 20: 1, the heating process for the initial temperature 30 °C, warming rate 3 °C/min, final temperature 280 °C; MS conditions: EI source temperature 220 °C, electron energy 70eV, emission current 250 µA, mass analyzer interface temperature 250 °C, scan range of m/z 30-500.

The analytical conditions were described in the previous paper²⁸. pH is one of the key parameters measured in wastewater treatment systems, since its control is important to maintain the biological activity of microorganisms involved in the treatment process. pH measurements were performed with an electrode (Crison Instruments, S.A., 52-03) equipped with an automatic compensatory temperature device (Crison Instruments, S.A., 21-910-01) and connected to a measure instrument (pH mV-1). Microorganisms in biomass were observed using a scan electron microscope (Digital SEM Leica 440 at 20 kV) controlled with a computer system. The microorganism profile was determined by using PCR-DGGE.

3. Results and Discussion

3.1 Degradation efficiency of SBR anaerobic and SBR aerobic reactors under different hydrolytic acidification time

The system has been operated for 62 cycles. During the operation, hydrolytic acidification time was gradually shortened for the domestication of anaerobic granular sludge and makes it possess the ability to degrade the organic matter from coal gasification wastewater.

From 1st to 28th cycle, hydrolytic acidification time in the reactor was maintained at 48 h, organic influent load was nearly 0.6 kgCOD/m³·d and total phenolic load was 0.11 kg/m³·d. Anaerobic section makes a significant contribution to the COD removal efficiency of 69.5±1.9% and a volatile phenol removal efficiency of 98.6±1.4%, respectively.

For anaerobic 48h+aerobic 48h, with an Influent concentration of COD 1071±32 mg/L, 221.5±17.4 mg/L of TP, 98.1±14.7 mg/L of VP, and 91.2±10.7 mg/L of NH₄⁺-N, the anaerobic effluent COD, TP, VP and NH₄⁺-N could be decreased to 645.3±16.1 mg/L, 107.8±7.8 mg/L, 1.47±1.47 mg/L and 96±10.7 mg/L, respectively.

The aerobic effluent concentration for anaerobic 48h+aerobic 48h was COD 443±8 mg/L, 33.3±2.9 mg/L of TP, 0.22±0.22 mg/L of VP, and 0.64±0.56 mg/L of NH₄⁺-N showing average removal efficiencies of COD, total phenol, volatile phenol, and ammonium nitrogen of 59.6%, 84.6%, 99.8% , and 98.7, respectively.

Volatile phenol was almost removed completely in anaerobic section. Pollutant degradation performance in each reaction section is shown in Fig. 2a-g.

Shake flask experiment were conducted when anaerobic sludge has been domesticated (28 cycles). Through GC analysis, methane production begins after 24 hours of reaction. So, from 29th cycle-62 cycle, hydrolytic acidification time was shortened to 24

h, and organic load and total phenols load was elevated to $1.2 \text{ kgCOD/m}^3\cdot\text{d}$ and $0.22 \text{ kg/m}^3\cdot\text{d}$. Since the hydrolytic acidification time was reduced COD, Total phenols and volatile phenol removal efficiency in aerobic section increases.

For anaerobic 24 h+aerobic 48 h, with an Influent concentration of COD $1102\pm 20 \text{ mg/L}$, $219.9\pm 19.2 \text{ mg/L}$ of TP, $99.9\pm 13.8 \text{ mg/L}$ of VP, and $98.8\pm 11.6 \text{ mg/L}$ of $\text{NH}_4^+\text{-N}$, the anaerobic effluent COD, TP, VP and $\text{NH}_4^+\text{-N}$ could be decreased to $800.5\pm 12.8 \text{ mg/L}$, $153\pm 7.2 \text{ mg/L}$, $33.7\pm 7.1 \text{ mg/L}$ and $105.8\pm 12.2 \text{ mg/L}$, respectively.

The aerobic effluent concentration for anaerobic 24 h+aerobic 48 h was COD $380\pm 13 \text{ mg/L}$, $45.2\pm 4.6 \text{ mg/L}$ of TP, $0.52\pm 0.52 \text{ mg/L}$ of VP, and $0.17\pm 0.15 \text{ mg/L}$ of $\text{NH}_4^+\text{-N}$ showing average removal efficiencies of COD, total phenol, volatile phenol, and ammonium nitrogen of 65.1%, 79.6%, 99.5% , and 99.0, respectively.

Most of total phenols removal occurred in aerobic section. In wastewater, volatile phenol accounts for nearly 37.7%~56.9% of total phenols, and the removal of volatile phenol was significantly higher than that of total phenols. This is the main reason for the reduction of phenols in the system.

Meanwhile, when the operation of the aerobic SBR reactor was stable, the change of the concentration of $\text{NH}_4^+\text{-N}$, $\text{NO}_2^-\text{-N}$ and $\text{NO}_3^-\text{-N}$ was detected in the reaction stage of the 50th cycle(Anaerobic 24 h + Aerobic 48 h), which could further determine the nitrification effect of the aerobic SBR reactor, and the experimental result was shown in figure 2 (h).From figure 2 (h), the concentration of $\text{NH}_4^+\text{-N}$ rapidly decreased from 86.17 mg/L to 18.45 mg/L in the previous 6 hours, the $\text{NH}_4^+\text{-N}$ removal rate reached 78.6% in 6th hours.

And after 20th hours, the concentration of $\text{NH}_4^+\text{-N}$ is less than 1 mg/L. The concentration of $\text{NO}_2^-\text{-N}$ is on the rise, and the maximum concentration is 43.84 mg/L in 6th hours, after that the concentration of $\text{NO}_2^-\text{-N}$ gradually reduced to less than 1 mg/L. It means that no $\text{NO}_2^-\text{-N}$ accumulation phenomenon occurs in the aerobic reactor. Moreover, it also can be seen that the concentration of $\text{NO}_3^-\text{-N}$ is on the rise, and reached 93.76 mg/L in 20th hours. It shows that $\text{NH}_4^+\text{-N}$ and $\text{NO}_2^-\text{-N}$ could be effectively transformed into $\text{NO}_3^-\text{-N}$ in the aerobic SBR reactor.

$\text{NH}_4^+\text{-N}$ in anaerobic effluent was slightly higher than that in influent, mainly because anaerobic bacteria degrade nitrogenous organics and release $\text{NH}_4^+\text{-N}$. Ammonia nitrogen concentration of system effluent was less than 1 mg/L (Fig. 2g), average removal efficiency 99.39%, that is far below the Integrated Wastewater Discharge Standard (GB8978-1996). Although $\text{NH}_4^+\text{-N}$ in existing examples of coal gasification wastewater biological treatment can meet emission standard, but rarely were able to achieve the $\text{NH}_4^+\text{-N}$ in effluent lower than 1mg/L. For instance, Xu¹ adopted anaerobic–anoxic–oxic membrane reactor (A^2O -MBR) system to treat coal gasification wastewater $\text{NH}_4^+\text{-N}$ in influent was 110~165 mg/L, $\text{NH}_4^+\text{-N}$ in effluent was 9.6 mg/L. Yang²⁹ adopted two combined pre-denitrification anaerobic/aerobic processes (AOAO system and A^2O^2 system) for the treatment of coal gasification wastewater $\text{NH}_4^+\text{-N}$ in influent was 100~135 mg/L, $\text{NH}_4^+\text{-N}$ in effluent was 11.6 mg/L.

It can be seen that the ammonia nitrogen concentration of influent and the hydraulic retention time in the present study, was similar to the two previous studies A^2O -

MBR system¹ and (AOAO system and A²O² system)²⁹ they are the typical examples for coal gasification wastewater treatment system. But the experimental results show that the ammonia nitrogen concentration of effluent of the aerobic SBR reactor is less than 1 mg/L in the present study, and the ammonia nitrogen removal efficiency reached 99.39%, which is far better than the results of the previous studies^{1, 29}.

The reasons for the low NH₄⁺-N removal efficiency are that, firstly, toxic and hazardous substances such as phenol, cresol, alkyl naphthylamine and alkyl pyridine have inhibiting effects on nitrifying bacteria activity^{30, 31}; secondly, the competition for DO between heterotrophic bacteria and autotrophic bacteria can also affect nitrification. Therefore, the removal of hazardous substances such as phenols and the reduction of COD are the precondition to increase NH₄⁺-N removal efficiency. The high efficiency NH₄⁺-N removal treatment in this study is mainly due to firstly, hydrolytic acidification section plays a pre-treatment role in the open-loop and detoxification of toxic and refractory substances, alleviates the load in aerobic section, and weakens the toxic and inhibiting effects on nitrifying bacteria; secondly, the aerobic section operates intermittently, making the sludge not easy to run off. SRT is quite long, making conditions for the growth and reproduction of nitrifying bacteria.

Through continual domestication to anaerobic and aerobic sludge, although hydrolytic acidification time is substantially shortened during stable operation, the COD removal efficiency of anaerobic 24 h+aerobic 48 h is also much higher than that of anaerobic 48 h+aerobic 48 h as can be seen from Fig. 2. The removal of total phenols and volatile phenols is approximately equal as well. The pollutant removal efficiency of the system is

substantially elevated, the operation cycle were shortened as the total average removal efficiency of COD, total phenols, volatile phenols, $\text{NH}_4^+\text{-N}$ were 65.1%, 79.6%, 99.5% and 99.39%, with the final concentration in the aerobic reactor effluent were 380 mg/L, 45.2 mg/L, 0.52 mg/L and 0.32 mg/L, respectively. With anaerobic sludge acclimation, the treatment effect of anaerobic SBR-aerobic SBR system gets better. And the total running time of the reaction stage of the anaerobic SBR-aerobic SBR system for 1-28 cycles was 96h (anaerobic 48 h + aerobic 48 h) and for 29-62 cycles the total running time was shortened to 72 h (anaerobic 24 h + aerobic 48 h).

3.2 GC-MS analysis of degradation of organics in each section

In order to further analyse the biodegradation of organic matter in coal gasification wastewater. GC-MS analysis of influent and effluent of anaerobic 24 h, anaerobic 24 h+aerobic 48 h, anaerobic 48 h and anaerobic 48 h+aerobic 48 h (Fig. 3) were done along with the comparison of the organic components in each unit, and organic matter removal efficiency in each unit were also evaluated.

Through NIST database identification of organic matters was done. Table 1 is the analysis of organic compounds (similarity>80%) in influent and effluent of each section. Table 2 shows the result obtained after classification and normalization of the organic compounds of Table 1.

There are 71 kinds of main organic compounds in the influent. The most important components are phenols and carboxylic acids, respectively accounting for 65.51% and 20.25% of the total components. Ketones, alkanes and heterocyclic compounds are the

second major components, altogether accounting for 9.92%. Overall, after biological treatment, the types of organic compounds in the effluent of A, B, C, D section are respectively reduced to 42, 45, 45 and 61. Most phenols, carboxylic acids and ketones were degraded. This is the main reason for the reduction of COD. However, some structurally complex organics such as heterocyclic, polycyclic compounds, lipids, alkanes and amines were partially remained³²; it was difficult for biochemical treatment.

Anaerobic acidification process plays an important role in the simplification of complex organics and the improvement of wastewater biodegradability. The main phenolic compounds in the influent were mainly phenol and methyl phenol. After anaerobic treatment, the relative content of phenol was reduced significantly. This should be the main reason for the reduction of volatile phenols, and indicates that phenol was easy to be degraded although the influent has a high toxicity and inhibiting effect on microorganisms. In comparison, the relative content of methyl phenol increases, which was possibly due to the anaerobic degradation performance of alkyl phenol, was relatively poor and the degradation rate was lower than the phenol's. Some complex organic compounds such as Phthalimidine, 2-methyl-2-cyclopenten-1-one and 5-acetyl-2-methyl-pyridine were completely degraded in the anaerobic section, indicating that the anaerobic section possesses relatively good degradation performance of certain refractory organic compounds. Some new substances are produced in the anaerobic process, such as 2,2'-biphenol, 4,4'-(1-methylethylidene) bisphenol and isobutyl-3-vinyl phthalate. They may be intermediate products produced after biodegradation of many complex organic compounds in raw wastewater. Another possibility is that the organic matter concentration was

relatively low in the influent, so it was not detected. Furthermore, the contents of all kinds of benzoic acids in the anaerobic effluent increase significantly, indicating that under mesophilic anaerobic conditions, the intermediate product of phenols degradation is likely to be benzoic acid which is consistent with large number of previous studies^{33,34}.

After aerobic treatment, phenols and carboxylic acids were almost completely removed. There are several kinds of alkyl benzenes, alkanes and heterocyclic compounds in the effluent. The sum of these three kinds of substances respectively accounts for 51.15% and 38.77% in total organic components in anaerobic 24 h+aerobic 48 h effluent and anaerobic 48 h+aerobic 48 h effluent. Alkyl benzenes do not exist in the raw wastewater and anaerobic section, but accounted for 19.36% and 11.48% in anaerobic 24 h+aerobic 48 h effluent and anaerobic 48 h+aerobic 48 h effluent, respectively. There may be new substances produced in the aerobic biodegradation process of benzene compounds. Relatively short carbon chains (such as hexadecane, heptadecane and nonadecane) had lower content in the influent, but their content increases in the effluent. This is due to the conversion of long-chain alkanes (such as hexacosane, 2-methyl-octacosane and dotriacontane) into short-chain alkanes through biochemical reaction process. Heterocyclic compounds were poorly removed in the aerobic section due to their toxicity and inhibitory effect.

Overall, SBR anaerobic–SBR aerobic system proved to be effective to remove the phenolic as well as inhibitory recalcitrant organic pollutants from coal gasification wastewater.

3.3 SEM observation of anaerobic-aerobic sludge

In order to observe the structural characteristics of sludge microorganisms in anaerobic reactor, the internal and external structure of sludge and various stages were analysed by SEM as shown in Fig. 4(a-d). Flocculent sludge was dominant in anaerobic reactor. Through SEM observation, the structure of bacterial colony was quite complex, and there was distinctive distribution of streptococcus, filamentous bacteria, brevibacterium and coccus.

Fig. 4(e) and Fig 4(f) are SEM for aerobic sludge. Through SEM observation, the form and structure of aerobic sludge bacteria are quite clear, and there is an intensive distribution of a large number of spherical bacteria, maybe due to the beginning of continual reproduction and concentration of nitrifying bacteria. As can be seen from the Fig. 4 bacteria tend to grow in a more flocky structure.

3.4 PCR- DGGE results

In order to understand the microbial reactions and their role in pollutants removal, the analysis of the microbial community is very crucial. Fig. 5 shows the result of microbial community analysis detected by DGGE profiles of 16S rDNA gene fragments amplified from DNA extraction of biomass obtained from anaerobic sludge. Among the detectable bands in the DGGE profiles, bands 1, 2, 3, 4, 5, 6, 11, 15, 16, 17 were common in the three samples (inoculated sludge, sludge after 20 cycles of domestication and sludge after 52 cycles of domestication) as can be seen from the Fig. 5. Band 6 showed the highest intensity in the sample from the inoculated sludge, and bands 1, 3, 4 and 11 appeared with

highest intensity in the sludge after 20 cycles of domestication sample. For the samples from sludge after 52 cycles of domestication bands of highest intensity were 1, 3, 4, 5, 6, 11, 16 and 17.

In the anaerobic reaction stable system after domestication of coal gasification wastewater, the microbial community was mainly proteobacteria, most of which belong to mesophilic bacteria.

In the system there exist typical anaerobic micro floras such as syntrophobacter (may be syntrophism bacillus), denitrifying bacteria and sulphate-reducing bacteria, and they play important roles in the anaerobic treatment of COD and phenols; *Desulfovibrio*-related populations are also presents, It has been proposed that *Desulfovibrio* species grow as acetogens in syntrophic association with methanogens³⁵. Hydrocarbon degrading bacteria in the consortium was *Acinetobacter*. Sulphate-reducing syntrophobacteraceae were also present. Simultaneously, there also exist aerobic micro floras like acinetobacter in the hydrolytic acidification system, and they play different metabolism roles from anaerobic micro floras.

Conclusions

The SBR anaerobic 24 h+aerobic 48 h system is a effective and reliable technique for the biological treatment of coal gasification wastewater, even though with high concentration of toxic compounds present in coal gasification wastewater. It provides a way for flexibility in variation of operating conditions to achieve desired results for its time oriented rather than space. SBR anaerobic 24 h+aerobic 48 h system was remarkably stable

for over a half year. After biological treatment, most phenols, carboxylic acids, ketones as well as inhibitory recalcitrant organic pollutants were degraded. The process showed superiority in the treatment of ammonia nitrogen having average removal efficiency 99.39%. Pollutant removal efficiency of the system was substantially elevated and operation cycles were shortened. Microbial analysis such as SEM, PCR-DGGE showed that the dominant bacterial species were consistent with the removal of typical hazardous pollutants. The combined process could be an attractive way to efficiently, effectively and simultaneously treat organic pollutant from the troublesome coal gasification wastewater which leads to a negligible environmental and ecological impact.

Acknowledgements

The research team would like to acknowledge and give special thanks to Hua Zhu, Wenhua Wu, Mengjia Zhu for contributing to the success of this study. The authors express their gratitude to the School of Environmental Science and Engineering, Shanghai Jiao Tong University for providing the research facilities.

References

1. Z. Wang, X. Xu, Z. Gong and F. Yang, *Journal of Hazardous Materials*, 2012, 235–236, 78-84.
2. X. Zhu, J. Ni and P. Lai, *Water Research*, 2009, 43, 4347-4355.
3. C. Li, S. Tabassum and Z. Zhang, *RSC Advances*, 2014, 4, 57580 - 57586.
4. C. Li, S. Tabassum and Z. Zhang, *RSC Advances*, 2014, 4, 35156 - 35162.
5. D. Bamelis, *Rev. Metall.*, 1992.
6. D. Jenkins, *Water Science and Technology*, 1992, 25, 215–230.
7. W. Keith and J. Antil, *Steel Time Int.*, 1991, 26-35.
8. Y. Qian, Y. Wen and H. Zhan, *Water research*, 1994, 28, 701–710.
9. R. F. Yu, Fudan University Press, Shanghai, China, 1989.
10. H. Li, H. Han, M. Du and W. Wang, *Journal of Environmental Sciences*, 2011, 23, 568-574.
11. H. Li, H. Han, M. Du and W. Wang, *Bioresource Technology*, 2011, 102, 4667-4673.
12. M. K. Ghose, *Water Research*, 2002, 36, 1127-1134.
13. D. Park, D. S. Lee, Y. M. Kim and J. M. Park, *Bioresource Technology*, 2008, 99, 2092-2096.
14. S. W. Effler, C. M. Brooks, M. T. Auer and S. M. Doerr, *Research Journal of the Water Pollution Control Federation*, 1990, 62, 771–779.
15. A. B. Gupta and S. K. Gupta, *Water Research*, 2001, 35, 1714-1722.
16. S. Okabe, Y. Oozawa, K. Hirata and Y. Watanabe, *Water Research*, 1996, 30, 1563-1572.
17. J. Ling and S. Chen, *Aquacultural Engineering*, 2005, 33, 150-162.
18. Y. J. Chan, M. F. Chong, C. L. Law and D. G. Hassell, *Chemical Engineering Journal*, 2009, 155, 1-18.
19. M. Hong, Q. Li and X. Deng, *Environmental Protection of Chemical Industry*, 2005, 25, 104-109.
20. F. Guan, G. Gao and Q. Zhao, *China Water & Wastewater*, 2009, 25, 74-76.
21. W. Zhao, X. Wang and B. Gao, *Chinese Journal of Environmental Engineering*, 2012, 6, 3481-3484.
22. Q. Xu, S. Bao and J. Cai, *Water Purification Technology*, 2011, 30, 39-41.
23. W. S. Al-Rekabi, H. Qiang and W. W. Qiang, *Pakistan Journal of Nutrition*, 2007, 6, 11-19.
24. E. GÜRTEKİN, presented in part at the 2ND INTERNATIONAL SYMPOSIUM ON ENVIRONMENT AND MORALITY, Adiyaman University 24-26 Oct 2014, 2014.
25. U. S. E. P. A. Wastewater, in *EPA 932-F-99-073. 1999*, ed. U. S. E. P. Agency, Office of Water, Washington, D.C., 1999.
26. S. Sathian, M. Rajasimman, G. Radha, V. Shanmugapriya and C. Karthikeyan, *Alexandria Engineering Journal*, 2014, 53, 417-426.
27. APHA, ed. AWWA, APHA:Washington DC, 20 edn., 1999.
28. M. Zhang, J. H. Tay, Y. Qian and X. S. Gu, *Water Research*, 1998, 32, 519-527.
29. Z. Wang, X. Xu, J. Chen and F. Yang, *Journal of Environmental Chemical Engineering*, 2013, 1, 899-905.
30. M. R. Hockenbury and C. P. L. Grady, *Journal of the Water Pollution Control Federation* 1977, 49 768-777.
31. D. Paredes, P. Kuschek and T. Mbwette, *Engineering in Life Sciences*, 2007, 7, 13-25.
32. Y. Chen, J. J. Cheng and K. S. Creamer, *Bioresource Technology*, 2008, 99, 4044-4064.
33. G. Knoll and J. Winter, *Applied Microbiology and Biotechnology*, 1987, 25, 384-391.

34. T. Kobayashi, T. Hashinaga, E. Mikami and T. Suzuki, *Water Science and Technology*, 1989, 21, 55-65.
35. M. P. Bryant, L. L. Campbell, C. A. Reddy and M. R. Crabill, *Applied and Environmental Microbiology*, 1977, 33, 1162-1169.

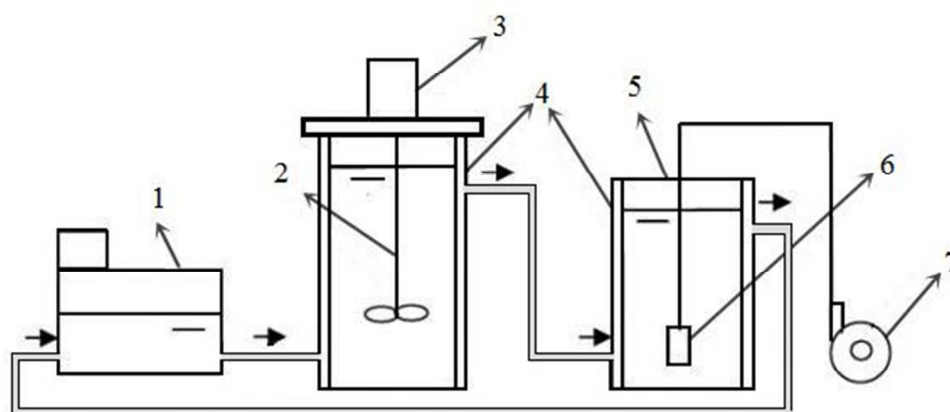

Figure 1. Schematic diagram and Photographic presentation of anaerobic SBR and aerobic SBR system treating coal gasification wastewater (1) temperature controller, (2) stirrer; (3) anaerobic SBR reactor, (4) circulating water jacket, (5) aerobic SBR reactor, (6) aerator, (7) blower.
157x187mm (96 x 96 DPI)

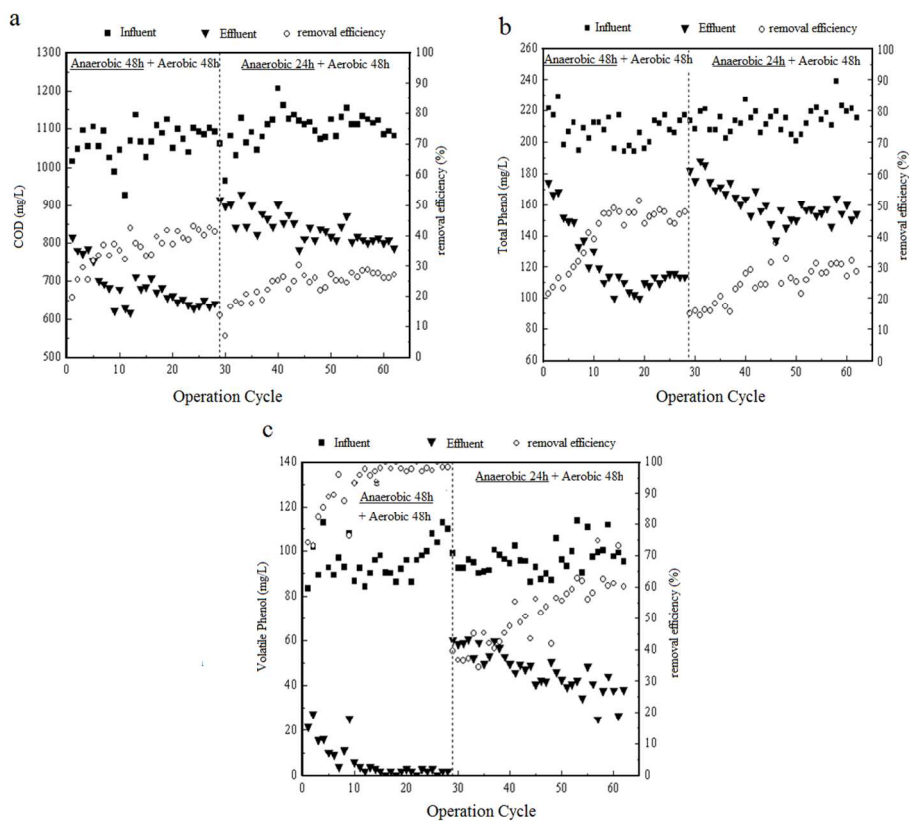

Figure 2. (a) COD degradation during anaerobic hydrolysis acidification, (b) total phenol degradation during anaerobic hydrolysis acidification, (c) volatile phenol degradation during anaerobic hydrolysis acidification, (d) Intermittent aerobic removal of COD, (e) Intermittent aerobic removal of total phenol, (f) Intermittent aerobic removal of volatile phenol, (g) Intermittent aerobic removal of Ammonia and (h) the changes in the concentration of NH_4^+-N , NO_2--N and NO_3--N in the aerobic SBR reactor (in the reaction stage of the 50th cycle, Anaerobic 24 h + Aerobic 48 h)

327x304mm (96 x 96 DPI)

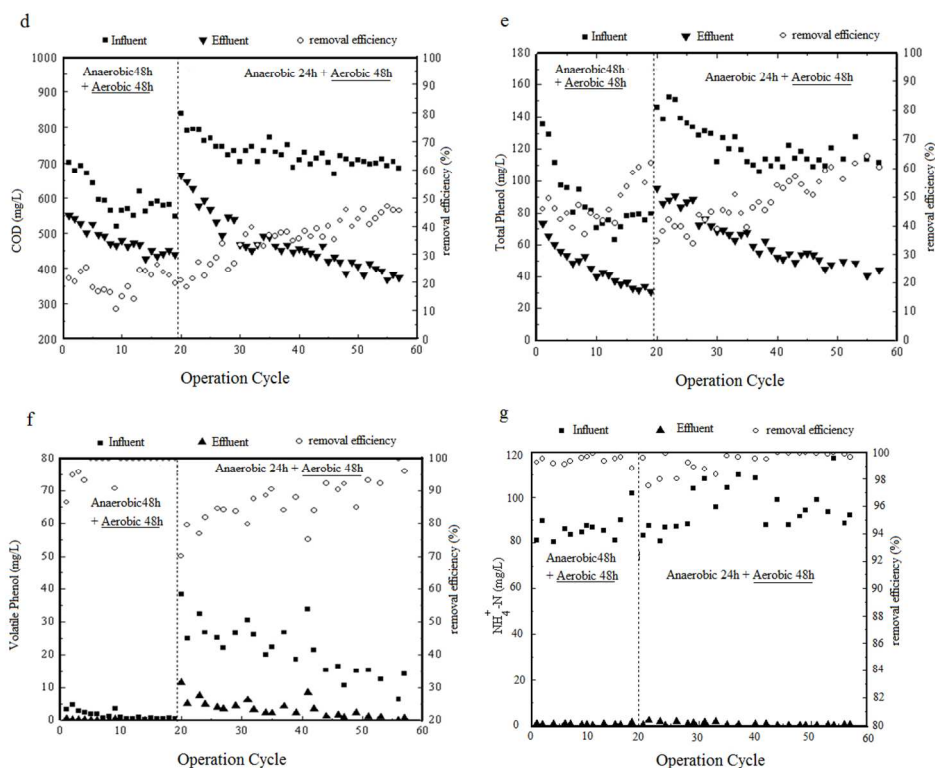

Figure 2. (a) COD degradation during anaerobic hydrolysis acidification, (b) total phenol degradation during anaerobic hydrolysis acidification, (c) volatile phenol degradation during anaerobic hydrolysis acidification, (d) Intermittent aerobic removal of COD, (e) Intermittent aerobic removal of total phenol, (f) Intermittent aerobic removal of volatile phenol, (g) Intermittent aerobic removal of Ammonia and (h) the changes in the concentration of $\text{NH}_4^+\text{-N}$, $\text{NO}_2^-\text{-N}$ and $\text{NO}_3^-\text{-N}$ in the aerobic SBR reactor (in the reaction stage of the 50th cycle, Anaerobic 24 h + Aerobic 48 h)
328x292mm (96 x 96 DPI)

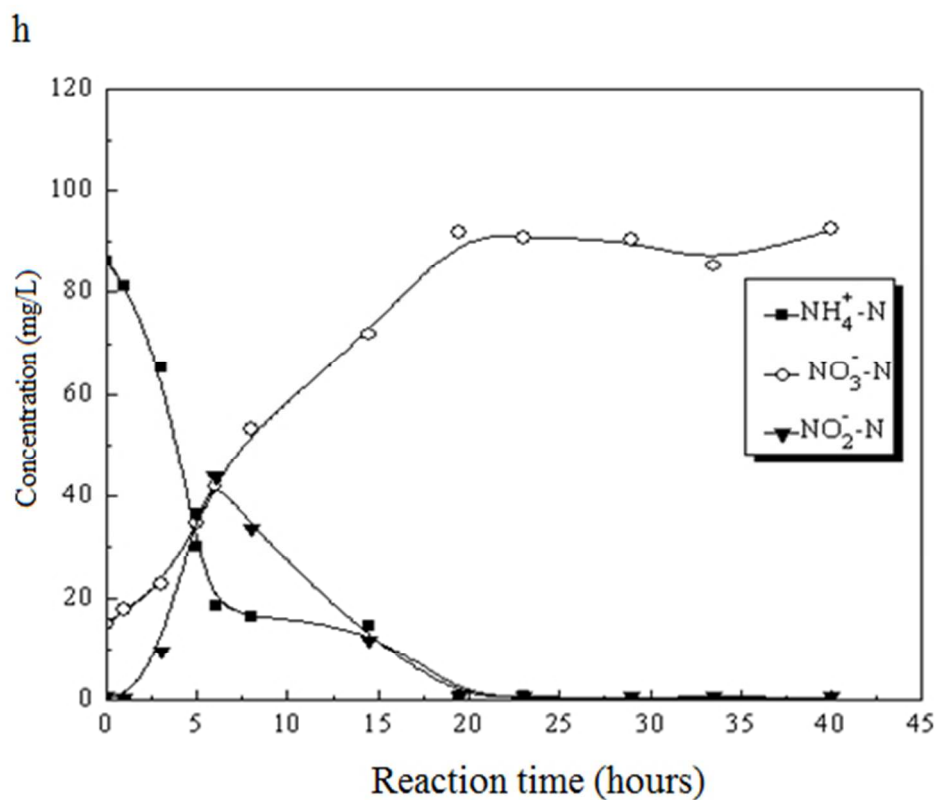

Figure 2. (a) COD degradation during anaerobic hydrolysis acidification, (b) total phenol degradation during anaerobic hydrolysis acidification, (c) volatile phenol degradation during anaerobic hydrolysis acidification, (d) Intermittent aerobic removal of COD, (e) Intermittent aerobic removal of total phenol, (f) Intermittent aerobic removal of volatile phenol, (g) Intermittent aerobic removal of Ammonia and (h) the changes in the concentration of NH_4^+-N , NO_2^--N and NO_3^--N in the aerobic SBR reactor (in the reaction stage of the 50th cycle, Anaerobic 24 h + Aerobic 48 h)
144x126mm (96 x 96 DPI)

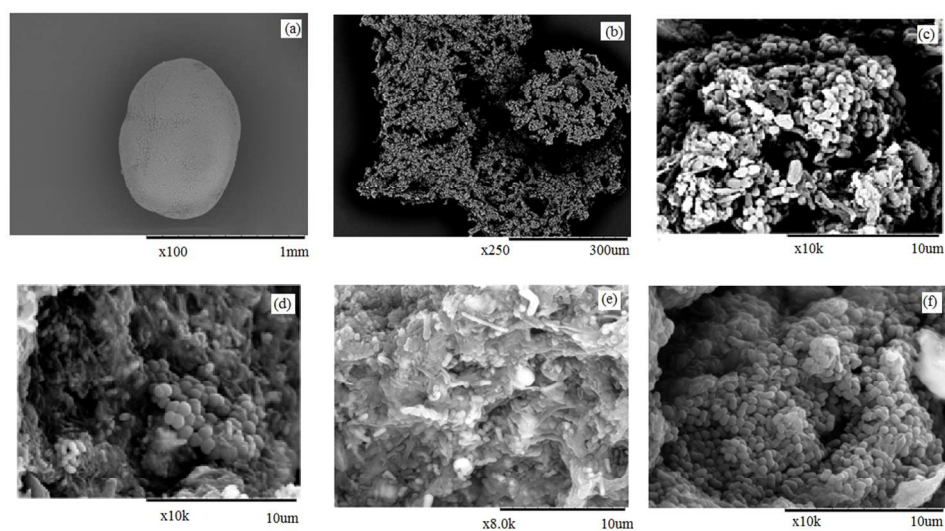

Figure 4. SEM observation of the anaerobic sludge (a) anaerobic seeding sludge, (b) 48 h during the steady operation of hydrolytic acidification sludge, (c) and (d) Flocculent sludge is dominant during 48 h steady operation of hydrolytic acidification sludge, (e) aerobic inoculation sludge, and (f) aerobic sludge after 20 cycles of domestication.
332x192mm (96 x 96 DPI)

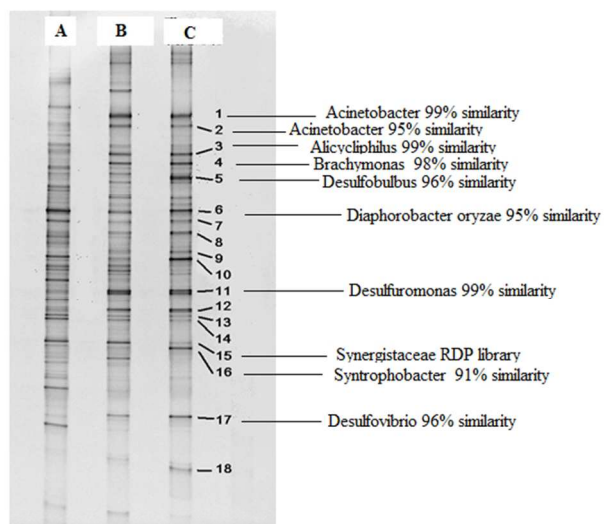

Figure 5. Profiles of PCR-DGGE analyses of the anaerobic bacterial community structures (A) inoculated sludge before domestication (as a marker), (B) sludge after domestication (20 operation cycles) , and (C) Sludge after domestication (52 operation cycles) 238x200mm (96 x 96 DPI) 238x200mm (96 x 96 DPI)

Table 1

Analysis of various organics components (similarity>80% with NIST database) in influent and effluent of each section

Classification	Organic compounds	Influents	Effluents				Classification	Organic compounds	Influents	Effluents			
			A	B	C	D				A	B	C	D
Phenol compounds	Phenol	56.78	18.20	-	10.73	0.32	Polycyclic	2- methyl-9H-fluorene	-	-	0.73	-	-
	Cyanophenol	0.17	-	-	-	-		Dibenzo-diazabicyclo	-	-	1.11	-	-
	2-Methylphenol	2.75	1.40	-	2.07	-		2-methyl-1,6- dihydroxy-9,10- anthraquinone	0.07	-	-	-	-
	3-Methylphenol	1.91	0.84	-	3.34	-		2-methylphenanthrene	-	-	-	0.12	-
	4-Methylphenol	3.86	0.89	-	-	-		1, 6-dimethyl-4-(1-methylethyl)naphthalene	-	-	-	-	0.54
	3, 5-dimethylphenol	0.04	-	-	-	-		pyrene	-	-	0.36	-	0.64
	5-amino -1-naphthol	-	-	-	0.85	-		9,10-Bis(chloromethyl)anthracene	-	-	-	-	0.56
	2,2'-biphenol	-	0.88	-	0.63	-		pentanoic acid	0.96	-	-	-	-
	2,2'-Biphenol oxide	-	-	-	0.21	-		hexanoic acid	2.12	-	-	-	-
	2,6-di-tert-butyl-4-nitrophenol	-	-	-	-	0.56		heptanoic acid	4.20	-	-	-	-
	2,6-di-tert-butyl-4-methylphenol	-	-	1.08	-	0.62		octanoic acid	2.01	-	-	-	-
	4,4'-(1-methylethylidene)bisphenol	-	0.36	1.49	0.17	-		nonanoic acid	1.28	-	-	-	-
	1-butyl-hexyl-benzene	-	-	0.52	-	0.29		decanoic acid	0.09	-	-	-	-
	(1-propylheptyl)benzene	-	-	0.77	-	-		Benzoic acid	0.55	-	-	-	-
	(1-ethyloctyl)benzene	-	-	-	-	0.33		p-propylbenzoic acid	-	0.59	-	-	-
(1-methyldecyl)benzene	-	-	2.44	-	1.29	Phenylpropionic acid	0.21	-	-	-	-		
(1-ethylnonyl)benzene	-	-	1.16	-	0.80	2 - methylbenzoic acid	0.35	1.37	-	0.45	-		
(1-propyloctyl)benzene	-	-	1.77	0.43	0.91	3 - methylbenzoic acid	2.66	5.45	-	3.21	-		
(1-butylheptyl)benzene	-	-	1.61	-	0.80	4 - methylbenzoic acid	1.19	2.03	-	1.22	-		
1-methyl undecylbenzene	-	-	1.60	-	0.95	2, 4-dimethylbenzoic acid	-	-	-	0.30	-		
(1-ethyldecyl)benzene	-	-	1.22	-	0.77	2, 5-dimethylbenzoic acid	0.09	0.96	-	0.58	-		
(1-propylnonyl)benzene	-	-	1.61	0.32	0.83	2, 6-dimethylbenzoic acid	-	0.37	-	-	-		
(1-butyloctyl)benzene	-	-	1.42	-	0.83	3,4-dimethylbenzoic acid	2.21	-	-	1.93	-		
(1-pentylheptyl)benzene	-	-	1.28	-	0.61	3,5-dimethylbenzoic acid	0.22	6.36	-	-	-		
(1-ethylundecyl)benzene	-	-	0.61	0.16	0.58	Cyclopentanecarboxylic acid	0.08	-	-	-	-		
(1-propyldecyl)benzene	-	-	1.14	-	0.99	2-Methyl-4-pentenoic acid	0.08	-	-	-	-		
(1-butylnonyl)benzene	-	-	0.83	-	0.57	3-Methylpentanoic acid	-	0.13	-	-	-		
(1-pentylloctyl)benzene	-	-	1.38	-	0.93	3-Methylhexanoic acid	0.19	-	-	-	-		
Decylcyclopentane	-	-	0.58	-	-	4-Methylpentanoic acid	0.26	-	-	-	-		
Hexadecane	0.11	-	1.11	-	0.54	cyclohexanecarboxylic acid	0.94	-	-	-	-		
Undecylcyclopentane	-	-	ND	-	0.37	Cyclohexylacetic acid	-	0.41	-	-	-		
Heptadecane	0.17	-	1.49	-	0.40	2-Naphthoic acid	0.31	0.98	-	-	-		
Octadecane	0.52	-	0.84	0.57	0.46	hexadecanoic acid	0.14	0.67	0.56	0.24	0.60		
Nonadecane	0.02	-	2.08	-	0.47	octadecanoic acid	0.11	0.15	-	-	-		
Eicosane	0.13	0.18	-	0.06	0.71	2-cyclopenten-1-one	0.08	-	-	-	-		
2,6,10,14-tetramethylhexadecane	0.09	0.12	-	-	-	Cyclopentanone	0.22	-	-	-	-		

	heneicosane	-	0.34	1.13	0.38	1.26		2-Methyl-2-cyclopenten-1-one	0.44	-	-	-	-
	docosane	-	-	-	-	0.42		3,4-dimethyl-2-Cyclopenten-1-one	0.09	-	-	0.62	-
	Tricosane	-	-	-	-	2.58		4,4-dimethyl-2-Cyclopenten-1-one	0.29	0.24	-	-	-
	Tetracosane	1.53	0.48	3.49	0.41	11.1		3-ethyl-2-cyclopenten-1-one	0.16	-	-	-	-
	Pentacosane	0.24	0.11	-	0.24	-		2,3-dimethyl-2-Cyclopenten-1-one	0.59	0.52	-	0.78	-
	Heneicosylcyclopentane	-	-	-	-	0.68	Ketone	Phthalimidine	0.78	-	-	-	-
	Hexacosane	0.28	-	1.99	-	-		3-Hydroxyacetophenone	0.26	-	-	-	-
	3-ethyltetracosane	-	-	-	-	0.27		4-Hydroxyacetophenone	0.43	-	-	-	-
	heptacosane	0.03	-	-	-	0.56		2'-Hydroxypropiophenone	0.08	-	-	-	-
	cyclooctacosane	-	-	-	-	0.62		4-Hydroxy-3-methylacetophenone	0.13	1.75	-	0.69	-
	octacosane	-	-	1.17	-	-		mono-methyl phthalate	-	-	-	0.57	0.14
	2 - methyl octacosane	0.11	-	-	-	-		dibutyl phthalate	0.01	1.93	0.49	1.98	1.16
	Triacontane	-	-	-	0.09	-		bis(2-methylethyl) phthalate	-	-	-	-	1.47
	dotriacontane	0.22	-	-	-	-		(isobutyl-3-vinyl) phthalate	-	1.89	-	2.04	-
	Octamethylcyclotetrasiloxane	-	-	1.16	-	-		2,6-dimethylphenyl isocyanate	0.15	-	-	-	-
	Decamethylcyclopentasiloxane	-	0.51	3.07	0.61	0.82	Esters	Ethyl Palmitate	-	0.33	-	0.05	0.43
	Dodecamethylcyclohexasiloxane	0.23	1.19	4.49	0.89	1.67		Hexadecanoic acid hexadecyl ester	-	0.03	-	0.09	-
	octadecamethylcyclononasiloxane	-	0.79	5.50	1.31	2.83		Hexadecanoic acid, octadecyl ester	-	-	-	0.23	-
	Tetradecamethylcycloheptasiloxane	0.05	1.74	3.44	1.47	1.44		3,5-bis(1,1-dimethylethyl)-4-hydroxyl-Phenylpropanoic acid octadecyl ester	-	0.06	0.96	-	0.21
	3, 4 - dimethyl - 2, 5 - furandione	0.10	-	-	-	-		Benzamide	0.12	-	-	-	-
	2-Acetylpyrrole	0.02	-	-	-	-		phthalimide	-	-	-	-	0.26
Heterocyclic	1,5-Dimethyl-pyrrolidinone	0.08	-	-	0.39	-		3-acetanilide	0.08	-	-	-	-
	phthalimidine	0.78	-	-	1.62	-	Amines	N-isopropyl-N'-phenyl-1,4-phenylenediamine	-	0.07	1.54	0.10	1.08
	2(1H)-quinolinone	1.43	-	-	3.04	-		Hexadecanamide	-	-	-	-	0.93
	5-quinolinol	-	1.76	-	-	-		(Z)-9-Octadecenamide	-	0.10	1.32	0.14	2.01
	1,2-dihydro-2,2,4-trimethylquinoline	-	-	0.25	-	0.09		Stearamide	-	0.04	-	-	-
	5-acetyl-2-methylpyridine	0.10	-	-	-	-		Erucamide	-	0.07	0.55	-	-
	1-methyl-2-pyrrolidinone	0.02	-	-	-	-		2-hydroxy-3-pentene	0.26	-	-	-	-
	3-hydroxy-6-methylpyridine	0.06	-	-	-	-		8-heptadecene	-	-	0.38	-	-
	6-methyl-2-(2,3-dimethyl-2-butyl)-dimethylsiloxy-pyridine	0.05	-	-	-	-	Alkenes	1-Octadecene	-	-	-	-	0.47
	1-methylnaphthalene	-	-	-	-	0.05		Benzocyclopentene ,4,6,7- triethyl-1-methyl-5-vinyl triacontahexaene	1.04	2.01	-	-	-
	1,7-Dimethylnaphthalene	-	-	-	0.92	-		2-methyl-p-phthalaldehyde	-	-	-	0.76	-
	2,3-Dimethylnaphthalene	-	-	-	-	0.13	Aldehyde	3,5-Di-tert-butyl-p-hydroxybenzaldehyde	-	-	0.55	-	0.80
	2,7-Dimethylnaphthalene	-	-	-	-	0.09		Benzyl alcohol	-	-	-	-	0.37
Polycyclic	Fluorene	-	-	0.82	-	-	Alcohols	Cedrol	-	-	-	-	0.34
	phenanthrene	-	-	-	-	0.81		phthalic anhydride	-	2.36	-	-	-
	9-methylene-9H-fluorene	0.03	-	-	-	-	Anhydride	oleic nitrile	-	-	-	-	0.33
	1-methyl-9H-fluorene	-	-	-	-	0.48	Nitriles						

a. Values represent the relative percentage of total peak area; b. “-” not detected; c. Identification of organics by the NIST database.

Table 2

Normalization analysis of organics in influent and effluent of each section (similarity>80% with NIST database)

Organics	Influent	Effluents			
		A	B	C	D
Phenols	65.51	22.57	2.57	18	1.5
Benzene	ND	ND	19.36	0.91	11.48
Carboxylic acids	20.25	19.47	0.56	7.93	0.6
Heterocyclic	2.92	5.99	17.91	9.33	6.85
Polycyclic	0.1	ND	3.02	1.04	3.31
Ketones	3.55	2.51	ND	2.09	ND
Alkanes	3.45	1.23	13.88	1.75	20.44
Lipids	0.16	4.24	1.45	4.96	3.41
Olefins	1.3	2.01	0.76	0.05	0.83
Amines	0.2	0.28	3.41	0.24	4.28
Total	97.44	58.3	62.92	46.3	52.7

*the data in table is the percentage of organics peak area in relation to total area of peak (%); "ND", not detected; A, anaerobic 24h effluent; B, anaerobic 24h+aerobic 48h effluent; C, anaerobic 48h effluent; D, anaerobic 48h+aerobic 48h effluent.

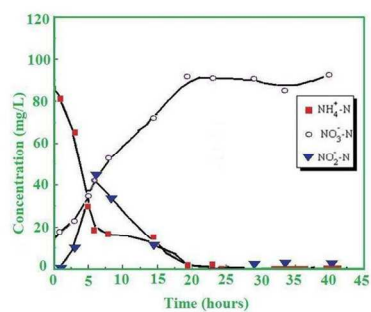

Graphical Abstract
517x168mm (96 x 96 DPI)