

Cite this: *RSC Sustainability*, 2024, 2, 1014

Counterfactual sustainability screening – the definition and undertaking of a sustainability screening method for the assessment of defossilised supply chains†

Edward G. Platt  and Peter Styring*

With the monumental shift in industrial interest towards sustainable, defossilised supply chains in response to the climate crisis, the understanding of alternative supply chain viability has never been more vital. As part of their Clean Future initiative, Unilever Home Care has committed to the phasing out of fossil carbon sources from their supply chains. To better assess the viability of these prospective supply chains within a quick timeframe, a counterfactual screening method has been developed which pits the performance of eleven selected sustainability indicators against a success baseline, returning a results array on the sustainability performance of these routes. This paper briefly introduces the initiatives laid out by Unilever Home Care, before undertaking a concise review on existing sustainability screening methods from the literature, with the key limitations of these methods outlined. In response to these limitations, a new methodology is then defined, with a case study of defossilised Linear Alkylbenzene Sulfonate (LAS)-appropriate olefins being applied. This study both illustrates the functionality of the methodology, as well as provides an insight into the viability of the assessed supply chains. Within the study, 18 technologies forming 18 routes were assessed, spanning green (“from plants”), grey (“from plastic waste”) and purple (“from CO₂”) feedstocks (according to the carbon rainbow). General results trends suggest that green and grey routes hold much greater viability than the purple routes, given their relatively lower capital and operating costs, as well as their superior likelihood of being commercially viable by 2030. Plans for further research are also provided, with plans for results validation included.

Received 9th August 2023
Accepted 15th January 2024

DOI: 10.1039/d3su00272a

rsc.li/rscsus

Sustainability spotlight

In order to move towards sustainable, defossilised supply chains, it is vital for stakeholders and decision-makers to hold an understanding of a process' viability before investing in its development. This research investigates the potential for a sustainability screening method to gain a quick and early understanding of a process' sustainability potential before the application of industrially standard practices, such as life cycle assessment (LCA) and techno-economic assessment (TEA). As a framework, the application of a variety of sustainability indicators can be adopted. In the case study applied, specific indicators draw from sustainably sourced raw materials (SDGs 9 & 12), impacts of supply chains on ecosystems (SDGs 14 & 15), as well as indicators focussing on climate change (SDG 13).

1 Introduction

As a response to the ever-growing climate crisis which threatens almost every part of modern-day society, companies are turning their efforts towards more climate-friendly supply chains. With the signing of the Paris Agreement in 2016, substantial efforts are required by both nations and corporations to mitigate the effects of climate change.¹ As a result, the extensive pool of technologies that promise a utility of renewable or defossilised

feedstocks is ever-growing, with new defossilised technologies making their way towards market every year.²

One such company whose recent climate targets highlight this shift in attitude is Unilever Home Care, whose Clean Future initiative outlines targets to defossilise all their supply chains (as seen in the carbon rainbow, Fig. 1) and achieve net zero carbon emissions from cradle to shelf from 2039.³ These initiatives fall in line with the push for sustainable supply chains within the wider FMCG and cleaning industry, the need for which is highlighted by bodies such as the International Association for Soaps, Detergents and Maintenance Products (AISE) and their Charter for Sustainable Cleaning.⁴

As companies like Unilever look to the future of their supply chains and aim to broaden their sphere of knowledge with respect to defossilised supply chains, having an early

UK Centre for Carbon Dioxide Utilisation, Department of Chemical & Biological Engineering, The University of Sheffield, Sheffield, UK. E-mail: p.styring@sheffield.ac.uk

† Electronic supplementary information (ESI) available. See DOI: <https://doi.org/10.1039/d3su00272a>



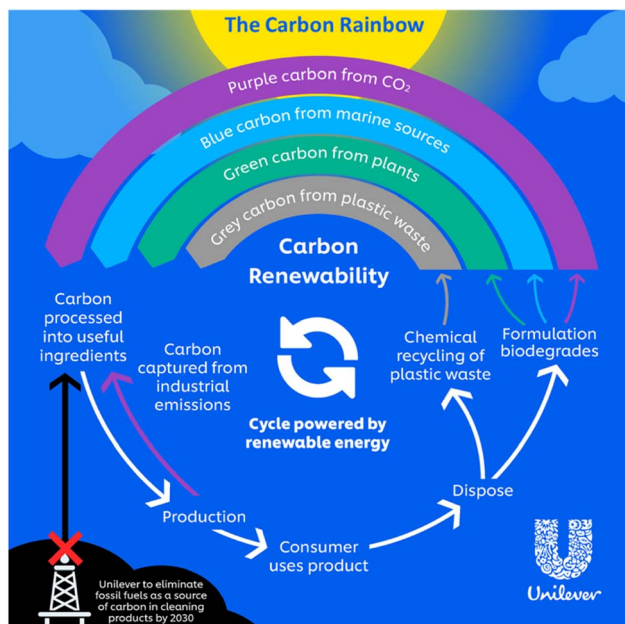

Fig. 1 The carbon rainbow.¹

understanding of the viability of potentially beneficial technologies both market ready and in development is paramount to achieving such climate goals. In such a case where a viability check for a large quantity of prospective supply chains is necessary, undertaking informative life cycle and techno-economic assessments for each technology is a challenging task. These assessments also potentially hold large data requirements for technologies that may not even have inventory data for a fully scaled plant (and therefore considerable uncertainty). As a result, efforts towards a pre-LCA/TEA screening assessment have picked up in recent years, not with the intention of making final decisions, but acting to provide red or green flags for a defossilised process' viability, with their necessity already well-documented within the open literature.⁵

This paper reports research which investigates how these screening assessments have been approached in the past, and outlines a new type of counterfactual sustainability screening, looking to address some of the current pitfalls with existing methods.

2 Current methods and limitations of sustainability screening assessments

2.1 Existing circular supply chain screening methodologies

With regards to other sustainability screening studies, a considerable amount of effort has focussed on outlining the need for, and the development of, screening assessment methods. These generally look at different ways of providing evidence for decision-makers, using data from a variety of sources and associated process characteristics, but with the common goal of making relatively quick assessments for new technological alternatives to conventional linear feedstocks. To best understand these methodologies, build on their

limitations and build on existing research, a comprehensive review of recent publications (within the last 5 years) has been undertaken.

One such study, used to screen different Carbon Capture and Utilisation (CCU)-derived intermediates (hereby referred to as “the CCU study”), looked to score technological performance across nine indicators on a scale of 0–4.⁶ These scores were then weighted based on indicator priority, before being summated to give an overall sustainability score. The scores were assigned and cross-checked by a team of sustainability experts, using a defined scoring guide provided by the study, which looked to score indicator performance based on absolute performance. Despite the CCU study providing an informative insight into these platform chemical alternatives, the issues surrounding data quality and uncertainty proved to be limiting.⁶ This, alongside a sensitivity analysis undertaken to assess to what level the assessment is affected by practitioner bias, further showcases the limitations of using discrete, ex-ante data for decision-making.

Drawing inspiration from the CCU study, a similar study was used to assess defossilised routes to benzene,⁷ again using a scoring guide which looks to assign scores based on definite yet uncertain data against a practitioner-assigned scale. Again, this reliance on uncertain data means that, whilst still suitable for a screening according to the author,⁷ conclusions must be taken with a pinch of salt.

Studies performed and published by Kravchenko at DTU must also be acknowledged here.⁸ From this work, the need for a concise screening assessment, particularly for applications to circular economy (CE) technologies, is vast, particularly those based on forecasted sustainability impacts. These also go a long way towards defining methods for indicator selection, a key part of all sustainability assessment.

Overall, these studies provide an excellent motivation and justification for the development of sustainability screening as a decision-making aid, as well as some of the key issues with impact-centric assessments and the issues arising when assigning scores with limited data.

2.2 Multi-criteria decision making (MCDM) applications to supply chains

Within the broader field of sustainability assessment, aside from screening, research into the implication of multi-criteria decision making (MCDM) has proven highly influential, with the capability of aggregating data under uncertainty to aid decision-makers. Within the methods outlined in Section 2.1, elements of MCDM relate heavily between the methodologies, with techniques such as the analytic hierarchy process (AHP)⁹ and the technique for order of preference by similarity to ideal solution (TOPSIS)¹⁰ are both utilised by the screening assessments outlined in Section 2.1.

The literature surrounding methods of this nature and application extensive. In reviewing the literature surrounding these methods, it can be seen that these methodologies are primarily used to aid in decision-making utilising absolute data for prospective supply chains. In a recent review of the literature



published by Mastrocinque *et al.*¹¹ a review of 30 different literature contributions highlights how MCDM practices have been applied to sustainable energy sources for supply chain application. In reviewing literature sources tailored to photovoltaic energy sector, three-quarters of the indicator inputs across the reviewed studies required discrete data, without in-depth comment or assessment of uncertainty. Within many applications, such as those covered in Section 2.1, access to reliable, discrete data for supply chain viability assessment is not possible under the constraints held by open literature.

A further literature review published as a book chapter by Khan *et al.* outlined and summarised over 140 different applications of multi-criteria decision analysis to supply chain management.¹² In consulting the literature, the difficulties of MCDM implementation due to data availability are highlighted as a key restraining factor when it comes to supply chain applications. This ultimately highlights the issues of using MCDM as making a final decision for many stakeholders and researchers, whereas the utilisation of a screening methodology withdrawn from the need for discrete data (or absolute impact prediction) can, in theory, help address the issues of data availability surrounding MCDM. The study furthers this point by highlighting a key opportunity with respect to future work is the aiding in the increase in data availability. Given the conclusions drawn from the review published by Platt and Styring,² the issues of process data limitation are still a significant issue within the application of LAS-appropriate olefins, compromising the potential for a reliable assessment akin to those highlighted within the literature reviews cited.

2.3 Addressing these limitations

In looking to address these issues of data quality and availability, inspiration was taken from other methodologies which make informed decisions based on indiscrete data. Conventional occupational and environmental risk assessments look to make decisions as to whether a practice is inherently safe for those undertaking it, not through the accurate or specific prediction of a process' performance, but instead the likelihood that an impact (such as toxic material exposure) exceeds a set baseline. This mentality when assigning scores, theoretically, gives operators the opportunity to assess a process' performance without the need for accurate data, instead assigning a risk value on how likely the performance value is to exceed a defined baseline.

Consider the sustainability indicator of capital expenditure (the usually one-time cost associated with bringing a plant to an operable state). Estimating a definite capital expenditure based on ex-ante data and then scoring on a scale carries a large element of uncertainty, as well as the potential for operator bias.¹³ Instead, the concept of assigning a likelihood that the capital expenditure exceeds a defined value (for example, based on project funding) provides a different scenario for the assessment operator to base decisions on.

"It is not usually possible to accurately predict the levels of environmental effects caused by human actions. However, even without predicting absolute magnitudes of effects, application

of the concept of risk can lead to substantial improvements in environmental assessment and protection."¹³

This quote provides an accurate description of the methodology proposed, instead application to broader sustainability metrics is used, as opposed to "environmental effects" and the "human actions" in question are the deployment of a prospective technology or supply chain.

2.4 Research aims

Building on these ideas and review of the literature, this research looks to outline an alternative sustainability screening methodology to those in the literature, with the basis of assessment lying in predicting whether indicator performance exceeds a pre-determined success baseline. This to address the difficulties in predicting absolute impact magnitudes within a given future scenario and allowing for assessment based on both quantitative and qualitative characteristics of prospective processes and supply chains.

The target audience for this research is operators with relative understanding of sustainability assessment processes, capable of effectively utilising knowledge of new and existing processes to aid in the broader decision-making process. The methodology also aids operators and stakeholders in forming a bank of evidence which can be updated as and when process-relevant information is made available or published. This addresses the aforementioned drive for stakeholders to expand their sphere of knowledge surrounding sustainable supply chains.

The methodology is to be outlined alongside an application to defossilised olefins for application to linear alkylbenzene sulfonate (LAS)-appropriate olefins to illustrate how an assessment is undertaken. The results of the study are also presented in-line with a broader study into defossilised olefins within the scope of the Clean Future and Carbon Rainbow initiatives.

3 Methods

The method outlined for the screening of process sustainability is split across four key steps, followed by results interpretation, with the overall aim to assess each route within a determined network of processes leading to a common product. This section provides an overview of each stage and, for illustrative purposes, the application to the network considering defossilised surfactant-appropriate olefins outlined by Platt & Styring.² The results of the final supply chain assessments then provide the basis of further assessment or justified disregard for future study due to poor performance or viability. The finished screening is to then act as a living document, with the idea of updating given scores as technologies mature and to essentially provide an evolving viability scorecard whilst data certainty improves.

3.1 Goal and scope definition

Akin to a typical LCA and TEA, the first stage of the methodology is to understand the goal of the assessment and the scope at which the assessment is to take place. The goal of this



assessment is to compare the viability of a network of defossilised supply chains for the formulation of Linear Alkylbenzene Sulfonate (LAS)-appropriate olefins. These consist of α -olefins of carbon chain length 10 to 14, in line with the product description given by Meyers in the Handbook of Petroleum Refining Processes.¹⁴ A previous study by Platt & Styring² sought to outline and review literature surrounding potential defossilised technologies which can provide routes to these olefins, which are assessed as part of this study. Fig. 3 outlines these technologies, labelled T1 to T18. This assessment will cover a variety of indicators selected in line with Unilever (the stakeholder)'s climate goals, outlined in Section 1. A summary table describing each technology is provided in the ESI (Section S3.1†).

The decision to study these olefins is motivated considerably by the prevalence of LAS within the cleaning industry, acting as one of the key ingredients in many cleaning products,¹⁵ justifying the requirement for sustainable production in order to address the Paris Agreement and AISE charters.

The aim of this assessment, being that of a screening, the final results will not necessarily be to act as a final decision, more provide conclusions and trends which will help in planning future sustainability research efforts. Key takeaways will be drawn with respect to feedstock category (with respect to those outlined in Fig. 1) and specific indicator performances to be accounted for when making future decisions.

With regards to scope, in accordance with the Greenhouse Gas Protocol, all scope 3 emissions will be accounted for from supply chain cradle to gate.¹⁶ These include emissions associated with all direct and indirect processes associated with the production of the product, as well as those associated with the generation of purchased energy and all upstream processes. This is selected to ensure the assessment is completed in line with Unilever's Clean Future targets.³ The requirement for an assessment for the entire supply chain and is driven by the fact that many feedstock-handling processes result in the production of platform chemicals which differ from the current LAS-appropriate olefin supply chain.¹ As a result, the processes required to process these alternate platform chemicals also require screening, even if these processes are well developed and utilised within other supply chains. With the scope defined above, the sourcing of materials and the impacts associated are also to be accounted for, including transportation. In addition to the production and material sourcing contributions, the emissions associated with product degradation were also included, to differentiate between cases in which biogenic and non-biogenic carbon was introduced or reintroduced to the atmosphere. This is due to avoided emissions not being accounted for in accordance with the Science Based Targets initiative.¹⁷ Fig. 4 is presented to better illustrate the scope adopted.

As mentioned in Fig. 2, it is also vital to set informed future scenario assumptions to ensure informed conclusions are drawn. Within this assessment, a timeframe of 2030 was set, in line with the Clean Future initiative, with operation to be held within Germany, a location selected based on its wide, yet representative infrastructural offerings, as well as the fact that Chemische Fabrik Wibarco of Ibbiburen, Germany, currently

produces 66 000 tonnes of LAS per year.¹⁵ This site was deemed appropriate due to its average scale. Further assumptions, in accordance with the Bavarian Industry Association, hold energy prices at a predicted €84 per MW h, produced by 80% renewable sources.¹⁸ These figures were deemed appropriate due to the fact they considered the volatile effects on energy prices due to the COVID-19 pandemic and the ongoing Russo-Ukrainian war.

3.2 Indicator selection

In order to assess the proposed supply chain routes, eleven sustainability performance indicators were drafted, each with the aim of considering any combination of the economic, environmental, and social sustainability of the assessed technology. Each indicator was selected in accordance with one of either Unilever's Clean Future initiative,³ the United Nation's Sustainability Development Goals (UN SDGs),¹⁹ or from a recent and extensive review of the sustainability assessment literature, and the most used sustainability assessment indicators within the chemical industry.²⁰

3.2.1 Indicator 1: capital expenditure (CAPEX). Defined as the fixed, one-time expense which covers the land acquisition and complete plant purchasing or construction. The total cost needed to bring a process or supply chain to commercially operable status. The CAPEX of a technology is objectively a key driver behind the economic sustainability of a technology. It is vital that the cost of the final product remains competitive within a mixed market of fossil-based and defossilised derivations, which includes a competitive CAPEX to ensure reasonable process lifetime costs. This selection is also justified within the literature review,²⁰ whilst also falling under Goal 8 of the UN SDGs.¹⁹

3.2.2 Indicator 2: material operating costs (material OPEX). Complementing the economic assessment of indicator 1, maintaining an economically competitive practice is key to the overall sustainability of a technology or supply chain. The material OPEX concerns the operating costs associated with the procurement of key reactants, intermediates, catalysts, and any other physical commodity required by the defossilised technology. With a wide variety of feedstocks considered within the assessed network,² the material OPEX holds the potential to hold a wide range between technologies and therefore potentially hold great sensitivity when comparing final supply chains. Equal to the justification of indicator 1, de Faria *et al.*²⁰ listed material OPEX (or "processing costs") as one of the key sustainability indicators from a review of the literature, and again the concerns of financial sustainability are covered by Goal 8 of the UN SDGs.¹⁹

3.2.3 Indicator 3: added sustainability value through process symbiosis. Deviating slightly from the conventional indicators listed previously, indicator 3 looks to credit process sustainability due to a utilisation of a parallel process' by-products. This practice looks to lower the risk of feedstock/reactant supply risk, especially if the parallel process can be defined as integral to society (such as the cement, steel, and agricultural industries). This provides both the economic benefit of a low-risk supply chain and generally cheaper-to-



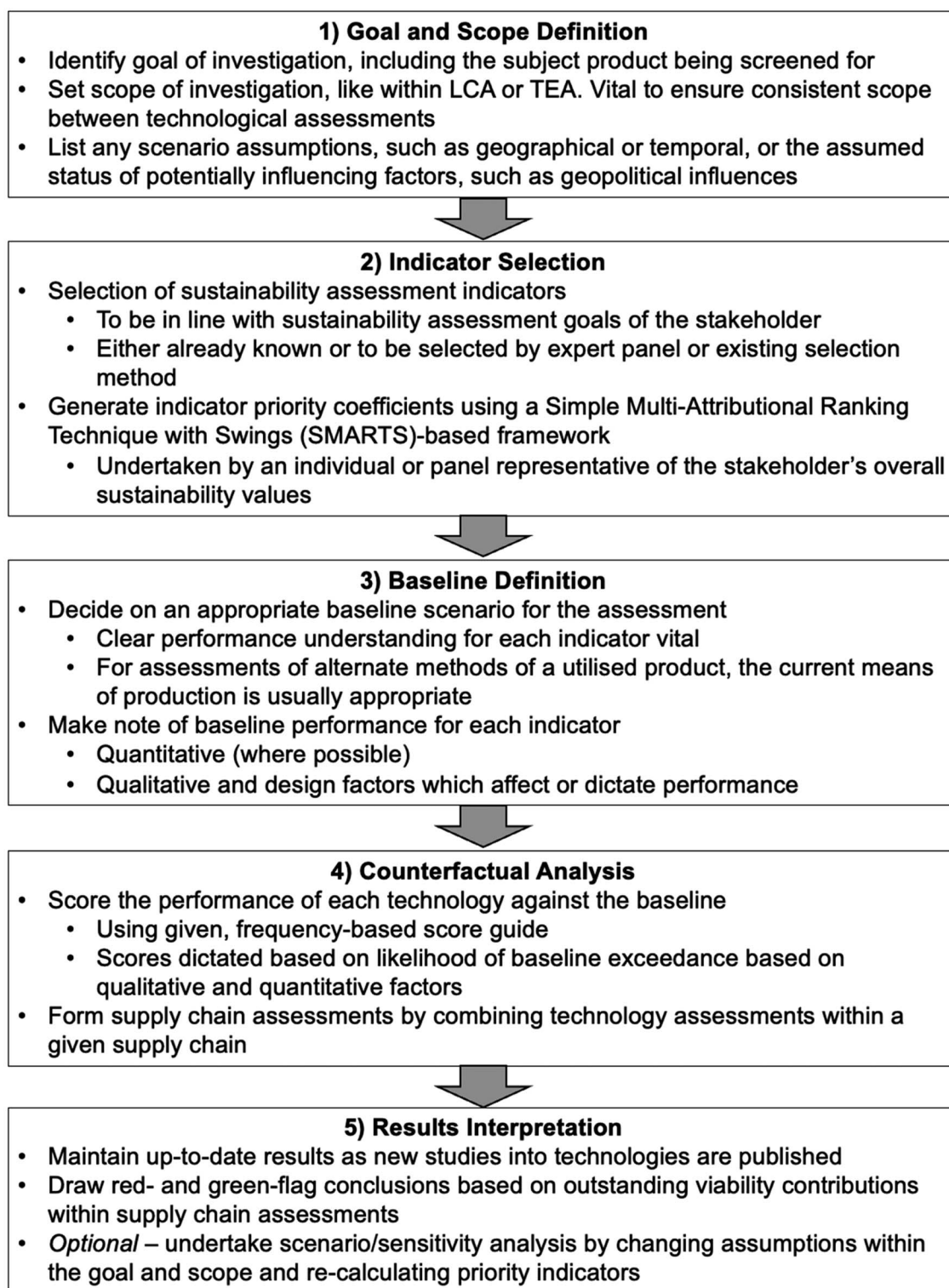

Fig. 2 Sustainability screening methodology framework.

produce materials, and the environmental benefit of by-product utilisation and greater supply chain circularity and the overall benefits of such practices.²¹ This indicator was drafted following extensive communications between industrial and academic researchers involved within the project and provides vital

information on a technology's adherence to the Clean Future targets.³

3.2.4 Indicator 4: technology readiness level (TRL). With the Clean Future initiative targets holding temporal limits, it is integral that assessed technologies are operational at



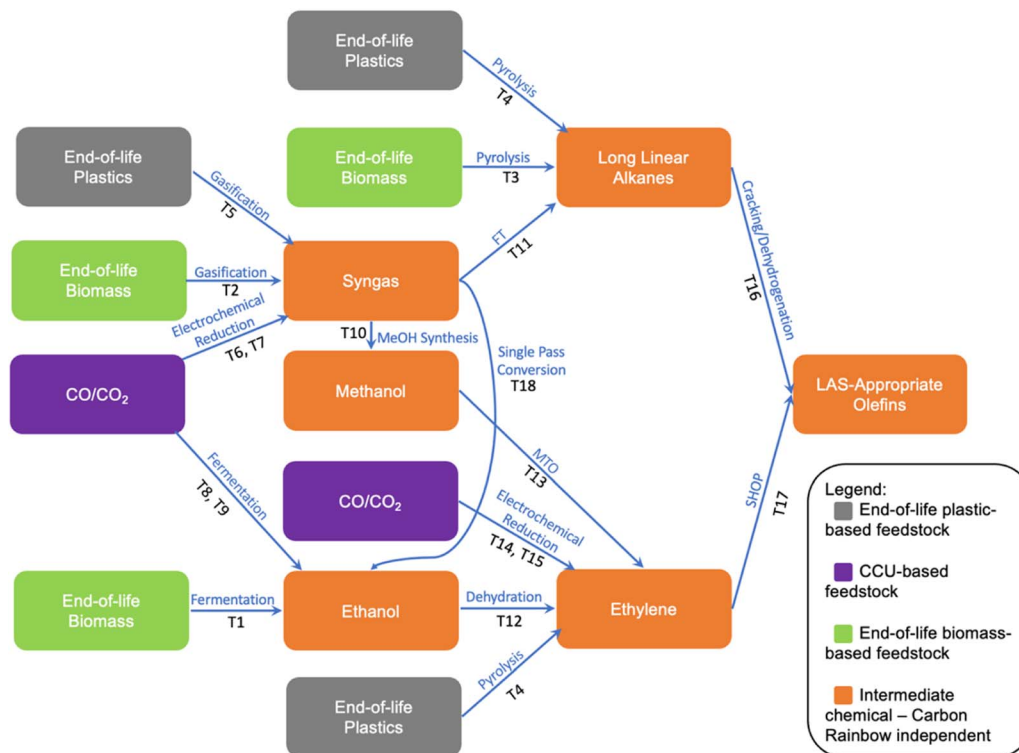

Fig. 3 Defossilised routes to LAS-appropriate olefins (edited from Platt and Styring).² Number labels have been added for future reference.

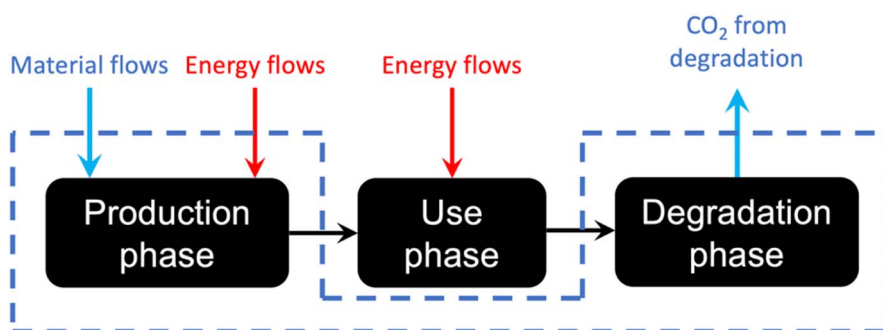

Fig. 4 Assessment scope.

a commercial scale and operating within their respective markets within said timeframe. With a supply chain defossilisation target timeframe of 2030, understanding the current TRL and forecast rate of development of the prospective technologies is paramount, as well as the consequential likelihood that said technologies will be market-ready by that year. Ultimately the process in question must be of TRL 9 for the market readiness level to also be of an appropriate order, and therefore the baseline score is 9. TRL 4 is renowned for being where most technologies either sink or swim, with most developmental failures occurring at this stage.²² Technologies after this stage hold a much larger probability of commercialisation by the target year of 2030.

3.2.5 Indicator 5: use of renewables in feedstocks. An environmental-centric indicator, the use of renewables in

feedstocks, especially with regards to the net zero by 2039 target within the Clean Future initiative, is of high importance and paramount to the assessment. Under current carbon accounting rules, as previously outlined, the accounting of avoided emissions cannot be undertaken.¹⁷ This therefore means that only “renewable” materials (based on biogenic carbon sources, such as DAC-sourced CCU and end-of-life biomass) can be counted as a “negative in-flow” of carbon dioxide (or avoided accountability of the final degraded product).²³ As a result, the final global warming potential (GWP), and overall environmental performance of a given technology or feedstock could well be largely influenced by the renewability of the feedstock.

A further point of interest with respect to indicator 5 is the how this renewability is affected by the production and transportation methods of the feedstocks. If the carbon embedded



within the feedstock is renewable but there are non-renewable elements to the manufacturing or handling processes involved, these effects are to be represented within this scoring.

3.2.6 Indicator 6: arable land use. The reliance on arable land holds great influence with regards to process sustainability with respect to the environmental, economic, and social pillars of sustainability.²⁴ Whilst technologies which utilise primary biomass as a feedstock falls out of scope of this assessment (as a means of avoiding the food *versus* fuel debate), feedstocks and materials still hold land use values. As arable land is used and soil degraded, adverse soil impacts and supply chain threats hold the potential to negatively impact process sustainability. The selection of this indicator is also justified by the literature review (with respect to soil degradation)²⁰ and the UN SDGs, with Goal 15 holding the greatest emphasis on sustainable use of arable land.¹⁹

3.2.7 Indicator 7: ecosystem depletion. This indicator concerns the overall material balance with the local ecosystem, both within wastes and emissions, the impact of these flows, and the impacts of abiotic material reliance. From the perspective of an LCA, this indicator is largely broken down into several, smaller indicators, such as eutrophication, acidification, and ozone depletion, such as within the ISO 14044 standards on life cycle assessment.²⁵ Whilst the Clean Future initiative prioritises the reduction in lifetime carbon emissions through adopting new supply chains, it is vital that other forms of environmental and ecosystem detriment are not accelerated consequently.²⁶ This indicator also holds a degree of economic influence too, encompassing impacts associated with the value of materials to other supply chains. For example, the use of end-of-life biomass within a defossilised olefin supply chain may lead to a depletion of end-of-life biomass feedstocks for the agricultural industry. This reliance results in farmers will have to source alternatives for fertiliser or animal feed, both of which are current uses of end-of-life biomass, which could be detrimental to local economic affairs.

3.2.8 Indicator 8: overhead operating costs (overhead OPEX). Overhead OPEX investigates costs associated with non-material means. This may include the need for specialist waste management techniques or safety systems due to extreme process conditions. Generally speaking, processes with these requirements hold greater operating costs, due to the maintenance of specialist equipment and training/employment of specialist labour or plant. Justification for the assessment of overhead OPEX is comparable to those found in other economic indicators, such as indicators 1 and 2, and is also referred to as a key performance indicator by the literature review (as “waste costs” and “operational performance”).²⁰

3.2.9 Indicator 9: energy demand. The demand of energy holds influence of environmental, economic, and social sustainability.⁶ With a scope of study defined as Scope 3 by the Greenhouse Gas Protocol,¹⁶ the environmental effects associated with energy generation must be included within the study. Despite the assumption that 80% of grid electricity is renewable,¹⁸ the environmental burden for particularly high-energy processes can still be significant in a process' performance. The energy demand indicator also concerns heat energy, of which renewable sources are often harder to source without the

adoption of combined heat and power (CHP) processes and their associated high capital and overhead operating costs.²⁷

3.2.10 Indicator 10: social impacts. Likely the broadest of the indicators, indicator 10 provides the ability for the assessment operator to flag any outstanding social impacts associated with potential technologies. Whilst Unilever currently operates under a Responsible Partner Policy, in which a minimum-requirement for social performance is set,²⁸ there is still potential that processes can hold significant social impacts not covered by this policy. Comparable to the “community” indicator outlined within the Social, Health and Safety bracket of the literature review,²⁰ as well as numerous goals within the UN SDGs,¹⁹ the assessment and consideration of social impacts within this sustainability assessment is vital.

3.2.11 Indicator 11: supply chain risk. The final indicator concerns risk to supply, specifically for materials and energy, addressing the possibility of supply chain curtailment as a result of internal or external influences. The issues of supply chain security are well documented within all commercial supply chains, and monitoring is integral for businesses and industries to maintain efficient production. Within the assessment, risk of supply security can be assessed based on the relative availability of materials associated with production, for example a need for precious metals for catalyst, or any inherently seasonal or geopolitical influences on any upstream processes. Generally speaking, movement towards a circular material economy and multifaceted renewable energy grid, the outside influences on supply chain security are likely to fall. Circular material economies inherently shorten supply chains, reducing their relative target size for compromise.²¹ The same is likely to occur with energy, with a diverse electricity grid allowing for dynamic production based on weather conditions or material availability, for example.²⁹ Despite this, supply chain security can vary between scenarios.

3.3 Determination of indicator weighting values

3.3.1 SMARTS/SWING priority survey. Within the development of the screening framework, the opportunity for stakeholders to scale the sustainability scores for each individual indicator allows for augmented stakeholder specificity and resulting result relevancy. Through different companies, or even projects within the same company, the idea of specific priorities and trade-offs is ubiquitous. However, these are often difficult to quantify, especially when the scenarios presented are several years in the future. Nonetheless the quantification of these priorities is vital and common within the sustainability assessment sector.

This framework utilises a panel weighting approach, deriving from the Simple Multi-Attribute Ranking Technique with Swings (SMARTS/SWING) approach developed by Edwards and Barron.³⁰ Here, practitioners within a panel are presented with the chosen indicators and the hypothetical scenario that a process exists where performance of all 11 indicators is as low as can be reasonably expected within industry (for example a process which reaches the upper limits of company budget, utilises completely non-renewable feedstocks, a high-yet-conceivable energy demand *etc.*), and then asked which indicator they would choose to fully optimise first. It is worth noting



that the scenario assumptions outlined in Section 3.1 were also given. This optimisation would be to a level which, again, could be reasonably practiced within industry (utilises fully renewable feedstocks, holds an investment value well within budget, can be classed as autothermal, *etc.*). This first indicator is given an importance score of 100. The practitioner is then prompted with selecting the next most important indicator to optimise, giving an importance score equal to or less than the previously given score, until all indicators have a given score. The final weightings can then be derived by the use of eqn (1).

$$a_{ij} = \frac{a_i}{\sum_{a=1}^n a_n} \quad (1)$$

An in-depth discussion into the suitability of the adopted method, as well as information into the panel selected, can be found in the ESI (Section S3.3†).

Due to commercial confidence, the final weighting parameters cannot be published, however the broader conclusions drawn show feedstock renewability, material, and operating costs to be of the highest relative priority, with the rest holding a near-equal share. Unilever have agreed to the publication of weighted results.

3.3.2 Scenario/sensitivity analysis potential. In terms of a potential scenario analysis, the changing of scenario assumptions within the goal and scope of the assessment will ultimately affect the priority order derived from the weighting survey. Given the rationale of the methodology surrounding the assessment of new products against a defined baseline, the performance figures for each process are not affected by the scenario assumptions. This leads the undertaking of scenario analyses down to simply redoing the SMARTS/SWING survey outlined in Section 3.3.1 with different scenario assumptions.

A worked example of this within the application presented as part of this research could be a scenario in which the electricity of a lower price and greater renewability is made available sooner than predicted, alternatively an “optimistic case”. In these circumstances, the response from survey panellists is likely to react in a way in which the priority of energy demand (indicator 11) decreases. This will ultimately increase the relative priority coefficients of the rest of the indicators, affecting key results and potentially amplifying other indicator scores.

Within the scope of this paper, the key goal is to showcase the methodology as a concept and provide an illustrative example. Given the commercial confidence regarding the sensitivity of these parameters, an illustration of a sensitivity analysis is not provided. Nonetheless the methodology presented does provide the capability to undertake such tasks.

3.4 Baseline selection and definition

Within the defined methodology of the sustainability screening tool is the requirement for a baseline for each indicator, for which a counterfactual assessment can be completed against. The use of a counterfactual assessment has been selected as it

allows for a consistent basis of assessment between individual process assessments, allowing for a fair combination of different process assessments to form overall supply chain assessments. This method also aligns well with the underlying theory behind the screening assessment, stated by Suter *et al.*,¹³ that “Even without predicting absolute magnitudes of effects, application of the concept of risk can lead to substantial improvements in environmental assessment and protection”. Essentially, assessing the probability that an impact exceeds a set benchmark can provide improved assessment accuracy when compared to a methodology centred around the prediction of absolute magnitudes for each impact. In order to progress with this methodology therefore, a baseline for each indicator must be selected and defined.

With most indicators, the appropriate baseline can simply be the current means of production, as reliable data is usually available. There are situations however in which this might not be appropriate, where an alternate baseline value must be considered. For example, the current means of producing surfactant-appropriate olefins utilises 100% fossil feedstocks. It is impossible for this baseline to be exceeded. As a result, when considering feedstock renewability, using this process would be inappropriate as no processes are able to score higher than this and exceed the baseline. Instead, an alternate baseline figure is drafted, more in-line with the Clean Future initiative than the current means of production. This is developed on further in Table 2.

An in-depth look into the baseline selection process can be found in the ESI (Section S3.4†). In short, any qualitative data as part of an indicator baseline is to have a high degree of certainty in order to provide a solid basis of assessment. As shown in subsequent sections, in some cases, indicators may draw different baseline values from different sources as required, such as future climate goals to be met.

3.4.1 Baseline selection for most indicators: dehydrogenation of n-paraffin. Within the context of LAB/LAS production, the dehydrogenation of fossil-based linear paraffins is the most common method of LAS-appropriate olefin production.¹⁵ This method is used alongside, but more than, the Shell Higher Olefin Process,³¹ the dechlorination of chloroparaffins and the cracking of wax to form LAB, as shown in Fig. 5.

The catalytic dehydrogenation of paraffins to olefins has operated for nearly a century, with the first commercial site producing in the late 1930s.³² The process has been through several iterations since, with the UOP Pacol dehydrogenation process proving the most prevalent option with respect to detergent production. A flow diagram is shown in Fig. 6, showing each individual stage of the process.

Given the scope of this study, the “UOP Detergent Alkylate Process” step will not be considered as part of the overall process.

3.4.2 Indicator baseline performances. With the current methods of production outlined, performance notes can be made for the appropriate indicator baselines, which will be considered when assessing prospective technologies. These are given in Table 1. As mentioned previously, the use of the process outlined in Section 3.4.1 as a baseline is not appropriate for all



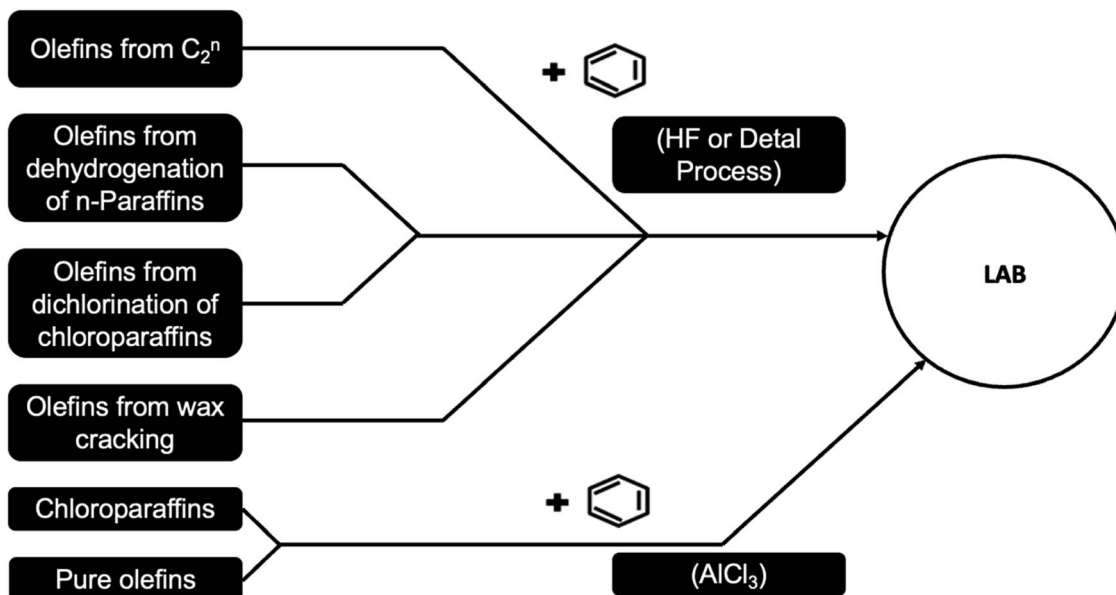

Fig. 5 The most common LAB production methods (adapted from Shokri and Karimi).³

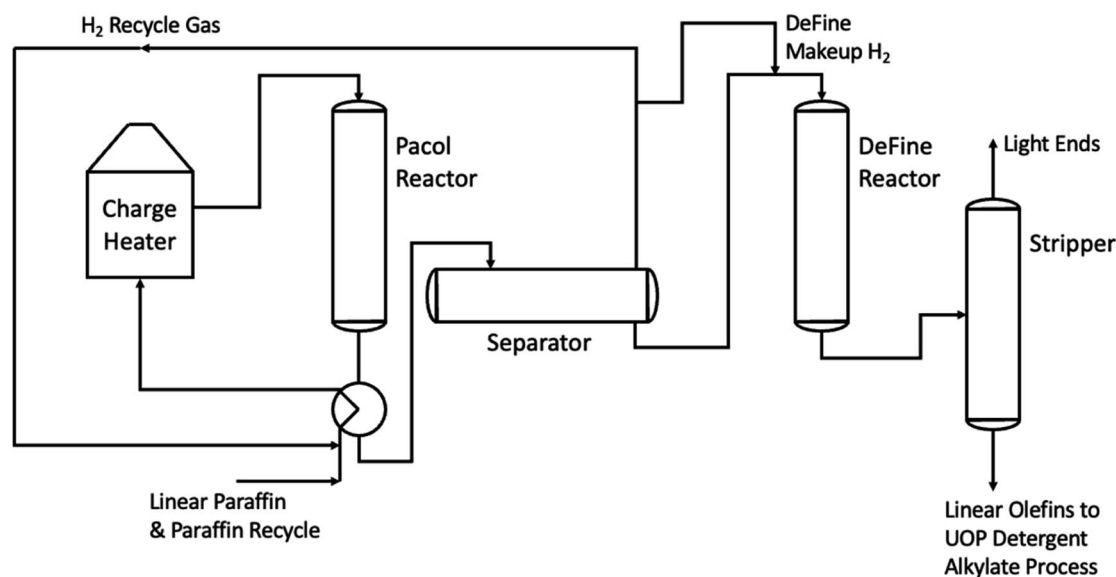

Fig. 6 UOP Pacol dehydrogenation process (adapted from Bhasin *et al.*).⁴

indicators. As a result, alternate baseline sources were drafted for indicators 3, 4 and 5. In-depth discussion and performance notes can be found in the ESU (Section S3.4.2†).

3.5 Undertaking of technology assessments

The undertaking of technology sustainability assessments is intentionally straightforward in its design, in order to allow for the operator's relevant insight to be communicated and calculated to the levels required by a screening assessment. The proposed methodology utilises a five-point Likert scale,³⁸ assessing the probability that the performance level for each indicator exceeds the baseline score outlined in Section 3.4.

Using this score guide shown in Table 2 and corresponding probability curves, the operator then assigns a score of zero to four for each indicator (L_{ij}). This concerns the predicted performance of the assessed technology at the point of deployment. A scale suited to the functional unit of final product is to be used in order for fair construction and comparison of final supply chain assessments. The technological characteristics when assigning performance scores for a given technology are given throughout Section S3.4.2.†

Following this, the final weighted technology sustainability score (S_i) is calculated, using eqn (2). The final score is scaled from 0 to 100, with the lower the score the better the overall sustainability performance.



Table 1 Baseline performance notes for each indicator

Indicator	Baseline performance notes	Sources
(1) CAPEX	Estimated erected cost \$30m USD2016, covering a reactor, subsequent units, land and starting catalyst for a plant of a 100 000 ton per year LAB (~68 000 ton per year LAS-appropriate olefins)	14
(2) Material OPEX	Catalyst cost estimated at 62 USD2021 per ton LAS-appropriate olefins. Paraffin feed estimated at 504 USD2021 per ton LAS-appropriate olefin produced	15 and 33
(3) Process symbiosis	Process is to be largely symbiotic with an external supply chain, resulting in sustainability benefits to the subject technology. This is drafted in line with the key goals of defossilisation outlined by the clean future initiative	3
(4) TRL	TRL 9 – technology must be commercially accessible at the time of deployment	—
(5) Feedstock renewability	Carbon feedstocks are over 50% renewable in order to progress towards net zero clean future targets	3
(6) Arable land use	Small plant footprint with a degree of flexibility. Platinum mining holds a high arable land threat in mining locations	34
(7) Ecosystem depletion	Use of fossil materials hold large share of abiotic depletion potential. Ecosystem depletion threat as a result of catalyst mining, such as production of acidic waters	35
(8) Overhead OPEX	Spent catalyst management processes required, though catalyst regeneration rates “very low”. Fire extinguishing measures required due to flammable material handling. Estimated at 48 USD2021 per ton of LAS-appropriate olefin formed. Labour costs assumed to be standard to industry	33
(9) Energy demand	215 kW h medium voltage electricity and 9.32 GJ heat energy required per ton LAS-appropriate olefins. 57% of total energy used for conversion of paraffins to olefins, the rest on production of paraffin feedstocks	31 and 36
(10) Social impacts	Reliance on extensive control measures to dampen impacts. Social impacts present throughout entire feedstock production process. Relevant social impacts listed above	37
(11) Supply chain risk	Reliance on “high risk” platinum in catalysts – 7.6/10 according to British Geological Survey. Reliance on fossil feedstocks, falls outside of clean future initiative. Threat of fossil carbon taxation limiting viability as a future supply chain option. Strong geopolitical influence, as evidenced by the Russo-Ukrainian war	3, 18 and 35

$$S_i = \frac{100}{4} \sum_j^i L_{ij} a_{ij} \quad (2)$$

3.6 Supply chain assessments – combining technology assessments

With sustainability performance scores now generated for each technology within the supply chain network, the combination of individual scores can now be combined together to form supply chain assessments. As with other sustainability assessments, the conclusions drawn from the sustainability assessment draw much further from just the consultation of a single score. Within the methodology, weighted screening results within a supply chain can be presented in a spider diagram, with clear highlights as to where the key green- and red-flags are in terms of supply chain viability. An example is presented for Supply Chain SJ (referenced in Fig. 7), in Fig. 8. From the diagram, outstanding values highlight how the lack of feedstock renewability greatly withholds the process from improved performance, with higher scores representing negative impacts on process viability. Due to commercial confidence, as mentioned in Section 3.3, the full weighted results for this application cannot be disclosed, however Fig. 8 does provide an illustration as to how the final, granular results of an individual supply chain study looks.

These insights are one of the key outcomes from the screening tool, with entire supply chains or technologies approved or rejected for further assessment (such as LCA and

TEA) by decision-makers. Despite this however, individual scores can in fact be combined as to provide numerical scores for the entire supply chain.

The basis for this combination to provide a single score is to take an average of the relevant technology scores within a given supply chain. Given that each technology sustainability score has equal cardinality, the issues typically associated with an “average of averages” case is avoided.³⁹ This is to dissociate supply chain scores from the quantity of technologies within the assessed supply chain, as each technology has already been calculated at an appropriate scale, as mentioned in Section 3.5. One drawback from this method is the potential to overlook compounding effects associated with having more processes within a supply chain, such as with results pertaining to economic sustainability. This outlines an associated drawback with the compounding methodology and justifies how the key outcome of the screening assessment is the hot spotting as mentioned before.

Whilst computational methods do already exist to find the optimum route, such as Edmond’s Algorithm,³⁹ having a list of every route’s performance is beneficial in order to understand commonalities and trends between supply chains and allow for expanded interpretation of results. Supply chain sustainability scores (S_c) follow the same 0 to 100 scaling as those described in Section 3.5, with the lower the score the better with respect to overall sustainability performance. The diagram shown in Fig. 3 has been relabelled with supply chains A through R (Fig. 7), for

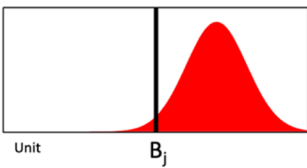
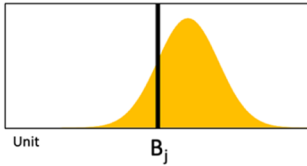
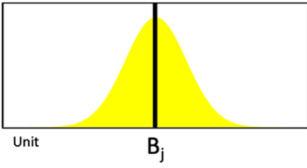
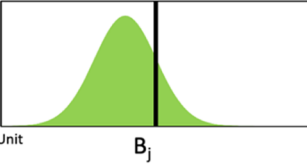
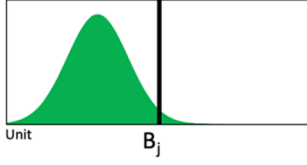

Table 2 Score guides for indicator performance. NB scoring guide may be inverted if exceeding of baseline of benefit to sustainability

Scoring guide	Score	Probability curve
Highly likely to exceed baseline	4	 Unit B_j
Likely to exceed baseline	3	 Unit B_j
Neither likely nor unlikely to exceed baseline	2	 Unit B_j
Unlikely to exceed baseline	1	 Unit B_j
Highly unlikely to exceed baseline	0	 Unit B_j

better illustration as to show which supply chains have been assessed as part of this study. This information is also summarised in Table 3.

4 Results

4.1 Technology assessment results

Within the results section, both the unweighted technology assessments and weighted final supply chain results can be published. A summary table of the individual technology sustainability scores (L_{ij}) is shown in Table 4, with added information, sources and justifications for scores given in the ESI document (Tables S1–S18 and Section S4.1†).

4.2 Supply chain assessment results

Taking the weighted sustainability scores for each technology assessed, the final supply chain assessments can be undertaken, giving an overall insight into the sustainability viability for each supply chain assessed. These scores are shown in Fig. 9. The supply chain numbers follow those outlined in Table 4. The application of the Unilever weightings has been approved by Unilever, who agree to use it for this publication.

5 Discussion

5.1 Assessment performance

The methodology used was developed with the idea of gaining an understanding of process sustainability through consideration of both quantitative and qualitative process characteristics, distancing the assessment from the uncertainty associated with ex-ante data. This is not to suggest that the final results are free from uncertainty, rather that they hold a lower potential for effects from uncertainty, in line with conclusions drawn by Suter *et al.*¹³ This in whole fulfils the key aims of the research outlined in Section 2.4, with the avoidance of absolute impact prediction and use of a counterfactual baseline assessment resulting in a complete viability study, identifying red- and green-flags for each process and supply chain. This also directly addresses the limitations of existing screening tools identified within the review of the literature in Section 2.3, with conclusions drawn under the stipulation of highly limited discrete data availability.

The case study applied to the methodology outlined proved its functionality and potential to provide results and trends which could help inform decision-makers on the viability of



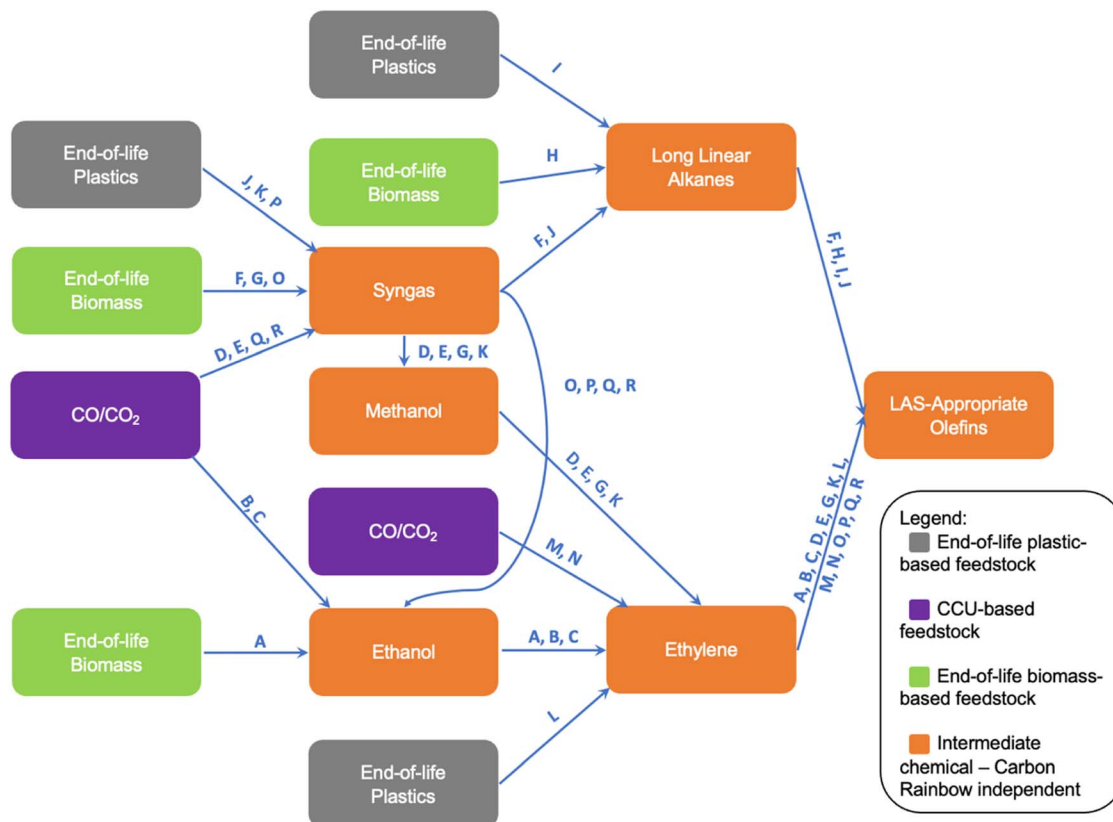

Fig. 7 Labelled supply chain route diagram (adapted from Platt and Styring).²

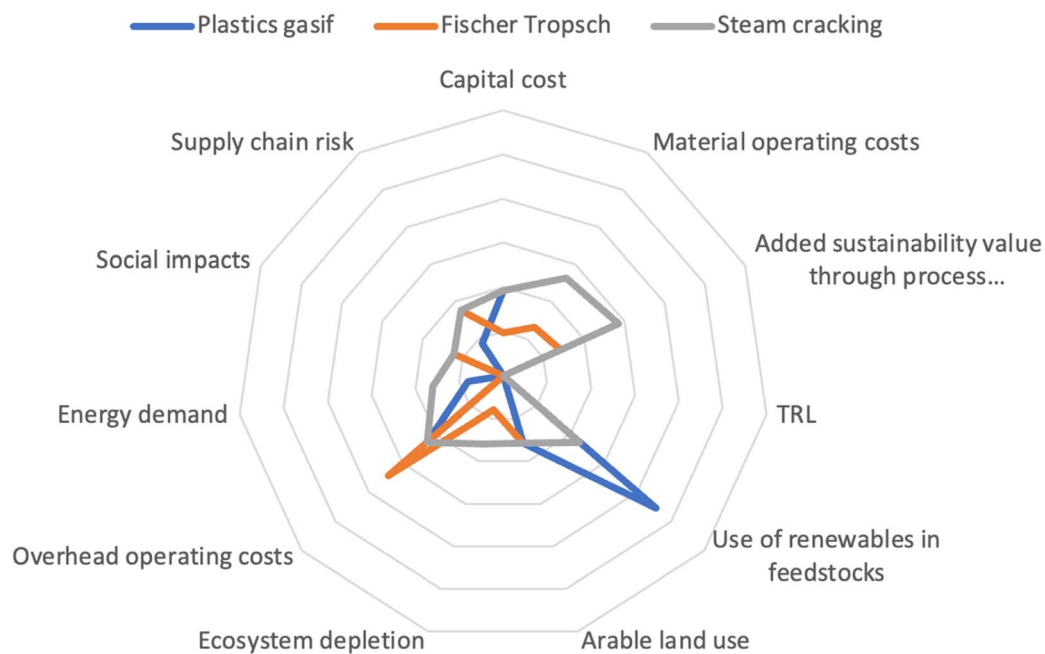

Fig. 8 Sample spider diagram showing weighted impact results for supply chain SJ, concerning the gasification and FT synthesis of plastics (axis concealed to hide discrete priority factors).



Table 3 Descriptions of each of the defossilised supply chains assessed

Route label	Technologies used	Route description
SA	T1, T12, T17	Fermentation of second-generation biomass to ethanol, which is then dehydrated and oligomerised
SB	T8, T12, T17	Fermentation of direct air capture (DAC)-sourced CO ₂ to ethanol, which is then dehydrated and oligomerised
SC	T9, T12, T17	Fermentation of point source capture (PS)-sourced CO ₂ from a steel mill to ethanol, dehydrated and oligomerised
SD	T6, T10, T13, T17	Formation of olefins from DAC-sourced methanol <i>via</i> reduction and water-gas shift reaction
SE	T7, T10, T13, T17	Formation of olefins from steel mill PS-sourced methanol <i>via</i> reduction and water-gas shift reaction
SF	T2, T11, T16	Fischer–Tropsch synthesis of gasified end-of-life biomass
SG	T2, T10, T11, T17	Formation of olefins from biosyngas-derived methanol <i>via</i> water-gas shift reaction
SH	T3, T16	Cracking/dehydrogenation of pyrolysis oil from end-of-life biomass pyrolysis
SI	T4, T17	Cracking/dehydrogenation of pyrolysis oil from end-of-life plastics pyrolysis
SJ	T5, T10, T17	Fischer–Tropsch synthesis of gasified end-of-life plastics
SK	T5, T10, T13, T17	Formation of olefins from end-of-life-plastics-derived methanol <i>via</i> gasification, before water-gas shift reaction
SL	T4, T17	Oligomerisation of ethylene sourced from direct pyrolysis of end-of-life plastics
SM	T14, T17	Direct reduction of DAC-sourced CO ₂ to ethylene and subsequent oligomerisation
SN	T15, T17	Direct reduction of PS steel mill-sourced CO ₂ to ethylene and subsequent oligomerisation
SO	T2, T18, T12, T17	Dehydration and oligomerisation of ethanol, directly sourced from treatment of gasified end-of-life biomass
SP	T5, T18, T12, T17	Dehydration and oligomerisation of ethanol, directly sourced from treatment of gasified end-of-life plastics
SQ	T6, T18, T12, T17	Dehydration and oligomerisation of ethanol, directly sourced from treatment of reduced DAC-sourced CO ₂ and H ₂
SR	T7, T18, T12, T17	Dehydration and oligomerisation of ethanol, directly sourced from treatment of PS steel mill-sourced CO ₂ and H ₂

different supply chains and technologies during the transition to a defossilised supply network. The undertaking of this assessment also provides the first major iteration and groundwork for a “living document”. Assessors can add new technologies and supply chains, alter technological performance scores as new literature is published, and also update the weighting prevalence of indicators as the future operating scenario becomes clearer, particularly with respect to energy costs and grid composition, as well as material costs and availability. This therefore provides an opportunity for the stakeholder to maintain a bank of supply chain viability evidence, as well as a series of sustainability performance results, showing and justifying which supply chains hold the most potential.

5.2 Application to defossilised olefins

Overall, 18 defossilised routes were assessed with due comparison to sustainability performance relative to a series of baseline figures for 11 sustainability indicators. As can be seen in Fig. 7 and 9, as well as the corresponding descriptions in Table 4, the best performing routes fell under the “green” (from plants) and “grey” (from plastic waste) carbon feeds, as characterised by the carbon rainbow in Fig. 1. This coincides with generally beneficial economic performance associated with material costs and energy demand, as well as lower capital expenditure for new industrial developments. With respect to green feedstocks, concerning end-of-life biomasses, the benefit of carbon renewability is also an influential factor.

As alluded to in Section 3.3, the renewability of feedstocks is one of the indicators with the highest weighting. This, teamed with the binary nature of renewability (where technologies largely scored 0 or 4), tended to have quite a significant impact on individual technology performance and a subsequent effect on supply chain performance. Other key performance factors include the greater likelihood of market readiness by 2030 for these technologies, with processes like gasification and Fischer–Tropsch synthesis (and to a lesser extent pyrolysis) already being performed at scales close to those required within the scenario of this assessment, with Fulcrum Bioenergy⁴⁰ proving these processes can be done commercially with the opening of their Sierra BioFuels plant in December 2022.⁴¹

The best two performing supply chains both also incorporate gasification of some form. With the autothermal nature of gasification, the exothermic processing of its products, and the low-cost of feedstocks and plant, gasification excelled as an individual technology (T2 and T5).

Despite the significant weighting associated with feedstock renewability, several supply chains utilising non-renewable feedstocks still performed relatively well from a single score basis. The grey supply chains, specifically SI, SK and SL, all had performance scores which exceeded those of a purple feedstock origin, even those with renewable CO₂ sources.

Looking at the other end of the results sheet, the lower performing routes tended to be those associated with purple feedstocks, both from direct air capture and point sources. This



Table 4 Technology sustainability performance results summary

Technology (Number reference from Figure 3)																			
	T1	T2	T3	T4	T5	T6	T7	T8	T9	T10	T11	T12	T13	T14	T15	T16	T17	T18	
1) CAPEX	3	2	3	2	2	4	4	4	4	2	1	3	2	4	4	2	2	4	
2) Mat. OPEX	4	3	3	1	2	4	4	4	4	1	1	2	3	4	4	2	2	4	
3) Symbiosis	0	0	0	4	4	4	0	4	0	4	2	4	3	3	0	4	4	2	
4) TRL	2	1	2	0	0	3	3	3	3	0	0	1	1	4	4	0	0	4	
5) Feed. Renew.	0	0	0	4	4	0	4	1	4	2	2	2	2	0	4	2	2	2	
6) Arable land use	4	4	4	2	2	2	2	2	2	2	2	2	2	2	2	2	2	2	
7) Ecosys. Depl.	3	3	3	0	0	3	3	3	3	2	1	2	1	3	3	2	2	3	
8) Overhead OPEX	2	2	1	1	2	3	3	3	3	2	3	4	3	4	3	2	2	2	
9) Energy demand	2	1	3	4	1	4	3	4	3	1	0	2	2	4	4	2	2	2	
10) Social impacts	1	1	1	0	0	3	2	3	2	2	2	2	2	4	4	2	2	2	
11) Supply risk	1	0	1	1	1	4	4	4	4	2	2	3	3	4	4	2	2	4	

was generally due to the poor economic performance when compared to the indicator baseline figures, with expensive plant, materials, and high energy demands all contributing to relatively poor performance. This is shown in Table 4, with every

CCU-based technology highly likely to perform on the poor side of the baseline with respect to energy usage.

The case study also provided, as previously mentioned, an insight into the sustainability priorities for the stakeholder.

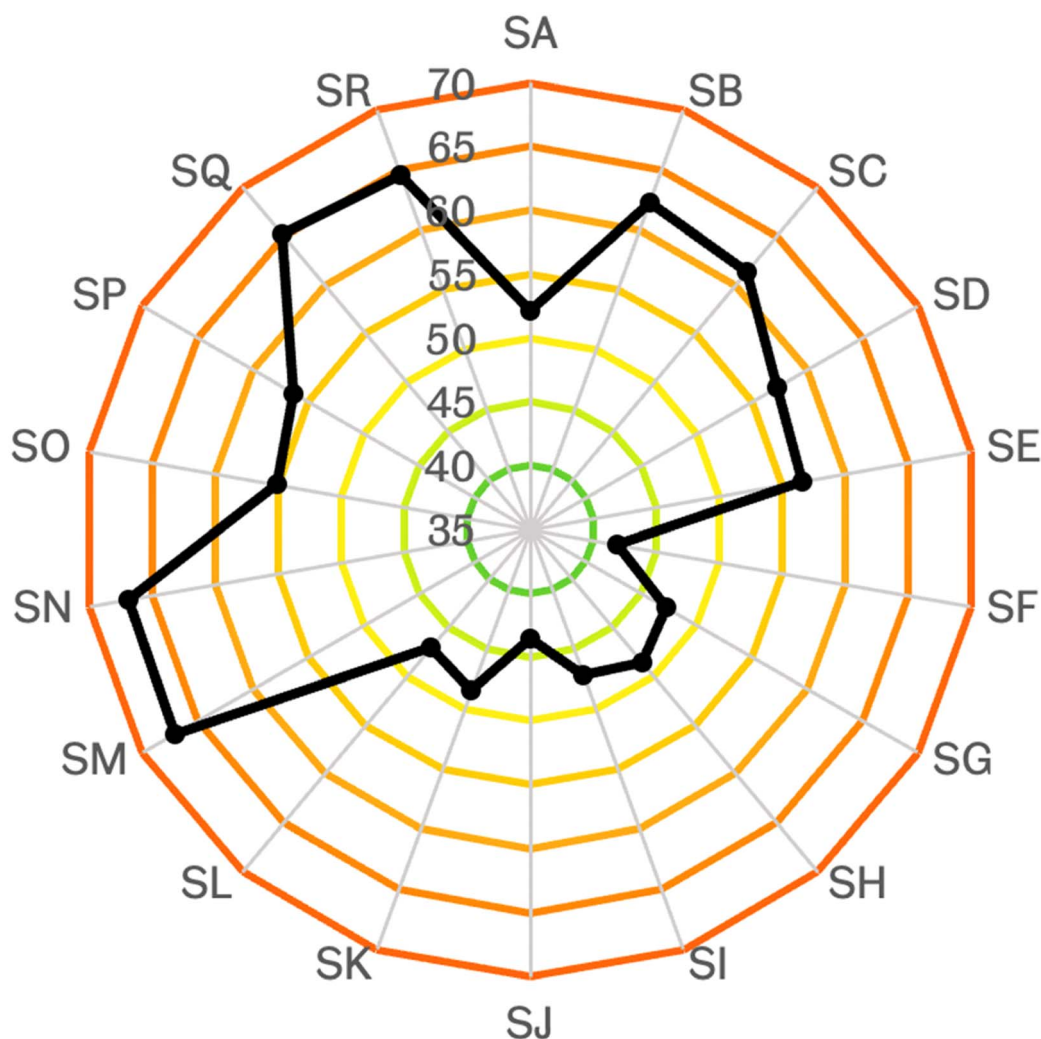

Fig. 9 Results from supply chain sustainability assessment for the defossilised routes outlined in Fig. 7.



This insight, through numerical justification, allows the stakeholder to focus on key technological characteristics when deciding on which supply chains and technologies to invest in.

As a result of this screening therefore, the operator and assessment results both imply that further sustainability assessment into routes F through K would theoretically provide the stakeholder with the optimum defossilised supply chain from those assessed, for application within the defined scenario (Section 3.1).

6 Conclusions and future work

As part of the assessment of supply chain validity for the defossilisation of olefin supply chains for Unilever Home Care, a counterfactual screening methodology was developed and applied to an extensive network of potential supply chains for the formulation of defossilised LAS-appropriate olefins. The assessment of these olefins is driven by the Clean Future and Carbon Rainbow initiatives,³ as well as addressing wider implications surrounding sustainable production, such as the Paris Agreement¹ and the AISE Charter for Sustainable Cleaning.⁴

Through the assessment process, eleven different sustainability indicators were identified, each with the aim of addressing one of the three pillars of sustainability (environmental, economic, and social effects). A SMARTS-adjacent weighting survey was undertaken as a means of better tailoring the results to the stakeholder, proving the three highest priority indicators to be the use of renewable feedstocks, the material costs and the overhead operating expenditure associated with each of the technologies. A “baseline” of indicator success was then defined for each indicator, giving a performance value associated with optimal indicator performance. Each technology was then assessed according to these indicators, with a score (from a Likert scale) given based on the probability of the prospective technologies achieving the baseline performance for each indicator. These indicator performance scores, weighted by the importance parameters from the sustainability priority survey, were then summated to give a sustainability score for each technology. The technology sustainability scores were then combined through an arithmetic mean to give supply chain sustainability scores for eighteen different prospective supply chains.

From these results, important trends and similarities were identified for each of the better performing routes, with “grey” and “green” feedstock routes (as categorised by the carbon rainbow) outperforming many of the “purple” routes. This was driven largely by the superior economic performance of the grey and green routes, as well as the use of renewable feedstocks in the green routes. These trends could provide vital evidence when planning future sustainability and supply chain validity assessments, potentially streamlining future work by screening out poorer-performing routes.

When considering future work, a validation of results through co-reported, ISO-complying LCAs and TEAs of an array of supply chains, in order to confirm as to whether the conclusions drawn from the screening align with the industry

norm. Given the lack of standardisation surrounding Social Impact Assessment (SIA), as well as a lack of differentiation between many of the routes, the pursuit of SIA validation will not be taken beyond the screening. This is also backed by the Unilever Responsible Partners Policy,²⁸ with only policy-compliant technologies being taken forward for assessment. The undertaking of this assessment also gave a first iteration of a “living document”, which will be maintained and updated as technological development changes over time, as well as any other external changes to the future scenario, which may vary sustainability priorities.

Further applications of the methodology to different ingredients within Unilever’s supply chains are also a key element to furthering this research. Given the fact that the methodology outlined is generalised for sustainability screening, the potential breadth of application is very broad. Returning a focus of research back to the identification of other key contributors to fossil supply chains within Unilever’s chemical supply chains will lead to further applications of this methodology, contributing further to the wider goals outlined by the Clean Future and Carbon Rainbow initiatives.

Author contributions

EP is primary author. PS is research supervisor and edited the manuscript. Both authors contributed to the article and approved the submitted version.

Conflicts of interest

While the PhD scholarship is funded by Unilever, the project undertaken is independent of commercial workflows. This is presented as a general methodology for a general audience and is not specific to Unilever. As a result, there are no conflicts to declare.

Acknowledgements

We are grateful to Unilever for funding EGP as a PhD Scholar from a Strategic Partnership with PS at the University of Sheffield. We are also grateful to the UKRI Engineering and Physical Sciences Research Council (EPSRC) for funding to PS under the UKRI Interdisciplinary Centre for Circular Chemical Economy award (EP/V011863/1). The authors would like to acknowledge Dr Katy Armstrong, Dr Alastair Sanderson, and Dr Chris Gibbs of Unilever PLC who have engaged in discussions inspiring this work.

Notes and references

- 1 UNFCCC, *Paris Climate Change Conference – November 2015*, 2015.
- 2 E. G. Platt and P. Styring, *Front. Sustain.*, 2022, **3**, 1057491.
- 3 Unilever, Clean Home Clean Planet Clean Future, <https://www.unilever.com/brands/home-care/clean-future/>, accessed August 1, 2023.



- 4 AISE, Charter for Sustainable Cleaning - AISE, <https://www.aise.eu/our-activities/sustainable-cleaning-78/charter-for-sustainable-cleaning-2874.aspx>, accessed November 16, 2023.
- 5 M. Kravchenko, D. C. Pigosso and T. C. McAloone, *J. Cleaner Prod.*, 2019, **241**, 118318.
- 6 R. Chauvy, N. Meunier, D. Thomas and G. De Weireld, *Appl. Energy*, 2018, **236**, 662–680.
- 7 D. Miller, K. Armstrong and P. Styring, *Sustain. Prod. Consum.*, 2022, **32**, 184–197.
- 8 M. Kravchenko, PhD thesis, Technical University of Denmark, 2020.
- 9 T. L. Saaty, *J. Math. Psychol.*, 1977, **15**, 234–281.
- 10 C. L. Hwang, Y. J. Lai and T. Y. Liu, *Comput. Oper. Res.*, 1993, **20**, 889–899.
- 11 E. Mastrocinque, F. J. Ramírez, A. Honrubia-Escribano and D. T. Pham, *Expert Syst. Appl.*, 2020, **150**, 113321.
- 12 S. A. Khan, A. Chaabane, F. T. Dweiri, S. A. Khan, A. Chaabane and F. T. Dweiri, *Multi-Criteria Decision-Making Methods Application in Supply Chain Management: A Systematic Literature Review*, IntechOpen, 2018.
- 13 G. W. Suter, L. W. Barnthouse and R. V. O'Neill, *Environ. Manage.*, 1987, **11**, 295–303.
- 14 R. A. Meyers, *Handbook of Petroleum Refining Processes*, McGraw Hill Education, 4th edn, 2016.
- 15 A. Shokri and S. Karimi, *Russ. J. Appl. Chem.*, 2021, **94**, 1546–1559.
- 16 M. Barrow, B. Buckley, T. Caldicott, T. Cumberlege, J. Hsu, S. Kaufmann, K. Ramm, D. Rich, W. Temple-Smith, C. Cummis, L. Draucker, S. Khan, J. Ranganathan and M. Sotos, *Technical Guidance for Scope 3 Emissions (Version 1.0)*, 2013.
- 17 Science Based Targets, *SBTi Criteria and Recommendations*, 2020.
- 18 vbw, Strompreisprognose, 2022.
- 19 United Nations, THE 17 GOALS | Sustainable Development, <https://sdgs.un.org/goals>, accessed August 1, 2023.
- 20 D. R. G. de Faria, J. L. de Medeiros and O. Q. F. Araújo, *J. Cleaner Prod.*, 2020, **278**, 123966.
- 21 A. J. K. Newman, G. R. M. Dowson, E. G. Platt, H. J. Handford-Styring and P. Styring, *Front. Energy Res.*, 2023, **11**, 1124072.
- 22 A. W. Zimmermann and R. Schomäcker, *Energy Technol.*, 2017, **5**, 850–860.
- 23 T. Langhorst, L. Cremonese, J. Wunderlich, A. Kätelhön, H. Naims, C. Mangin, B. Olfe-Kräutlein, S. McCord, M. Bachmann, T. Strunge, A. Marxen, M. Bachmann, B. Winter, F. Mason, P. Styring, A. Zimmerman, Y. Wang, K. Armstrong, A. Sternberg, D. Rokosch, G. Stokes, R. Schomäcker, L. Müller, A. Villa Zaragoza, G. Buchner, S. Michailos, G. Faber, E. Williams, A. Bardow and V. Sick, *Techno-Economic Assessment & Life Cycle Assessment Guidelines for CO2 Utilization*, 2022, vol. 2.
- 24 B. Vidal-Legaz, S. Sala, A. Antón, D. M. De Souza, M. Nocita, B. Putman and R. F. M. Teixeira, *Land-use Related Environmental Indicators for Life Cycle Assessment - Analysis of Key Aspects in Land Use Modelling - Study*, 2016.
- 25 British Standards Institution, *BS EN ISO 14044:2006+A2:2020*, London, 2021.
- 26 A. Baral and B. R. Bakshi, *Environ. Sci. Technol.*, 2010, **44**, 800–807.
- 27 M. H. Abbasi, B. Abdullah, M. W. Ahmad, A. Rostami and J. Cullen, *Sustain. Energy Technol. Assess.*, 2021, **48**, 101630.
- 28 Unilever, *Responsible Business Partner Policy*, 2022.
- 29 S. Cox, P. Gagnon, S. Stout, O. Zinaman, A. Watson and E. Hotchkiss, *Distributed Generation to Support Development-Focused Climate Action*, 2016.
- 30 W. Edwards and F. H. Barron, *Organ. Behav. Hum. Decis. Process.*, 1994, **60**, 306–325.
- 31 G. Wernet, C. Bauer, B. Steubing, J. Reinhard, E. Moreno-Ruiz and B. Weidema, *Int. J. Life Cycle Assess.*, 2016, **21**, 1218–1230.
- 32 M. M. Bhasin, J. H. McCain, B. V. Vora, T. Imai and P. R. Pujadó, *Appl. Catal., A*, 2001, **221**, 397–419.
- 33 R. A. Meyers, *Handbook of Petroleum Refining Processes*, McGraw Hill Education, 3rd edn, 2004.
- 34 G. Baskaran, *Miner. Econ.*, 2021, **34**, 385–398.
- 35 British Geological Survey, *Risk List 2015 - an Update to the Supply Risk Index for Elements or Element Groups that Are of Economic Value*, 2015, vol. 1.
- 36 M. Franke, J. L. Berna, L. Cavalli, C. Renta, M. Stalmans and H. Thomas, *Tenside, Surfactants, Deterg.*, 1995, **32**, 384–396.
- 37 D. O'Rourke and S. Connolly, *Annu. Rev. Environ. Resour.*, 2003, **28**, 587–617.
- 38 R. Likert, *Arch. psychol.*, 1932, **22**, 5–55.
- 39 A. Rajkumar, K. Mukherjee and T. Tulabandhula, *Proceedings of the International Joint Conference on Autonomous Agents and Multiagent Systems*, AAMAS, 2018, vol. 1, pp. 574–582.
- 40 Fulcrum Bioenergy, Our Fuel Process, <https://www.fulcrum-bioenergy.com/our-fuel-process>, accessed August 1, 2023.
- 41 Fulcrum BioEnergy, Fulcrum BioEnergy Successfully Produces First Ever Low-Carbon Fuel from Landfill Waste at its Sierra BioFuels Plant, <https://www.fulcrum-bioenergy.com/news-resources/first-fuel-2-2>, accessed August 1, 2023.

